



RÉPUBLIQUE
FRANÇAISE

*Liberté
Égalité
Fraternité*



FRENCH SPACE
INDUSTRY
CAPABILITIES
CATALOGUE

CATALOGUE
DES CAPACITÉS
DE L'INDUSTRIE
SPATIALE FRANÇAISE

FRENCH SPACE INDUSTRY CAPABILITIES CATALOGUE

Page intentionally left blank

CATALOGUE DES CAPACITES DE L'INDUSTRIE SPATIALE FRANCAISE

→ <https://cnes.fr/entreprises/catalogue-industrie-spatiale>

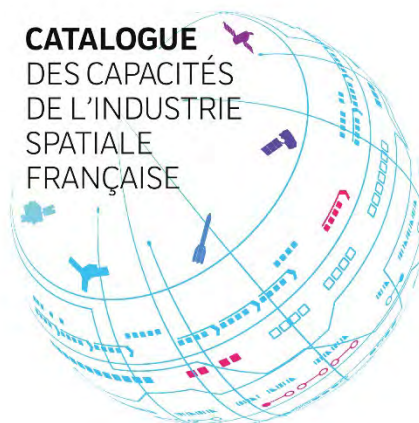

EDITORIAL

Avec l'essor des nouvelles technologies du numérique et du « Newspace », de nombreux domaines d'application du spatial sont en pleine évolution, tels l'environnement, les télécommunications, les transports, la mobilité ou la santé. Dans ce contexte où l'on voit émerger de nouveaux acteurs publics ou privés, et face à des enjeux majeurs à la fois sociétaux, scientifiques ou de souveraineté nationale, l'Europe reste fermement installée dans le trio de tête des puissances spatiales, derrière les Etats-Unis et bien souvent devant la Chine.

La France est le moteur historique de ce succès européen, avec un secteur spatial particulièrement performant, dans lequel le CNES articule et irrigue les mondes de la recherche et de l'industrie.

Grâce à une politique industrielle volontariste, menée depuis plus d'un demi-siècle, en s'appuyant sur des investissements publics ciblés, notre pays dispose d'une industrie spatiale compétitive de très haute technologie, pourvoyeuse d'emplois, avec des compétences multiples, allant des grands maîtres d'œuvre industriels, des entreprises de taille intermédiaire, aux très nombreuses PME ou startups. Cette industrie représente aujourd'hui des dizaines de milliers d'emplois hautement qualifiés directement liés au spatial, soit plus du tiers des emplois en Europe, et génère environ la moitié du chiffre d'affaires dégagé par le secteur spatial européen.

Le CNES a le plaisir de publier ce catalogue des capacités de l'industrie spatiale française. Ce dernier est destiné à promouvoir l'écosystème français. Il s'agit de favoriser le réflexe France auprès des partenaires français et internationaux et de contribuer ainsi au succès de nos industriels sur les marchés à l'export. Avec plus de 250 entreprises déjà référencées, et une fonctionnalité de recherche de compétences accessible en ligne, c'est un outil de « sourcing » unique pour trouver le prestataire ou le partenaire disposant de l'expertise ou de la capacité de développement attendue.

Agences spatiales, laboratoires scientifiques et industriels, nous inventons l'espace de demain !

FRENCH SPACE INDUSTRY CAPABILITIES CATALOGUE

→ <https://cnes.fr/en/entreprises/catalogue-industrie-spatiale>



EDITORIAL

With the surge in new digital technologies and New Space, many applications served by space—like for example the environment, telecommunications, transport, mobility and healthcare—are undergoing deep transformations. At a time when new public and private players are coming onto the scene and we are facing major social, scientific and national sovereignty challenges, Europe remains steadfastly in the world’s top three space powers, behind the United States and very often ahead of China.

France has historically played a driving role in this European success story, through a particularly vibrant space sector in which CNES shapes and irrigates research and industry.

Thanks to a proactive industrial policy pursued over the course of more than half a century and sustained by targeted government investments, our nation has built a competitive high-tech space industry providing jobs and a broad palette of skills, spanning large primes, mid-tier firms and numerous SMEs and start-ups. This industry today supports tens of thousands of highly skilled jobs directly connected to space, accounting for more than a third of all jobs in Europe and nearly half of European space sector revenues.

CNES is pleased to publish this catalogue of French space industry capabilities. It is designed to promote the French ecosystem and to encourage partners at home and abroad to “think France”, thus helping our manufacturers to succeed in export markets. With more than 250 firms already listed and its online skill search feature, the catalogue is a unique sourcing tool to find the expertise or development capabilities you are looking for.

Together, we space agencies, research laboratories and industry contractors are inventing the future of space!

Philippe Baptiste, CNES Chairman & CEO, 15 February 2024

LIST OF COMPANIES

[If your company is not referenced below → contact us at catalogue.industrie@cnes.fr](mailto:catalogue.industrie@cnes.fr)

3D PLUS (HEICO)	CAP GEMINI TECHNOLOGY SERVICES	GEO4I
3DCERAM-SINTO	CEDRAT TECHNOLOGIES	GEOMATYS
ABBIA GNSS TECHNOLOGIES	CERFACS	GISAIA
ABSOLUT SENSING	CES WORKS	GMV INNOVATING SOLUTIONS
ABSOLUT SYSTEM	CGI FRANCE DEFENSE ET SPATIAL	GRASP
ACRI ST	CIBEL (ACB)	GREENERWAVE
ACTIA AEROSPACE (DINARD)	CILAS	GROUPE ADF
ACTIA AEROSPACE (TOULOUSE)	CIO INFORMATIQUE INDUSTRIELLE	GUIDE
AD INDUSTRIES (MS COMPOSITES)	CLIX INDUSTRIES	HARRIS GEOSPATIAL SOLUTIONS
ADDUP (ex POLY-SHAPE)	CNIM SYSTEMES INDUSTRIELS	HEATSELF
ADVEOTEC	CLS	HEMERIA
AFC-STAB	COMAT	HEMERIA AIRSHIP
AGENIUM SPACE	COREDUX FRANCE	HENSOLDT SPACE CONSULTING
AGILINK MICROWIRES	CREATIVE EUROCOM	HIONOS
AIKOSPACE	CS GROUP	HOTBLOCK ON BOARD
AIRBUS DEFENCE AND SPACE	CT INGENIERIE	HUMAN DESIGN GROUP
AIRBUS ONEWEB SATELLITES	CYBERINFLIGHT	HYGEOS
AIRBUS PROTECT	CYSEC	ICEBERG (ORBITAL VIEWS)
AIRMEMS	DACTEM INTERNATIONAL	INDEPENDENT LIVING BASE
AKKA I&S	DASSAULT AVIATION	INFINITE ORBITS
ALCADIA ENTREPRISES	DYCSYT	INMIND-VR
ALDORANE	EASii IC	INTERAC
ALLIANCE4U	EGIDE	INTRASPEC TECHNOLOGIES
ALTEN	EIFFAGE ENERGIE SYST - CLEMESSY	ION-X
ALTER TECHNOLOGY TUV NORD	ELEMCA	ISP SYSTEM
AMCAD ENGINEERING	ENVIRPROD (ARMELIO)	JFB SPACE CONSULTING
AMETRA	EREMS	JV GROUP
ANYWAVES	E-SPACE	KAYRROS
APAVE SUD EUROPE - ESQS	ESSP	KERDRY
AREELIS TECHNOLOGIES	ETIENNE LACROIX TOUS ARTIFICES	KINEIS
ARIANE GROUP	EUROCONSULT	KRATOS COMMUNICATIONS
ARKANE	EUROPROPULSION	LATELEC (LATECOERE)
ARMOR ARSENAL	EUROSATCOM	LATESYS
ASB AEROSPATIALE BATTERIES	EUTELSAT	LATITUDE
ASTREOS	EVERSAT	LISI AEROSPACE AM
ATEM	EXAIL	LOFT ORBITAL TECHNOLOGIES
ATLANTEC (ACB)	EXAIL AEROSPACE	M3 SYSTEMS
ATMOSTAT (ALSYMEX, ALCEN)	EXENS SOLUTIONS (ex COBHAM)	MAGELLIUM (ARTAL GROUP)
ATOS	EXOTRAIL	MAIASPACE (ARIANE GROUP)
AUREA TECHNOLOGY	EXPLEO	MAP SPACE COATINGS
AVANTIS TECHNOLOGY	EXXELIA	MATRA ELECTRONIQUE
AXON CABLE	FDC	MECANO ID
BERTIN ALPAO	FLEURET	MEDES
BERTIN TECHNOLOGIES	FLUCTUS	MEDYSYS
BLACKLEAF	FLYING WHALES	MELIAD
CAILABS	GAEL SYSTEMS	MERSEN BOOSTEC
CALLISTO	GAMA	

METRAVIB (ACOEM)	SCALIAN	TERNWAVES
MICRONOR	SCASSI CONSEIL	THALES ALENIA SPACE
MICROTEC	SCIENTEAMA	THALES DIS SERVICES
MIRATLAS	SECTOR	THALES SERVICES NUMERIQUES
MVG INDUSTRIES	SEGULA TECHNOLOGIES	THALES SESO
NANOXPLORE	SELHA	THE EXPLORATION COMPANY
NERYS	SEREME	THERMOCOAX
NEX VISION	SERMA MICROELECTRONICS	THIOT INGENIERIE
NEXIO	SERMA TECHNOLOGIES	THRUSTME
NEXTER MUNITIONS	SHARE MY SPACE	TIMELINK MICROSYSTEMS
NICOMATIC	SILICOM	TRAD
NIMESIS TECHNOLOGY	SILIOS TECHNOLOGIES	TRONICO (ALCEN)
NOVELTIS	SMAC	UMS
NUMERISAT	SODERN ARIANE GROUP	U-SPACE
OMEGA SYSTEMES ATLANTIQUE	SODITECH INGENIERIE	VENTANA (NEXTEAM GROUP)
OPUS AEROSPACE	SOGECLAIR AEROSPACE	VIGNAL ARTRU INDUSTRIES (GMP GROUP)
PANGEA AEROSPACE	SOKARIS INGENIERIE	VISHAY (SFER)
PARSIMONI	SOPEMEA	VISIOTERRA
PCB PIEZOTRONICS	SOPHIA	VIVERIS TECHNOLOGIES
PHOTONIS	SOTEREM	WATT ET WELL
PIXSTART	SOTREM SEO	WEEROC
PLUG'IN	SPACEBEL	
POSITHOT	SPACEDREAMS	
PRELIGENS (EARTHCUBE)	SPACELOCKER	
PROCUREEZY	SPACEPHARMA	
PROMETHEE EARTH INTELLIGENCE	SPARTAN SPACE	
PYROALLIANCE (ARIANE GROUP)	SPHEREA	
PYTHEAS TECHNOLOGY	SPIRIT TECHNOLOGIES	
R.TECH	STEEL ELECTRONIQUE (ACTIA)	
RADIALL	STIRWELD	
RAKON FRANCE	STMICROELECTRONICS	
REAL DREAM	SYLPHAERO	
RESA	SYMETRIE	
RESCOLL	SYNTONY	
RHEA GROUPE	SYRLINKS (SAFRAN)	
RIDE!	SYSTRONIC (CIMULEC)	
R-TIME	TECALEMIT AEROSPACE	
SAFRAN AIRCRAFT ENGINES	TECALEMIT TUBES	
SAFRAN ELECTRONICS & DEFENSE	TECHNATIUM	
SAFRAN REOSC	TECHNIP ENERGIES	
SAFT	TELEDYNE E2V SEMICONDUCTORS	
SAP SOCIETE AUDOISE DE PRECISION	TELERAD	
SAPIENZA CONSULTING	TELESPAZIO	
SAT CONSULT	TEMISTH	
SATCONSEIL	TERAKALIS	
SCALAGENT		

257 FRENCH SPACE ENTREPRISES

→ <https://cnes.fr/en/entreprises/catalogue-industrie-spatiale>

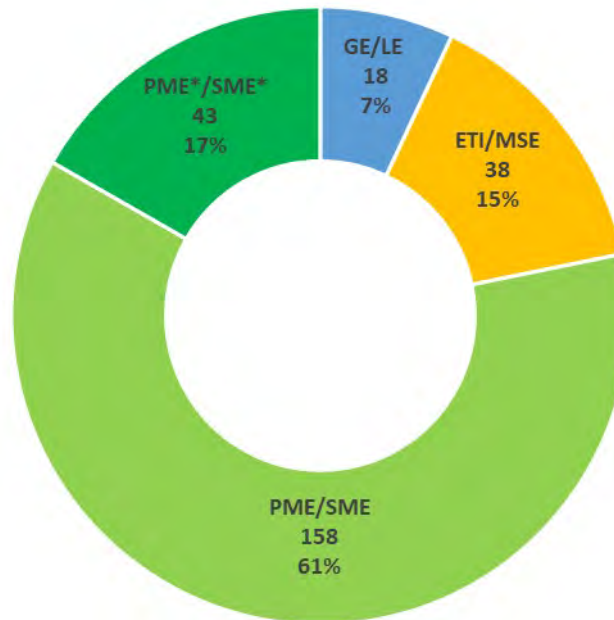

	Type	Staff headcount	Turnover	Total balance sheet
PME / SME	Petite et Moyenne Entreprise Small and Medium Enterprise	≤ 250	≤ 50 M€	≤ 43 M€
PME* / SME*	Petite et Moyenne Entreprise étendue Extended Small and Medium Enterprise	Same criteria as SME regardless of shareholding		
ETI / MSE	Entreprise de taille Intermédiaire Mid-sized Enterprise	≤ 5000	≤ 1500 M€	≤ 2000 M€
GE / LE	Grande Entreprise Large Enterprise	5000 <	1500 M€ <	2000 M€ <

1997 COMPETENCIES

WITH AN ON-LINE SOURCING TOOL

→ <https://cnes.fr/en/entreprises/catalogue-industrie-spatiale>

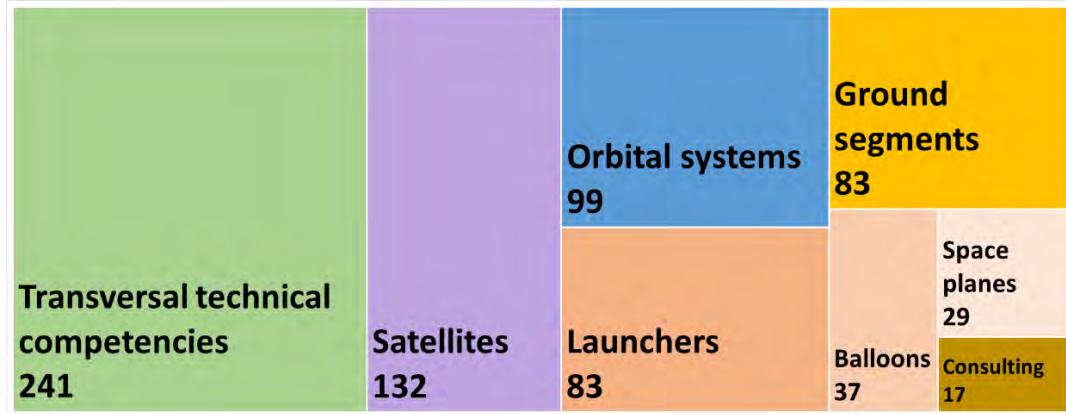

Competency domains

Orbital systems	Orbital systems prime contractor Orbital systems engineering On-board to ground engineering	Orbital systems equipment manufacturers AIT-AIV System simulation means
Ground segments	Ground control center Ground mission center Ground segments equipment	Ground station Beacon, user terminal Orbital system operations
Launchers	Launcher prime contractors Launcher engineering Launcher Propulsion Launcher equipment	Launcher test means Launch base development Launch base exploitation Launch services and operations
Satellites	Structure Thermal control Harness Electrical power Propulsion Avionic Com payload TTC	AOCS On-board computer Telemetry payload Scientific payload Optical payload Microgravity payload Navigation-Localisation payload Security-defence payload
Space Planes	Space plane prime contractors Space plane engineering On-board to ground engineering Space plane equipment	Space plane test means Aerospace base development Space planes services and operations
Balloons	Balloon envelopes Balloon gondola & on-board equipment	Balloon miscellaneous (SW, ground segment, metrology, parachute, etc.)
Transversal competencies	System engineering AIV AIT Test means Flight dynamics Atmospheric re-entry Space data processing Security, encryption Mechanisms Structure Mechanics Aerothermodynamics Electric Thermic, coatings, MLI, thermoelectronics, cryotechnics, etc. Electronic components	Electronics Antennas Robotics Electromagnetic compatibility Radiofrequencies Satellite location Time-Frequency Industrial gases Pyrotechnics Quality Assurance (product assurance, safety) Materials & Process Coatings Space environment effects
Consulting in space domain	Concept, feasibility and engineering studies of space systems Assistance in setting-up projects and contracts Assistance to projects and contracts follow-up	Support and training to operations and exploitations of space systems

FRENCH SPACE INDUSTRY CAPABILITIES CATALOGUE

Page intentionally left blank

Transversal competencies



3D PLUS is the world-leading supplier of advanced high-density radiation tolerant components miniaturized with our unique 3D vertical interconnect technology. With more than 200,000 modules in space, and more than 25 years of flight heritage with no reported failure, we provide the global space industry for all types of applications: telecommunications, Earth observation, navigation, launch and manned space vehicles, science missions and constellations.

COMPETENCIES & CAPABILITIES

- Development of advanced high density 3D package and die stacking technology that allow gaining a factor of at least 10 on the weight and volume of the components comparing to other existing 2D traditional solutions.
- Design of Analog and Digital Space Radiation Hardened electronics utilizing the Radiation Intelligent product's concept.
- Manufacturing of Standard Products and custom System-in-Package for space applications.
- ESA and CNES approved capability domain and manufacturing line.
- Production of 30,000 space qualified modules per year in our facility located nearby Paris.



3D PLUS

PRODUCTS & SERVICES

3D PLUS offers a wide range of catalog radiation tolerant products including Memory and IP cores, Computer Cores, Interfaces, POL converters, Peripherals and Radiation Protection ICs and Camera heads. Custom System-In-Package (SiP) solutions are also available for our customers who want to shrink their design thanks to our State-of-the Art stacking technology and recognized design, manufacturing and test expertise.

3D PLUS products bring key advantages for our customers' electronic designs:

- High performance / high density / very high speed
- High reliability / Rugged to extremely harsh environments and Space radiations
- Extreme miniaturization / very small factor
- Space qualification and very large flight heritage.
- Long term availability

MAJOR SPACE PROJECTS & REFERENCES

Our Flight Heritage is expanding continuously with products launched in Space every month in GEO, MEO and LEO orbits, for deep space exploration missions, for satellite constellation fleets, and for governmental missions.

Our Flagship missions include Mars 2020, Mars Science Laboratory, Rosetta, Chandrayaan-3, New Horizons, LiciaCube (DART), Juno, OneWeb, AlphaSat, Sentinel, Ariane 5, ISS, Parker Solar Probe, Insight, and many more.

POINT OF CONTACT

ADDRESS 408 rue Hélène Boucher
78530 BUC - France

WEBSITE www.3d-plus.com

PHONE +33 (0)1 30 83 26 50

POINT-OF-CONTACT: Pierre-Eric BERTHET
+33 (0)6 07 01 12 23

TURNOVER 75 M€

WORK FORCE 350

SPACE TURNOVER 75 M€

R&D Represents 17% of Turnover.

Satellites
Transversal competencies



For the past 15 years, we have been working on the development of SLA technology to make ceramic parts printable in 3D. We have developed the technology and tested its reliability with major industrial partners.

3DCeram has entered the final maturation stage, the industrialization phase thanks to its manufacturing process.

COMPETENCIES & CAPABILITIES

- As a process provider for 3Dprinting, we have developed an offer from printing to sintering ceramics with programs and equipment for the whole process:
- Software suite selected to optimize the possibilities offered by ceramic 3D printing.
- Cleaning hood specifications and installation plan. Kiln and refractory supports (optional).
- Co-Engineering & assistance qualifying key aspects of the specifications (performance, costs and time line)



A range of 3D printers for ceramics



CERAMIX
For labs & research centers

CERAMIX PLUS
From lab to fab

CERAMIX ULTIMATE
For mass production



An extended range of technical ceramics



3DCERAM

PRODUCTS & SERVICES

3DCeram is an additive manufacturing process provider with a strong innovation culture:

- An extended range of 4 printers, including an hybrid 3DPrinter with building platform ranging from 100x100 to 600x600mm
- A portfolio of 15 technical ceramics mix (Si_3N_4 , AlN, ...). On-demand service to develop customized ceramic material for our customer
- Aftersales services and maintenance packs and training offer to stand by our clients.
- **3D-AIM:** Customized support as well as advices for the companies which consider the AM technology in ceramic like a potential solution for their products.

MAJOR SPACE PROJECTS & REFERENCES

Customers:

- CNES
- ESA
- SAFRAN Group
- THALES Group
- AIRBUS GROUP

POINT OF CONTACT

ADDRESS 27 rue de Petit Theil
Limoges France

WEBSITE www.3dceram.com

PHONE +33 (0)5 55 04 10 90

POINT-OF-CONTACT : Christophe, CHAPUT, CEO,
christophe.chaput@3dceram.com, +33 (0)5 55 38 11 45

TURNOVER 5 M€

WORK FORCE 30

SPACE TURNOVER 0.5 M€

SPACE WORK FORCE 10

Orbital systems
Transversal competencies



ABBIA is a French limited SME created in 2006 in Toulouse by a private investor.

ABBIA is specialised in GNSS signals processing and GNSS data analysis.

Since 2006 our Engineering Team is implicated in the main European GNSS programs (EGNOS and Galileo) in close collaboration with the major actors of the European GNSS marketplace.

COMPETENCIES & CAPABILITIES

The company is highly specialized in:

- GNSS signals processing,
- GNSS innovative algorithms creation,
- GNSS software design and development,
- GNSS research and development activities.

ABBIA also provides consultancies to GNSS space agencies, SBAS operator or major industry actors seeking for highly specialized GNSS competencies.

- OASIS SOFTWARE TOOL BOX -

We have developed a set of Software tools that allow us to answer to daily customer needs. OASIS suite products, is a software toolbox allowing to perform different analyses on the information, prediction, propagation models covering a wide range of GNSS topics and in particular for EGNOS/SBAS.



OASIS MON
EPNOC SBAS Versatile Performance Monitoring including analyses at satellite and ionosphere levels

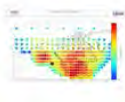

OASIS USR
User position solution estimation from receiver raw measurements applying GPS-only or EPNOC SBAS solutions

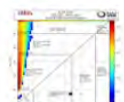

OASIS REC
Analysis of received signal quality performance in terms of Signal to Noise Ratio and measurement code & phase noise for different carrier frequencies

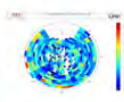

OASIS SCINT
IONOS ionospheric monitoring in amplitude and phase based on ionospheric characterization as well as impact on the SBAS receiver performance in terms of Loss Of Lock, Cycle Slip and Noise

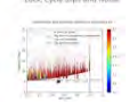

ABBIA “GNSS Technologies”

PRODUCTS & SERVICES

ABBIA is one of the companies involved in the EGNOS programs. ABBIA staff have been providing consultancies on different areas for EGNOS AOC and V2:

- Algorithms and Performances of the CPF,
- AIV-IVQ (Integration/Validation and Qualification),
- GNSS AIV platforms and test benches management,
- System Software Maintenance and Operations training,
- System Engineering and Software Tools for System Qualification,
- Sub-contractor’s management and different system evolutions studies.

In the frame of EGNOS V3, ABBIA has been awarded the Dual Frequency Multi Constellation (DFMC) software toolbox for EGNOS V3 System Performances qualification.

In the frame of Galileo Ground Mission segment, ABBIA have been involved in the IVQ and Software Maintenance activities. ABBIA has been awarded the GMS Local Maintenance Equipment (LME).

MAJOR SPACE PROJECTS & REFERENCES

ABBIA has been involved in EGNOS AOC, EGNOS V2, EGNOS V3 phases C/D.

ABBIA has been involved in the Galileo GMS phase C/D.

ABBIA has been part of the MAGNIFIC-H2020 Project awarded by the GSA.

ABBIA has provided consultancies to ESA EGNOS Project Office, IRT Saint-Exupéry, ESSP SAS, CNES.

POINT OF CONTACT

ADDRESS 27, rue Jules Amilhau

31100 Toulouse France

WEBSITE <https://www.abbia-gnss.com>

PHONE +33 (0)5 34 61 25 44

POINT-OF-CONTACT : Mr EKAMBI Bertrand – CEO

TURNOVER 0,8 M€

WORK FORCE 10 employees

SPACE TURNOVER 0,8 M€

Satellites
Transversal competencies



Absolut Sensing is a young company based in Toulouse. Our vision is to monitor, understand and predict climate change. Our mission is to minimize global pollution through our GESat project by developing a constellation of satellites capable of accurately measuring industrial methane emissions. Thanks to our constellation, we provide near real-time, high precision space imagery data & analytics solutions. We support government agencies and industrial corporations in their need to collect precise CH₄ emission information by satellite, drone, or aircraft for accelerating the advent of a low-methane industrial base.

COMPETENCIES & CAPABILITIES

Thanks to a disruptive technological advance in miniaturized cryogenic hyperspectral space-borne instrumentation, Absolut Sensing will allow measurements with unique precision of methane emissions.

We are using a compact optical design, fast processing electronics and the following three key technological innovations that can reach unique precisions:

- Exclusive linearly variable filter for high resolution hyperspectral imaging
- Absolut System's miniaturized cryogenic cooler
- A state-of-the-art high-speed avalanche HgCdTe detector

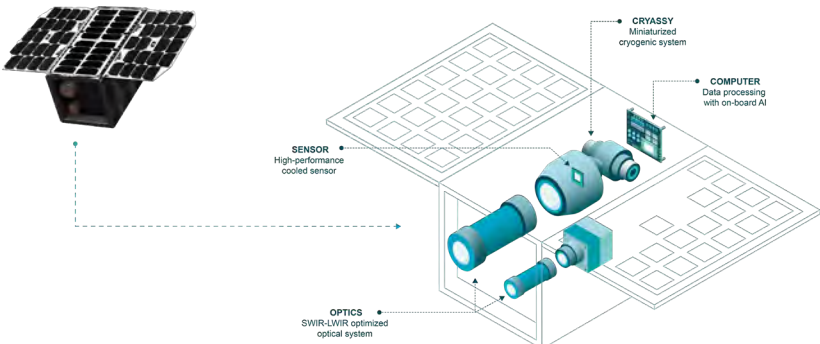

ABSOLUT SENSING

PRODUCTS & SERVICES

Absolut Sensing develops technologies to monitor, understand and predict global changes.

For this, we are redefining miniaturized remote sensing systems integrated with Smallsats platforms to provide planetary intelligence services. The GESat constellation is Absolut Sensing's flagship program, designed to provide daily measurements of methane emissions plumes. It is based on a constellation of micro-satellites incorporating a miniaturized imaging spectrometer, based on an innovative dispersive design with a high spectral resolution.

In order to accelerate the energy transition, we ensure the monitoring of our planet and enable major scientific advances, working with both institutional players and large organizations.

Our expertise and our ability to innovate enable us to design and propose effective solutions adapted to the needs of our clients, particularly in the field of energy transition.

MAJOR SPACE PROJECTS & REFERENCES

1) Environmental intelligence

We are developing remote sensing instruments to measure greenhouse gas emissions (methane, CO₂) on local, regional, and global scales to support emitting companies and regulators through the GESat project.

2) Geo intelligence

Thanks to our expertise in miniaturized hyperspectral instrumentation and associated data processing chain, we support government agencies in their need to collect information by satellite, drone, or aircraft.

Absolut Sensing is supported by the ESA BIC & Gate 1 – and currently under contract with ESA and Total Energies, as well as CNES.

POINT OF CONTACT

ADDRESS 34 Boulevard de la Méditerranée 31000 Toulouse, France

WEBSITE www.absolut-sensing.com

PHONE +33 (0)7 88 31 12 09

POINT-OF-CONTACT : Laurent, Tristan, Chief Executive Officer

tristan@absolut-sensing.com

+33 (0)7 88 31 12 09

TURNOVER

WORK FORCE 10 employees

SPACE TURNOVER

SPACE WORK FORCE 10 employees

Orbital systems
 Satellites
 Launchers
 Transversal competencies



ABSOLUT SYSTEM (AS) is a technology enabling company offering its high skills in to provide customs-made cryogenic and thermal equipment. Absolut System design, optimize, test and qualify innovative solutions from components as per cryocooler, heat exchangers or thermal links, up to integrated system as per vacuum test chamber or infrared camera.

AS benefits through its width field of activity (industry, laboratories, research programs, aeronautics and space) of a large crossed linked between activities and is thus able to offer its customer the best technological choice with the highest quality and the flexibility offered by an SME.

COMPETENCIES & CAPABILITIES

- Development, realization and tests of cryogenic sub-systems for payloads: space cryocooler, cryogenic thermal links (copper, pure aluminium or POG), cryostat, cryogenic assembly, cryogenic fan
- Development, realization and tests of equipment for payload thermal management: centrifugal pump/fan, efficient and compact heat exchangers
- Design, realization and set-up of vacuum test bench for in-space propulsion large electrical thrusters
- Thermal tests (cycling) in vacuum environment down to $-250\text{ }^{\circ}\text{C}$
- Zero or Reduced boil-off systems for cryogenic long term storage for LH2, LCH4, LOX, Liqui Argon
- Analysis of cryogenic propellant behavior in low gravity

Space cryocoolers: Pulse tube, turbo-brayton...)



HiRel turbomachines

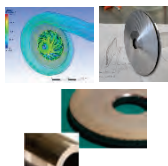

High performance cryogenic thermal links



CFD modelling



Cryogenic test chambers



ABSOLUT SYSTEM

PRODUCTS & SERVICES

Low cost cryogenic assembly for earth observation

Space cryocoolers for earth observation:

- Low-cost Pulse-Tube LPT6510 (with our partner Thales Cryogenics)
- Vibration-free turbo-Brayton (on-going development, TRL 4)

Cryogenic equipment:

- Cryogenics thermal links: copper, alu or POG
- Cryogenic fan for cryogenic thermal management

On-ground large vacuum test chamber

On-demand cryogenic equipment

Thermal management: efficient and compact heat exchangers, centrifugal pump/fan

MAJOR SPACE PROJECTS & REFERENCES

- More than 15 cryogenic thermal links Flight Models for different observation programs in 2018/2019: MTG, IASI-NG, EUCLID, Metimage
- Heat Exchangers Flight Models in 2019 for the Mechanical Pump Loop developed by Thales Alenia Space for very large GEO telecom satellites
- Design, realization and set-up of large capacities vacuum test bench for large in-space propulsion electrical thruster
- Different R&T projects with CNES and ESA on cryogenic equipment/concepts for launcher propulsion and for payloads

Main customers (alphabetic order): Airbus Defence and Space, CNES, ESA, MT Aerospace, Safran, Thales Alenia Space

POINT OF CONTACT

ADDRESS ABSOLUT SYSTEM
2 rue des murailles 38170 Seyssinet-Pariset - France

WEBSITE www.absolut-system.com

PHONE +33 (0)4 56 40 86 47

POINT-OF-CONTACT : TROLLIER Thierry, Technical Manager
thierry.trollier@absolut-system.com +33 (0)6 59 29 04 86

TURNOVER 3 M€

WORK FORCE 16

SPACE TURNOVER 1.5 M€

SPACE WORK FORCE 7

Satellites
Ground segments
Transversal competencies



ACRI-ST is specialized in the field of space remote sensing for Earth and Space Observation. Its main activities are the collection, archiving, quality control, calibration/validation, processing, analysis and distribution of mass data transmitted by satellites, to improve knowledge of how our planet and universe work for sustainable development and to democratize and share this knowledge.

Our team of more than 90 engineer-researchers work with the whole chain of satellite data. We develop and operate valuable space data services for the space industry, scientists, space agencies and public decision-makers, an essential activity in this era of climate change.

COMPETENCIES & CAPABILITIES

- Satellite Remote Sensing (RS) Earth Observation (EO) Systems
 - R&D in satellite RS applied to environmental issues
 - Engineering for EO mission/instrument specifications
 - Development of Algorithms & Data Processor Validation
- Ground-Segment Operations Systems, Collaborative Exploitation Platform; Mission Performance Centre for all Optical Copernicus Missions (OPT-MPC), Processing Center, Ground Station
- Studies and research on Sciences of the Universe and Astrophysics
- Climate Change & Environmental Monitoring, Forecast & Surveillance
- Development of Decision-Making Tools & Solutions through its operational bodies ARGANS, adwäisEO, ARCTUS and ALBAVALOR
- ICT/Big Data
 - R&D for EO mission Ground Segments & Environmental Engineering
 - High Performance Computing, Data analytics through its subsidiary adwäisEO
- Control and reception operations for Nanosatellite (UHF / VHF bands)
 - R&D
 - Innovation & Incubators
 - Ground Segment as a Service

PRODUCTS & SERVICES

- C-TEP: platform to manage & process EO data for users
- GlobColour (<https://hermes.acri.fr/>)
- Crowdsourcing and satellite data (SCOLive, Jelly fish App) (Contact: scolive@acri-st.fr)
- Satellite data control & receiving stations in ACRI-ST CERGA (Grasse) (Contact: contact@astralink.eu)
- Space observatory in ACRI-ST CERGA (Grasse) (Contact: acristellar@acri-st.fr)
-

Combined highly configurable mobile application and web interface to fuse participative reporting (crowdsourcing) and environmental data (mainly from Copernicus). Powerful decision-making tool.

ACRI-ST

MAJOR SPACE PROJECTS & REFERENCES

Cal/Val

- OPT-MPC Mission Performance of Copernicus optical missions (EU/ESA contract – 2021 - present)
- Towards Copernicus Cal/Val Solution - C CVS (H2020 project) (2021 – 2022)
- Ground-Based Observations for Validations of Copernicus Land service products (GBOV) (EU/JRC contract 2017 – Present)
- Ground-Based Observations for Validation of 3 Sentinel-3 datasets (Water Vapour, Aerosol Optical Thickness and Land Surface Temperature) (LAW) (ESA contract 2020 – 2022)

New sensors

- CO2M & CHIME simulators (EU/ESA/OHB/TAS contracts – 2021 – present)
- Enhanced super-spectral (from VIS to MIR) EO payload demonstrator (SURPRISE, H2020 project – 2020 – present)

Data processing/archiving/distribution

- Sentinels Archiving Center (ALTA) (EU/ESA contract – 2020 – present)
- Earth Observation Data Archiving & Processing Service (DAMPS) (ESA Contract – 2021 – present)
- Sentinel 3 production service (EU/ESA Contract 2021 – present)
- Sentinel 2 reprocessing service (EU/ESA Contract 2022 – present)
- Ground Segment Engineering Services (GSES) (EUMETSAT Contract 2016 – 2020)
- On demand processing CDSE (EU/ESA/T-System/CloudFerro Contract 2022 – present)
- Marine Data store (EU/Mercator/lobelia contract 022 – present)

Software/processors

- Prototypes & operational processors (IPFs) (MERIS, GOMOS, SMOS)
- Sentinel-3 (OLCI, SLSTR, MWR, SRAL) IPFs
- A processor for Fiducial Reference Measurements for Ocean Colour FRM4SOC (EUMETSAT/U. Tartu contract – 2021 – present)
- LSTM level 2 (ESA contract – 2023 – present)
- CHIME level 2 (ESA/DLR contract – 2023 – present)

New Space

- Data reception and distribution (UVSQSAT & INSPIRE SAT7 – Latmos 2021 – present)

Astrophysics

- Machine learning tools for planetary sciences: development, EOSC integration, and portal for Europlanet Research Infrastructure 2024
- Spectro-imaging tools for data fusion: James Webb Space Telescope, Sentinel 2 and 3 missions (INCLASS - ANR Labcom with IAS)
- Explore Platform develops 6 Scientific Data Applications in Stellar, Galactic and Lunar science (H2020 project, 2021 – present)

Oceanography

- Ocean Strategic Services (OSS) project beyond 2015, awarded the Etoile de l'Europe prize
- Copernicus Marine Services (EU/Mercator/CNR – 2018 – present)
- Eurosea (EU/H2020 2019 – present)
- OPFish indicators (EU/JRC 2022-2023)

POINT OF CONTACT

ADDRESS 260 route du Pin Montard BP 234
F-06904 - Sophia Antipolis - France

WEBSITE www.acri-st.fr

PHONE +33 (0)4.92.96.75.00

POINT-OF-CONTACT communication@acri-st.fr

TURNOVER 32M€

WORK FORCE 170

SPACE WORK FORCE 150

Orbital systems
 Satellites
 Ground segments
 Launchers
 Transversal competencies



ACTIA Aerospace is the new entity of ACTIA, a French, international and family-owned group.

ACTIA Aerospace has a long-term expertise in aeronautics (producing 6,000 flight computers yearly), more than 50 years in SATCOM, and became a key player in New Space.

The “Embedded systems” Division of ACTIA Aerospace, supports its customers with its development, industrialization and mass production expertise of embedded electronics.

COMPETENCIES & CAPABILITIES

ACTIA has been designing, integrating and maintaining its own electronic equipment for over 30 years. To help you tackle the challenges ahead right now, we use our experience and know-how to address your needs and provide you with the widest offering of Design, Manufacturing and Services:

- Automated assembly lines: from low to high production runs
- First European EMS accredited NADCAP in 2008
- 220M€/year electronic components procurement
- 18 months NewSpace mass production readiness feedback
- 4500+ avionics critical equipment produced each year



ACTIA Aerospace - TOULOUSE

PRODUCTS & SERVICES

ACTIA assists system and equipment manufacturers in the search for innovation and competitiveness from design to manufacturing & tests:

- R&D, Design
- Qualification
- Industrialization (DFx, test benches development)
- Production (PCBA, tests, integration)
- Burn-in & tests
- Supply chain
- Strategic components storage
- Obsolescence management

In addition, ACTIA is able to offer on-the-shelf equipment for payloads & platforms like GNSS Receiver, SSPA or OBC (with partner).

MAJOR SPACE PROJECTS & REFERENCES

Main space projects:

- Detailed design, Industrialization and mass production of more than 1400 units (BMS and PPU) for **Oneweb** and following constellations.
- Industrialization of PPU, PCDU, OBP and OBC for constellations
- Development of GNSS receiver and SSPA with CNES Support

Main customers:

- AIRBUS Defense & Space
- AIRBUS ONEWEB Satellites
- THALES Alenia Space
- CNES
- KINEIS
- EXOTRAIL

POINT OF CONTACT

ADDRESS 5 rue Jorge Semprun
B.P. 74215 - 31432 TOULOUSE cedex 4 (FRANCE)

WEBSITE aerospace.actia.com

PHONE +33 (0) 5 61 17 61 61

POINT-OF-CONTACT : Alexandre LACHAISE, CCO
alexandre.lachaise@actia.fr, +33 (0) 6 98 57 92 12

TURNOVER 50 M€

WORK FORCE 30

SPACE TURNOVER 3 M€

SPACE WORK FORCE 20

Ground segments
Transversal competencies



ACTIA Aerospace is the new entity of ACTIA, a French, international and family-owned group.

ACTIA Aerospace has a long-term expertise in aeronautics (producing more than more than 6,000 flight computers yearly), more than 50 years in SATCOM, and became a key player in New Space.

The Satcom Division of ACTIA Aerospace, provides customized solutions for satellite telecommunications (ground segment).

COMPETENCIES & CAPABILITIES

For almost 50 years, ACTIA Telecom's offer in the Satcom Defense and Civil field includes supplying systems for the ground segment of satellite transmissions (power amplifiers, integration assemblies, supervision systems, etc.), supplying turnkey stations (stationary, transportable, tactical and mobile terminals) and providing the related services: engineering, installation and implementation, training, maintenance in working condition.

ACTIA Telecom brings the following key benefits to its clients:

Sector experts: land, maritime, air and space

Dedicated industrial site for Satcom: R&D, manufacturing, integration, qualification capabilities and customer service

Extensive records in satcom ground segment integration

Expertise in designing / manufacturing of high-power amplifiers (TWTA, SSPA) and earth stations up to Q/V band

Services: customized trainings for operation and maintenance, antenna commissioning (up to 13m), Integrated Logistic Support.



ACTIA Aerospace - Dinard

PRODUCTS & SERVICES

ACTIA Telecom offers a wide range of robust and easy-to-use satcom terminals and systems guaranteeing secure 2-way transmissions of video, voice & data in C, Ku, X, Ka and Q/V Band and dual band (X/Ka). Compatible with all major modems.

- TravelSat: compact manpack terminal
- FlyAwaySat: easily transportable terminal
- MobileSat: low profile, light weight On-the-Move terminal
- CoreSat : earth station with 1m to 9m antennas with manual or automatic pointing.
- ACTIA Satcom network monitoring system which offers operators simple and effective means of monitoring and controlling a satcom ground segment and its network of terminals.

ACTIA Telecom also provides its customers with all the support they need in the design and acquisition phase and during operation: engineering, training, hotline and maintenance.

MAJOR SPACE PROJECTS & REFERENCES

ACTIA Telecom is involved in commercial, governmental and defense programs, providing high power amplifiers, satcom terminals, network monitoring systems and/or full ground satcom segments such as

- COMCEPT (Athena Fidus),
- Syracuse III and IV, Eutelsat KONNECT, ESA Rosetta mission, ESA Copernicus
- TEBA 1 (Egypt), SGDC (Brazil), Yahsat
- ASNMC (NATO)
- CESARS, Satcom On the Move (CNES)

POINT OF CONTACT

ADDRESS 2 rue Amiral Bérenger
35801 Dinard, France

WEBSITE <https://satcom.actia.com/>

PHONE +33 (0) 2 99 46 24 75

POINT-OF-CONTACT : Boudet, Henri, Sales Manager Satcom
henri.boudet@actiatelecom.fr , +33 (0) 6 88 94 94 94

TURNOVER 50 M€ for the Satcom division

WORK FORCE 120 (Satcom division)

SPACE TURNOVER 30 M€

SPACE WORK FORCE 120

Orbital systems
 Launchers
 Satellites
 Transversal competencies



AD Industries is a group of 1500 employees with 4 centres of expertise:

- Mechanics
- Composites
- Sheet metalwork
- Hydraulics

ADI Composites, ADI Mechanical assemblies & ADI Tubes are involved in Space activities since more than 15 years with qualified processes.

COMPETENCIES & CAPABILITIES

Lightness and stabilities are major properties required from materials used in space structures. High performance composites material successfully meets these standards providing the best technical and economical trade-off.

High Modules carbon fibre material is used combined with epoxy or cyanate ester type resins with certified processes. Assembly and bonding processes are developed by our engineering teams and are subject to a qualification with the final customers.

Our main means

- 8 autoclaves, ovens, presses
- Large CNC machining equipment for composite and metallic materials
- Tube bending equipments

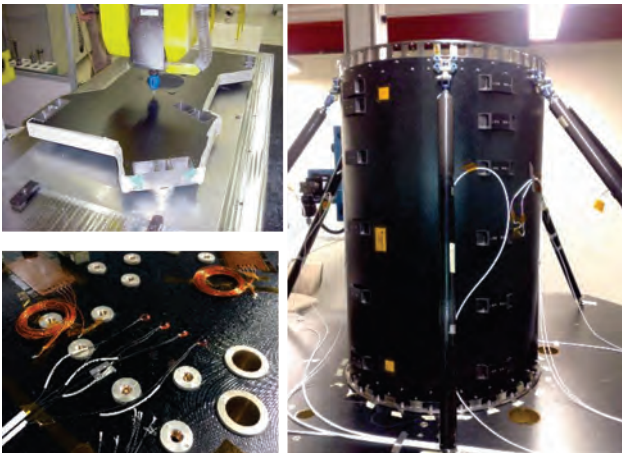

AD INDUSTRIES

PRODUCTS & SERVICES

High Performance Composite / ADI composites

- Carbon antenna support structures
- Carbon tubes & beams for antennas
- Carbon rods with titanium and fittings
- Instrument support panels
- Battery structure with metallic heat pipes (Aluminium or composite sandwich)
- Launch vehicle structural parts

Mechanical assemblies / ADI Mechanical assemblies

- Medium to large machining capabilities up to 6000 mm (Aluminium & Titanium)

Tubes / ADI Tubes

- Range of processed tubes Ø 1 mm to Ø 150 mm

MAJOR SPACE PROJECTS & REFERENCES

Non exhaustive list for applications for Airbus Defence & Space, Thales Alenia Space, Air Liquide, Ruag Space, Sonaca, EHP, Ariane Group.

Yahsat
AM22
Rascom
Goci
CSO
Iridium
Ariane 5 et 6
.....

POINT OF CONTACT

ADDRESS Headquarter La Chassagne – Zac du Mazaud
19100 Brive France

WEBSITE <https://www.ad-industries.fr/>

PHONE +33 6 73 19 08 23

POINT-OF-CONTACT: Sandrine Lasserre – Businnes Dev Manager
Sandrine.lasserre@ad-industries.fr

TURNOVER 210 M€

WORK FORCE 1500 employees

SPACE TURNOVER 2M€

Orbital systems
Satellites
Transversal competencies



AddUp, a joint venture created by Michelin and Fives, is a global metal additive manufacturing OEM offering multi-technology production systems, including the FormUp® range of robust and open-architecture Powder Bed Fusion (PBF) machines, as well as the BeAM Modulo and Magic lines of industrial Directed Energy Deposition (DED) machines.

COMPETENCIES & CAPABILITIES

Additive manufacturing offers clear benefits to the aerospace industry including improved design, reduced weight via topological optimization, enhanced performance, and more efficient production processes. Aerospace components often require intricate and complex shapes that are difficult or impossible to achieve using traditional manufacturing methods. AM allows the creation of highly intricate structures, such as generative designs for lightweighting, that can optimize aerodynamics and thermal management.

The defense sector can face supply chain disruptions due to geopolitical issues or emergencies. AM reduces lead times by eliminating the need for some tooling and enabling on-demand production. AM also offers the unique ability to produce critical components on-site or near the point of use, reducing dependence on external suppliers.

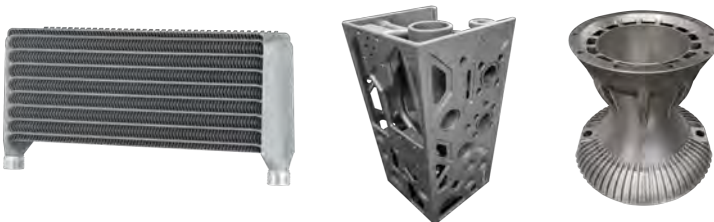

AddUp

PRODUCTS & SERVICES

AddUp's FormUp 350 PBF range is modular and scalable to provide the highest productivity while ensuring user safety. The DED machines are designed for industrial production and equipped with in-house designed and developed nozzles to provide maximum precision and very high productivity. To provide customers with a true Industry 4.0 solution, AddUp also provides a complete monitoring solution providing quality assurances after each and every build.

In addition to the machine design and manufacturing, the AddUp group also offers part production, POC production, metal AM consulting services, AM training, and design for AM, making AddUp your one-stop for metal AM.

MAJOR SPACE PROJECTS & REFERENCES

<https://addupsolutions.com/industries/aerospace-and-defense/>

POINT OF CONTACT

ADDRESS AddUp SAS 13-33 Rue Verte ZI de Ladoux, 63118 Cébazat France

WEBSITE www.addupsolutions.com

PHONE +33 (0)4 73 15 25 00

POINT-OF-CONTACT : contact@addupsolutions.com

TURNOVER NC

WORK FORCE 150 employees

Orbital systems
Satellites
Transversal competencies



AdvEOTec is specialised in test and measurement of optoelectronic devices.

COMPETENCIES & CAPABILITIES

AdvEOTec's test house services range from the evaluation to the qualification of optical, electronic, optoelectronic, and RF/Microwave devices.

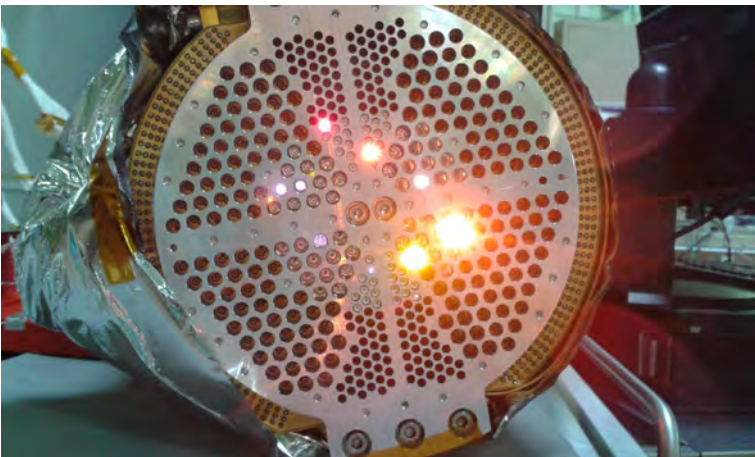

AdvEOTec

PRODUCTS & SERVICES

AdvEOTec's Lab is equipped of:

- Climatic chambers from -70°C to 300°C
- Thermal Vacuum chambers from -40°C to 125°C below 10⁻⁵ mbar
- Mechanical Shaker 3kN
- Highly-Collimated Solar Simulator AM0
- ISO5 and ESD safe Environment
- Measurement Benches for optical emitters, receivers and guided optics.

MAJOR SPACE PROJECTS & REFERENCES

AdvEOTec was in charge of screening and qualification of optoelectronics parts for Missions: CHEMCAM, PHARAO, GAIA, EUCLID, GALILEO, DECLIC-EVO, MICROCARB, IASI-NG, SUPERCAM, TARANIS.

POINT OF CONTACT

ADDRESS 6 rue Jean Mermoz, ZA Saint Guénault
91080 EVRY-COURCOURONNES France

WEBSITE www.adveotec.com

PHONE +33 (0)1 60 86 43 61

POINT-OF-CONTACT : LHUILLIER, Sébastien, Business Engineer
salesdpt@adveotec.com, 01 60 86 43 61

TURNOVER 0.9 M€

WORK FORCE 10 employees

SPACE TURNOVER 0.7 M€

SPACE WORK FORCE 8 employees

- Orbital systems
- Launchers
- Satellites
- Ground segments
- Balloons
- Transversal competencies



Located between Nantes and Saint Nazaire, at the heart of Pays de la Loire space and aeronautical industries. AFC-STAB is an expert in manufacturing tools for forming or molding and the production of complex composite parts and sets.

With years of experience, AFC-STAB carries out all your project and brings you new solutions with all its innovative products

«Customer satisfaction and proactivity are our key features»

COMPETENCIES & CAPABILITIES

- Molds conception and design from CAO part
- Production of 2m in diameter molds with a RMS less than 50 microns for composite part.
- Production of heating molds for the curing of thick composites parts.
- Machining of several materials (composite, aluminum, epoxy board, ...)
- 3 manufacturing devices with 5 axes machining up to 6m in length, 4m wind, Z: 2000mm
- Production of composite parts up to 180°C



In production and finished self-heating mold for CNES



AFC-STAB

PRODUCTS & SERVICES

AFC-STAB offer a wide range of services:

- Expertise: Our Engineering and Technical Department advises you, studies the feasibility of your project and proposes suggests technical solutions.
- Project management:
 - We assist you from the prototype to the final product and we adapt to your request.
 - Our experience allows us to respond to your request by being driving force in your project.
- Implementation:
 - Respect of your specifications and controlled lead time

And numerous innovative products with our STAB patented material:

- Aéro-STAB: Low density, low CTE and high temperature resistance for forming tools and prototyping
- Usi-STAB: Aero-STAB with carbon coating for series production
- Auto-STAB: Self-heating mold up to 200°C

MAJOR SPACE PROJECTS & REFERENCES

- Patent filed in collaboration with CNES for our Auto-STAB product
- Manufacturing of a several satellite dish molds for Thales Alenia Space including:
 - 4m in diameter self-heating molds for backing parts
 - 2.2m in diameter self-heating molds with a RMS of 42 microns for satellite dish
 - Several non-heating molds ranging from 0.7m to 2m in diameter
- Manufacturing of land-based reflector mold for Ineo

POINT OF CONTACT

ADDRESS 10 rue Louis Bréguet – P.A. du Pont Béranger
44680 Saint-Hilaire-de-Chaléons - France

WEBSITE www.afc-stab.com

PHONE +33 (0)2.28.25.09.27- 06.08.34.82.62

POINT-OF-CONTACT : NAYLOR, Robin, R&D Manager

robin.naylor@afc-stab.com, +33(0)2.28.25.91.53

TURNOVER 0.7 M€

WORK FORCE 6 employees

SPACE TURNOVER 0.2 M€

SPACE WORK FORCE 6 employees

- Orbital systems
- Space planes
- Satellites
- Ground segments
- Transversal competencies



AGENIUM Space offers expertise in the fields of Earth Observation and Deep Learning in two areas: space missions and multisource downstream services (satellite data, UAV, IoT...). In space missions, its skills cover as much on-board processing as image ground segments and spaceflight dynamics. AGENIUM Space develops innovative solutions for deep learning on the edge and particularly on-board satellites. AGENIUM Space team has a large experience in projects for the key accounts of the European spatial sector: CNES, ESA, EC, EUM, Airbus, Thales, ...

COMPETENCIES & CAPABILITIES

DEEP LEARNING:

On board processing, Object detection and identification (airplanes, ships, buildings, clouds...), Land cover/land use, change and anomalies detection, Future ground segments (resampling, radiometric and geometric corrections...), Emulation and models' inversion (atmosphere, biophysical parameters, waveforms...), 3D reconstruction, Predictive maintenance, Analytics, Decision optimization

SATELLITE IMAGES PROCESSING AND ANALYSIS

Radiometric corrections, Calibration, Geometrical corrections, Image Quality, Straylight detection and correction, Definition of optical and infrared missions, Image simulation, In-flight commissioning, Information extraction, Classification, Segmentation, Multi-temporal and multisource series analysis

ON GROUND

ON BOARD

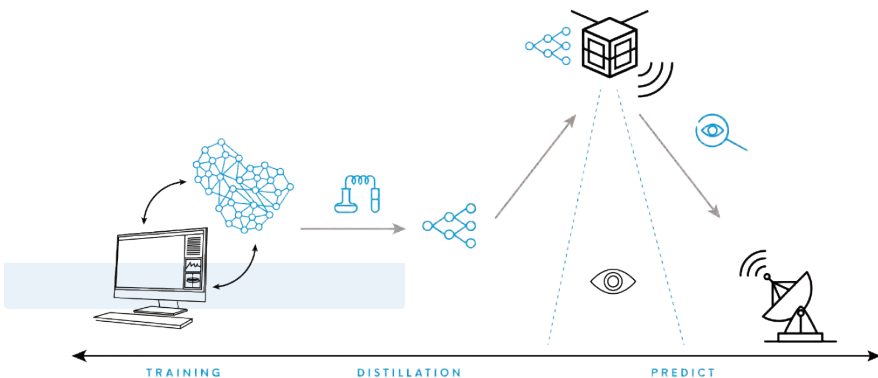

AGENIUM SPACE

PRODUCTS & SERVICES

AGENIUM Space team masters all phases of space projects and the preparation of operational services:

Space projects:

- Feasibility and design studies, contribution to the definition of space missions
- Image chains prototyping
- Development of scientific ground segments
- Support to Operations: satellite in-flight commissioning, Image Quality studies, geometry and radiometry expertise

Multisource services based on Deep Learning (DL):

- R&T and feasibility studies
- Solutions prototyping,
- Validation and upscaling
- Execution on specific HW (e.g. SoC-FPGA)

AGENIUM Space expertise relies on a proven know-how in:

- project management
- ICTs for deployment and execution in cloud platforms (devOps).

MAJOR SPACE PROJECTS & REFERENCES

CNES: SI/2A department:

R&T study regarding algorithm part of "Smart Payload". We are currently working on Deep Learning Neural Networks (DNN) simplification using pruning, quantization and distillation methods. R&T study regarding detection and classification of building damages with deep learning.

ESA: ESRIN (PhiLab)

Study (<https://esacortexproject.agenium-space.com/>) to define a workflow to ease the integration and reduction of complex DNN models on Soc-FPGA platforms.

ESA: ESTEC

Study on using DNNs for cloud classification, testing it on a large number of satellite optical images available on Google Earth Engine Database.

AGENIUM Space has submitted to ESA, in the frame of GSTP Make program, a proposal for the development of DNN simplification tools and ad-hoc simplified networks for on-board information extraction and data analysis. The proposal sponsored by the French Delegation as national priority is under evaluation by ESA.

ADDRESS 1 avenue de l'Europe 31400 Toulouse – France

WEBSITE <https://agenium.com/fr/filiale/agenium-space>

PHONE +33 (0)5 61 41 46 40

POINT-OF-CONTACT : FERNANDEZ-MARTIN Christine, COO,
christine.fernandez-martin@agenium.com,
+33 (0)6 22 59 55 43

TURNOVER 0.7 M€

WORK FORCE 8

SPACE TURNOVER 0.7 M€

SPACE WORK FORCE 8

Orbital systems
 Satellites
 Ground segments
 Transversal competencies



Agilink Group with its Microwires division is specialized as electric cables manufacturer. Microwires works high added-value products between 26awg to 36awg.

We can propose solutions for ground or embedded equipments.

COMPETENCIES & CAPABILITIES

We have an engineering office, production and a lab at the same place in Normandy in France. We can propose our standard catalogue or can design custom solution on demand. We work with flexibility and propose small batch for qualifying.

By example, we start multicores shielded cables with moq 10m as prototype.

We test our products for dielectric, fire resistant, flexibility ... with an internal lab. For outgassing, radiation and extreme low temperature we have partnerships with international lab.

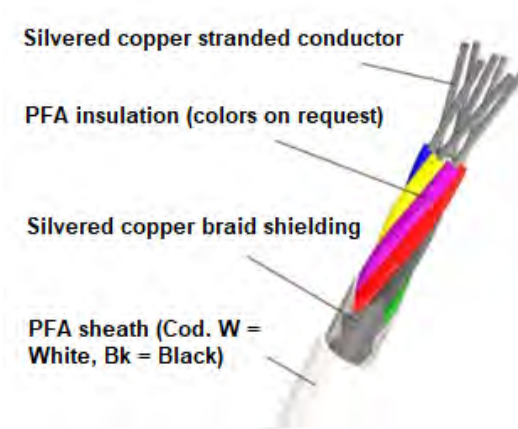

AGILINK - MICROWIRES

PRODUCTS & SERVICES

Our Group design and produce electric cables for various activities. It included aerospace. We can propose small batch for qualifying, medium and high volume for the product life.

We propose single wires, twisted wires with or without shield, multicores shielded cables, 50 & 75 Ohms coax cables, custom solutions ...

We will develop new solutions every year to extend our possibilities and services.

We export in more 50 countries with direct or indirect relationships (Asia, Europe, USA). We propose reactivity and short lead time, included for aerospace.

MAJOR SPACE PROJECTS & REFERENCES

Aerospace activities are quite new for our Group and start at the end of 2021.

We work for measurement equipment at ground as sensors (pressure, temperature, accelerometer ...).

Moreover, we work for embedded solutions with geosat or low atmosphere.

We want to propose standard solutions with time for signal cables or data cables.

POINT OF CONTACT

ADDRESS 1, Place Costes et Bellonte
92270, Bois-Colombes, France

WEBSITE www.agilink-group.com

PHONE +33 (0)1 49 42 21 21

POINT-OF-CONTACT : Mr TISIN, Gilles, Sales Manager
gilles.tisin@agilink-group.com, +33 (0)7 57 48 05 11

TURNOVER around 27 millions euros in 2021 (Group)

WORK FORCE 220 employees (Group)

SPACE TURNOVER new in 2022

SPACE WORK FORCE 12 employees

Orbital systems
Satellites
Ground segments
Transversal competencies



AIKO develops **artificial intelligence (AI)-based software products** for the space industry with the goal of enabling **autonomous space missions**. AIKO's products apply to diverse mission scenarios, including Earth observation, telecommunications, in-orbit servicing, and deep space. Since its founding in 2017, the company has acquired very strong heritage, and has served both commercial and institutional clients. With offices in France and Italy, AIKO currently counts 35 people in its team.

COMPETENCIES & CAPABILITIES

AIKO's key areas of expertise include Machine Learning, Deep Learning, Knowledge-Based Systems, and embedded software design. Its AI-based software products enable the **automation of mission control centers, satellites, and constellations of satellites**.

SCALABLE OPS
OF LARGE
SPACE ASSETS



SMARTER
SATELLITE
OPERATIONS



SUPPORT TO
HUMAN
OPERATIONS



 AIKO

A revolution in the value chain

We revolutionize the space mission value chain and solve the problem of scalability with intelligent operations.

Our technology makes satellite deliver **10x more valuable data**, operations of satellites with our technology incur in **limited and predictable OPEX**, and we enable **scalable operations** on large constellations.

AIKO

PRODUCTS & SERVICES

The functionalities delivered by AIKO's products and services include

- I. payload data processing, e.g., cloud detection and object tracking;
- II. platform data analysis for diagnostics and prognostics of telemetry;
- III. distributed tasking and planning for satellite constellations; and (iv) autonomous manoeuvring, for both station keeping and collision avoidance.

Target customers are satellite manufacturers and operators, as well as governments and public institutions. These players can acquire AIKO's products off-the-shelf or can request customization for their specific needs.

MAJOR SPACE PROJECTS & REFERENCES

AIKO has active contracts with institutions such as the European and Italian Space Agencies, as well as with several industry players, including Thales Alenia Space, GMV, and OHB.

Through its history, AIKO has received several awards and mentions, recognizing strong innovation and validated traction.

POINT OF CONTACT

ADDRESS 13 rue St Ursule
31000 Toulouse
France

WEBSITE www.aikospace.com

PHONE +33 (0)6 16 83 62 41

POINT-OF-CONTACT : BAKER Aurélie, R, France Country Manager
aurelie@aikospace.com , +33 (0)6 16 83 62 41

TURNOVER 1.1 M€ in 2022 and 3M€ expected for 2023

WORK FORCE 35 employees

SPACE TURNOVER 1.1 M€ in 2022 and 3M€ expected for 2023

Orbital systems
Launchers
Satellites
Ground segments
Transversal competencies



Airbus is a leading provider of space and ground systems from space equipment to satellite imagery: Europe's No.1 satellite industrial player, the second largest space company worldwide, world leader for commercial communications satellites, No. 1 exporter of Earth observation satellite systems, No. 2 worldwide in GEO Intelligence, a major contributor to all European interplanetary missions, and the prime contractor for the first European rover that will land on Mars.

COMPETENCIES & CAPABILITIES

As a leading designer and manufacturer of communications, Earth observation, navigation and science satellites, space electronics equipment, ground segments, as well as orbital and space exploration systems, Airbus is continuously investing in innovation to ensure its future positioning in these core segments.

In addition, the ability to provide space-related services through its Connected Intelligence business line enables Airbus to offer end-to-end system packages with satellites, ground segments and operations as fully integrated space solutions to its customers.



AIRBUS

PRODUCTS & SERVICES

Airbus creates innovative and effective space solutions and services, driving the industry forward. We are a leading provider of satellites, space systems, space equipment and satellite imagery. For telecommunication satellites, used for both civil and military applications, such as TV and radio broadcasting, Airbus delivers fixed and mobile communication services and Internet broadband access. Airbus supplies Earth observation (EO) satellite systems, scientific spacecraft and space infrastructure including ground infrastructures for both civil and military applications. Airbus is also an active actor in the Navigation domain, delivering the Galileo Ground Control Segment and EGNOS V3. In the field of Manned Space Flight, Airbus was the prime contractor for the European part of the ISS, the development and construction of the Automated Transfer Vehicle (ATV) cargo carrier, and for the European service module of NASA's next gen. manned capsule MPCV Orion.

MAJOR SPACE PROJECTS & REFERENCES

Airbus is the GEO Telecom satellite market world leader (around 40% market shares in 2019) with the Eurostar and OneSat satellite products. Airbus is at the forefront of innovation with their new product OneSat, the ready-made standard fully reconfigurable satellite, and a pioneer in Telecom mega-constellation manufacturing with its OneWeb Satellites Joint-Venture (648 LEO satellites).

Leader on the EO Science and Navigation satellites market (85 launched, last one CHEOPS in 2016) and provider for EO export customers. In EO & Meteorology, Airbus is developing the next-generation optical constellation CO3D and is leading 5 of 7 Copernicus Sentinels projects to monitor climate change, building MERLIN (methane), the MicroCarb instrument (carbon), and the advanced low earth orbiting meteorological satellite series' of MetOp and MetOp-Second Generation. Our science heritage covers 20 spacecrafts including Rosetta, BepiColombo, JUICE, Solar Orbiter and ExoMars Rover.

POINT OF CONTACT

ADDRESS 31 rue des Cosmonautes
F-31402 - Toulouse - Cedex 4 - France

WEBSITE www.space.airbus.com

PHONE +33 ((5) 62 19 62 19

POINT-OF-CONTACT: Marketing Space Systems
mktg-space-systems@airbus.com

TURNOVER €11,063m (Airbus Defence and Space 2018 Revenues)

WORK FORCE 33 002

SPACE TURNOVER 27% (Space Systems) 21% (CIS)

SPACE WORK FORCE Around 10 000

Satellites

Orbital systems

Transversal competencies



OneWeb Satellites is a joint venture between Airbus, the global leader in the aerospace industry, and OneWeb, the global communications network company.

We design, assemble and test small satellites in high volume thru an innovative mass production assembly line leading to very low cost product.

OneWeb Satellites is offering a standardized platform compatible with many different payloads, providing end-users with cost savings and opening the door to new missions.

COMPETENCIES & CAPABILITIES

- Satellite system and sub-systems design. Expertized in all required domains.
- Low cost and high quality satellites with new space approach
- Satellite assembly with innovative mass production assembly line for the 648 satellites OneWeb constellation
- Benefit of large volume production for any additional small quantities
- Bespoke satellite adaptation to specific payloads based on the standardized platform.



OneWeb Satellites

PRODUCTS & SERVICES

Small LEO satellites

- Use of the standardized bus/platform
- Design of payload, manufacturing and test
- Communication, Earth Observation, Science, or any other specific application
- Satellite design, manufacturing, final assembly and test
- Satellites serial production lines: ability to make satellites for a single demonstrator up to large constellations
- Typical 100kg to 230kg satellite range with ability to increase as needed

Small LEO satellite platform to host customer - payload

- Plug-in of specific payload
- Bespoke interfaces and performances to customer needs

Final Assembly Line set-up:

- Automatisation of mechanical assembly and test
- Big data trend analysis

MAJOR SPACE PROJECTS & REFERENCES

OneWeb constellation first generation (648 LEO satellites for a full Earth coverage) design manufacturing and tests.

- Assembly and test of avionics, AOCS, power, propulsion, structure and communication payload modules.
- Assembly and test at satellite level
- Mass production assembly lines (2 satellites per day)
- Broad supplier ecosystem
- More than 200 hundred satellites already in flight operation

Making satellite platforms to Airbus for other payload types.

POINT OF CONTACT

ADDRESS: 3, rue Tarfaya, 31400 Toulouse - France

WEBSITE: <https://onewebsatellites.com/>

PHONE: +33 6 37 51 38 39

POINT-OF-CONTACT: Laurent DUROU, Head of European New Business, Laurent.durou@airbus-oneweb.com, +33 6 37 51 38 39

TURNOVER: 22.7 M€

WORK FORCE: 290 employees (100 based in France, 100 based in USA, and 90 operating the USA assembly line)

SPACE TURNOVER: 22.7 M€

SPACE WORK FORCE: 290 employees (100 based in France, 100 based in USA, and 90 operating the USA assembly line)

Orbital systems
Launchers
Satellites
Ground segments
Balloons
Transversal competencies

AIRBUS

AIRBUS PROTECT has been defining and implementing a technical, human and operational holistic Risk Management approach for our customers. Our expertise in Safety Security and Sustainability topics has been recognized within the Aerospace, Mobility, Defence & Energy industries for over 35 years.

We advise, provide studies and analysis, to reach the highest standards or certification when required. AIRBUS PROTECT offers digital solutions with a high level of scientific and technological integration using agile and innovative methods.

COMPETENCIES & CAPABILITIES

Expert in Risk Management:

- ✓ Safety - RAMS
- ✓ Security - Cybersecurity
- ✓ Sustainability
- ✓ Training
- ✓ Digital Solutions

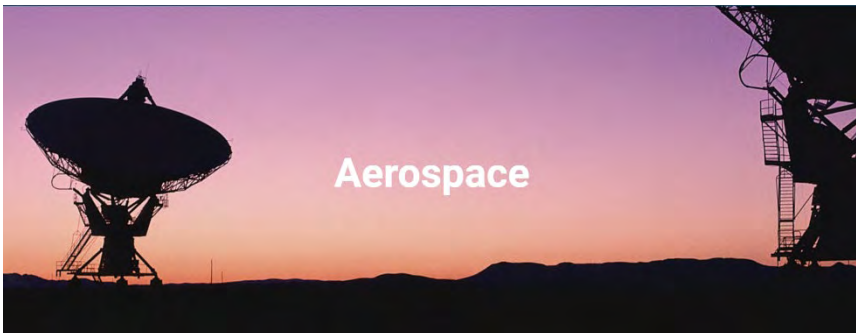

AIRBUS PROTECT

PRODUCTS & SERVICES

Safety compliance & qualification

- ✓ Regulatory compliance, standards (ECSS standards)
- ✓ RAM & Safety architecture definition of Space Products (antenna, satellites, ground segments, launchers...)
- ✓ Design process assurance Hardware & Software (consulting, audits, architecture optimization)

Security /Cybersecurity:

- ✓ Architecture & System Design – Data Protection – Security Governance – Security Risk Analysis

Sustainability: Industrial & Global Risk Assessment, Management & Compliance

Training: 30 Courses available - French training school registered - Datadock - Qualiopi certified

Digital Solutions: RAM & Safety modelling and simulation of complex systems and optimization of Space products. eg: SimfiaNeo, Simlog-ILS tool

MAJOR SPACE PROJECTS & REFERENCES

Projects:

- ✓ EGNOS – THALES ALENIA SPACE
- ✓ ARIANESPACE - ARIANE 5 & 6
- ✓ CNES CALLISTO - CNES DLA
- ✓ VEGA
- ✓ SOYOUZ FREGAT
- ✓ CNES CSG

Customers:

ESSP – APAVE – EUMETSAT - AIRBUS DS (ex ASTRIUM FRANCE and GMBH) – THALES – AIRBUS – ARIANE GROUP – CNES - ESA

POINT OF CONTACT

ADDRESS: 36 Rue Raymond Grimaud, 31700 Blagnac, France

WEBSITE <https://www.protect.airbus.com/>

PHONE +33 (0) 05 61 30 99 00

POINT-OF-CONTACT: MACHADO Marina, Sales Manager
marina.machado@airbus.com, +33 (0)6 29 65 69 99

TURNOVER: 160 M€

WORK FORCE: 1200 employees

SPACE TURNOVER: 2,75 M€

SPACE WORK FORCE: 22 employees

Transversal competencies



AirMems offers innovative electronic switching solutions shrinking size, reducing power consumption and improving the electrical performances of your circuits.

COMPETENCIES & CAPABILITIES

- designs and fabricates a specific compact electronic switch for radiofrequency applications
- designs and fabricates a specific radiofrequency circuits

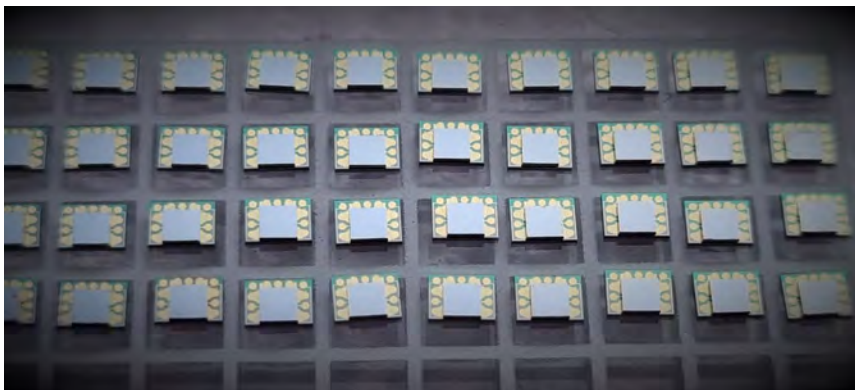

AIRMEMS

PRODUCTS & SERVICES

The AirMems micro-relay relies on a patent portfolio and a strong knowledge in MEMS fabrication process. Its advanced features allow this cutting edge technology to provide many advantages compared to typical switches, especially on:

- the figure of Merit
- the signal integrity preservation
- the size
- the power consumption
- the speed
- the reliability

MAJOR SPACE PROJECTS & REFERENCES

MEMO project: MEMS technology sent in space for functional validation in orbit.

POINT OF CONTACT

ADDRESS 2, Rue Edouard Michaud, Limoges, France

WEBSITE www.airmems.com

PHONE +33 (0)6 75 47 13 82

POINT-OF-CONTACT : STEFANINI Romain, CEO, contact@airmems.com

TURNOVER -

WORK FORCE -

SPACE TURNOVER -

SPACE WORK FORCE -

Orbital systems
Satellites
Transversal competencies



An international engineering and technologies consulting group at the forefront of the digital and connected world, AKKA Technologies is accelerating innovation for the world's largest industrial groups.

AKKA Technologies has a unique ability to leverage its expertise and strength in innovation for the benefit of customers in several sectors: life sciences, space, energy, defense, oil & gas and telecommunications.

For over 25 years, AKKA Technologies supports its space customers with a global offer that encompasses the entire sector with a multi-skill & Expertise in a single company

COMPETENCIES & CAPABILITIES

- On-board / off board SW development & validation
- Test means & numerical models
- Satellite database SW development
- Mechanical & Thermal Engineering
- Instruments testing
- Attitude and orbit control system
- Functional chain validation
- Assembly integration and test
- Satellite operations
- Image Processing & Data Analysis



AKKA TECHNOLOGIES

PRODUCTS & SERVICES

AKKA Technologies, a specialist in High Technology Engineering and Consulting, supports industrial players at all stages of their projects, from R&D to design to mass production.

Through its wide presence in Europe (France, Belgium, Germany, Italy, UK, Switzerland, Poland, Romania, ...) and in the world (Canada, United States, Emirates, Abu Dhabi, ...), AKKA Technologies, by mastering complementary fields of expertise, provides real added value to industrialists in key segments such as automotive, aeronautics, space/defence, consumer electronics, telecommunications, chemicals, pharmaceuticals, steel making, energy, rail, and is recognized by key clients in each of these segments. Thanks to highly mobile teams and its international position, AKKA technologies takes part in cutting-edge projects across the globe.



MAJOR SPACE PROJECTS & REFERENCES

- Software engineering: Rosetta, Doris, GlobalStar, Vega Launcher, Ariane 5 & 6, Neosat, Jason, Insight, Iridium NEXT, BepiColombo, Spot, Lisa Path Finder, platforms E3000, AS250, ...
- Systems engineering and RAMS
- Mechanical & Thermal Engineering : Ariane 6, Space Plane, MTG, CSO, GlobalStar, Neosat, Stratobus...

Our reference customers: Airbus Defense & Space, Thales Alenia Space, Telespazio, CNES, ESA, ArianeGroup, OHB, CLS, Mercator, Hemeria, ...

POINT OF CONTACT

ADDRESS	Bât. Andromède 7, Boulevard Henri Ziegler 31700 Blagnac – France	Space Camp 4 allées des Cormorans 06150 Cannes - France
----------------	--	---

WEBSITE www.akka-technologies.com/

PHONE +33 (0)5 36 25 10 00

POINT-OF-CONTACT: **Nathalie CHIURULLA** Global Account Manager Space
nathalie.chiurulla@akka.eu +33 (0)6 67 16 73 67

TURNOVER 1800 M€

WORK FORCE 21000

SPACE TURNOVER 65 M€

SPACE WORK FORCE 700

Ground segments
Launchers
Transversal competencies



Alcadia Entreprises has been working for nearly 20 years with major industrial contractors for the realization of major projects such as the construction of Ariane 5, Soyouz, Vega, Vega-C and Ariane 6 launch complexes at the Guiana Space Center, and on new generation nuclear reactors. With over 120 employees, Alcadia Entreprises is recognized as a key player in engineering and technology consulting and stands out for its expertise in niche issues.

COMPETENCIES & CAPABILITIES

Our fields of expertise cover the following activities: Systems Engineering, Facility commissioning, Risk Management, Operations and Maintenance Engineering, Project management, Quality and quality controls and Safety studies.



ALCADIA ENTREPRISES

PRODUCTS & SERVICES

Here is a rapid breakdown of the company global activities, in percentage of its annual turnover:

- Systems engineering (28%)
- RAMS studies and risk management (15%)
- Operation and maintenance engineering (12%)
- Commissioning and start-up engineering (12%)
- Business Manager and contractual management (10%)
- Quality and quality controls (10%)
- Project management and Project risk management (8%)
- Various (5%)

We have partnered in several major industrial projects for the European space sector the last 20 years, in Europe mainland and in French Guyana. Some of the company's references are described in the section below.

MAJOR SPACE PROJECTS & REFERENCES

- **CNES**: Design, commissioning and support in operational conditions (MCO) of Ariane 5, Ariane 6, Vega and Soyouz Launch Complexes, EPCU (Payload Preparation Facilities) and BEAP (solid stages firing test bench), as well as system risk analysis for Vega and Vega-C ground and launcher segments, and Safety analysis on pyro systems and reusable vehicles.
- **ArianeGroup**: Support in the development of a rocket engine (Space Plane) and its subsystems. Preparation of Ariane 6 facilities maintenance industrial contracts.
- **Arianespace**: Full redesign the of the CSG's Payload Preparation Facilities (EPCU) User Manual.
- **ESA**: Operational safety, mission compliance with space regulations, crisis plan definition and crisis management procedures for IXV, Space Rider vehicles and Vega-C. Safety operators during IXV launch and flight.
- **APCO**: Reliability studies for A6 liquid stages transport containers and for Upper Composite integration dock in BAF.
- **Regulus**: Preparation and follow-up of maintenance activities of production means.

POINT OF CONTACT

ADDRESS ALCADIA Entreprises
208 rue Garibaldi 69003 LYON - FRANCE

WEBSITE www.alcadia.fr

PHONE +33 (0)4 72 84 00 77

POINT-OF-CONTACT : ARNODO, Cyril, Business Manager – Space Sector,
cyril.arnodo@alcadia.fr, +33 (0)6 25 56 03 48

TURNOVER 13,2 M€

WORK FORCE 113

SPACE TURNOVER 3,8 M€

SPACE WORK FORCE 30

Consultancy services



Aldorane is a French consulting firm based in Toulouse, specialized in supporting the development of innovation and the growth of NewSpace companies.

COMPETENCIES & CAPABILITIES

Aldorane brings the following competencies:

- Strategic analysis, business plan
- Market development, partnerships, international gotomarket
- R&D project set-up and management
- Innovation development and launch

These competencies are backed-up by a strong knowledge of the space ecosystem and the challenges it faces.

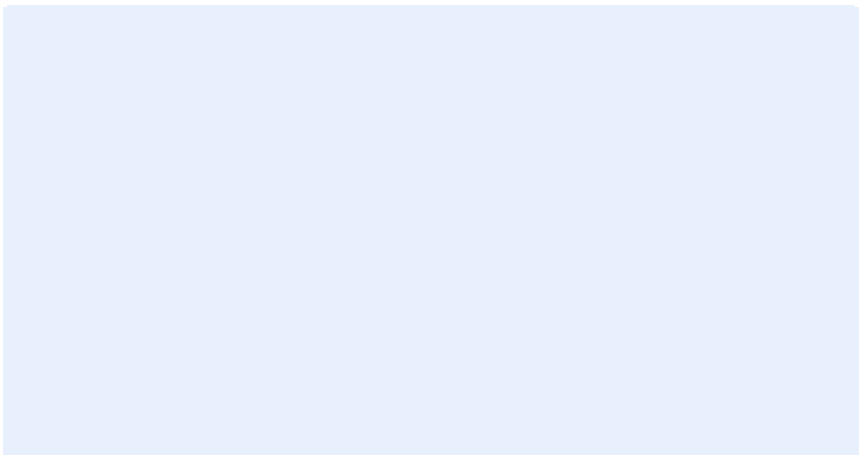

ALDORANE

PRODUCTS & SERVICES

Aldorane services are based on the experience of Marc Leminh, its founder. Marc has 30+ years of experience in the space sector especially in the development of applications using space tech and how to make innovation useful. Marc has also an entrepreneurial experience as he developed and managed for 15 years a telematics company making heavy use of GNSS and satcoms.

More information can be found at <https://www.linkedin.com/in/marcleminh/>

MAJOR SPACE PROJECTS & REFERENCES

Some of the projects supported by Aldorane:

- Study of GNSS impact on rail modal shift
- Study on GNSS chipset shortage
- Study on LEO PNT opportunity signals
- French Newspace ecosystem mapping
- Coaching and mentoring of various start-ups
- Setting-up of several new companies
- Project on space tech used for UAM and cargo drones
- Support to the organization of the European Space Week

Customers include EUSPA, ESA, CNES, various start-ups

POINT OF CONTACT

ADDRESS 9 Avenue Collignon
31200 Toulouse France

WEBSITE www.aldorane.com

PHONE +33 (0)6 86 07 74 62

POINT-OF-CONTACT : Marc Leminh, CEO, marc.leminh@aldorane.com

TURNOVER 0,1 M€

WORK FORCE 1

SPACE TURNOVER 0,1 M€

SPACE WORK FORCE 1

Ground segments
Transversal competencies
Satellites



ALLIANCE4U is a company specializing in digital transformation, strongly committed to its values of Transparency, Proximity, and Reactivity.

Based in Toulouse, the company's 200 consultants provide end-to-end support to its industrial partners. The company's DNA includes a strong culture of the space industry.

COMPETENCIES & CAPABILITIES

The company's services include software and system engineering activities covering specifications, development, IVV and innovation.

Additionally, several experts with doctoral degrees in astrophysics, physics, neurosciences, and other fields work on industrial projects. There is also a community of space enthusiasts involved in innovation and research activities.

Alliance 

ALLIANCE4U

PRODUCTS & SERVICES

Alliance4U offers IT Services:

- Technical assistance
- Fixed commitment
- Consulting

MAJOR SPACE PROJECTS & REFERENCES

- Airbus Defence and Space
Ground segment development and IVV
- Airbus Intelligence
IVV Geo Data Store
- CNES
Control command center development (ISIS), DevOps and Agile methodology implementation (CO3D, Hysope II), Product Owner (Enterprise tools project)
- New Space
Validation

POINT OF CONTACT

ADDRESS 11 rue du Professeur Pierre Vellas, bâtiment Nemesis
31300 Toulouse

WEBSITE www.alliance4u.fr

PHONE +33 (0)5 61 59 32 08

POINT-OF-CONTACT : Olivier Rondeau, Directeur d'Agence
olivier.rondeau@alliance4u.fr / +33(0)628463369

TURNOVER 15 M€

WORK FORCE 200 employees

SPACE TURNOVER 2,5 M€

SPACE WORK FORCE 22 employees

Orbital systems
 Launchers
 Satellites
 Ground segments
 Transversal competencies



ALLEN

ALLEN supports its customers' development strategies in the areas of innovation, R&D and information systems.

Created 30 years ago and based in more than 25 countries, the Group has established itself as a world leader in Engineering and Technology Consulting.

We are a key actor partner in the Aeronautics & Space, Defence & Naval, Security, Automotive, Rail, Energy, Life Sciences, Finance, Retail, Telecommunications and Services sectors.

COMPETENCIES & CAPABILITIES

In the Space sector, ALLEN deploys technical skills to support its customers on their most innovative projects with high added value:

- **Multi-specialists:** **Flight Mechanics/AOCS**, **Mechanical Structure**, **Embedded System** (electronics and software) and **Ground Segment** (infrastructure deployment, IVV).
- **Digital:** **IT & Networks** (Agile, Big Data, AI, Cloud, Cybersecurity, UX/UI design...) / **Ground Segment applications development**.
- **Expertise:** in **AIT** (Assembly, Integration & Test), **Electrical and Avionics** Architecture Design, Simulation and Validation of **Optical Instruments**.



LAUNCHERS



SATELLITES

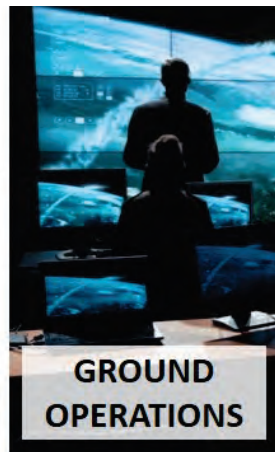

GROUND OPERATIONS

ALTEN

PRODUCTS & SERVICES

ALTEN's services are deployed across three business lines:

- **Space launchers:** Mechanical design & analysis, Thermal Models, Quality, Trajectory and Orbit control, Aerodynamic calculation, Flight Path Monitoring
- **Satellites:** Global Assembly-Integration-Tests services, Avionics system design & validation, On-Board software & electronics, Instruments (optical, RF, science), Mechanical design/analysis/assembly, Thermal analysis, Thermal Protection Systems design, Attitude & Orbit Control Systems validation, Propulsion validation
- **Ground operations:** System & network administration, Software development & validation, Infrastructure design, IVV, Inboard Systems.

Our major Customers: CNES, Airbus D&S, Thales Alenia Space, CLS, ULA, CRISA, Oneweb Satellite...

MAJOR SPACE PROJECTS & REFERENCES

- **The European launcher Ariane 6:** as a historical partner, ALTEN actively participates in their development in various fields (structure, thermal, flight mechanical engineering, etc.)
- **Satellites' AIT:** ALTEN capitalizes on more than 20 years of know-how in preparations for the assembly, validation tests and final integration of various satellites for CNES and other industrial customers as TARANIS, SVOM, METOP-SG, JUICE, EUTELSAT10B, etc.
- **Mini-satellites:** ALTEN has been involved in the Structure and Payload design of a constellation of 900 mini-satellites in a low orbit with ONEWEB.
- **Image processing chain engineering:** ALTEN is involved in the study, development and maintenance of the complete image processing chains for the satellite observation systems of a major player in the space sector (IASI-NG, SUPERCAM, EUCLID, OLCI, MICROCARB, OTOS, etc.)

POINT OF CONTACT

ADDRESS : 40 Avenue André Morizet
Boulogne-Billancourt – France

6 rue Ampère
31670 Labège - France

WEBSITE: <https://www.alten.com/sector/space-engineering/>

PHONE: +33 (0)5 34 42 73 00

POINT-OF-CONTACT: **ROQUES, Mathieu** - Division Director
mathieu.roques@alten.com, +33 (0)5 34 42 73 85

TURNOVER: 2.6 billion euros

WORK FORCE: 37,200 employees

SPACE TURNOVER: 55 million euros

SPACE WORK FORCE: 750 Space Engineers in 10 countries

Orbital systems
Transversal competencies



Our mission is to provide our customers best in class engineering services, test services and radiation expertise in electronic devices, dies, modules and equipment within harsh environment markets, based on quality management excellence.

Our staff of highly skilled and trained engineers and technicians has many years of accumulated knowledge in semiconductor and equipment for high-reliability space, aeronautic and industrial applications.

COMPETENCIES & CAPABILITIES

- Electrical Testing: Analog, Digital, Mixed Signal, RF, Passive, Discrete & Power devices...
- Extreme temperature testing capability (-80°C to +300°C)
- Wafer Electrical Testing (Probe) - Up to 8" (200 mm) wafer size
- Mechanical & Environmental Testing - Fully equipped for product qualification to address MIL, ESCC, AEC-101 and JEDEC requirements.
- Technical expertise with appropriate tools from non-destructing analysis to deep-dive physical analysis
- Sample preparation for radiation test. All specific requests are covered with innovative solutions (microwave induced plasma technique).
- 3D nanofocus X-Ray tomography.

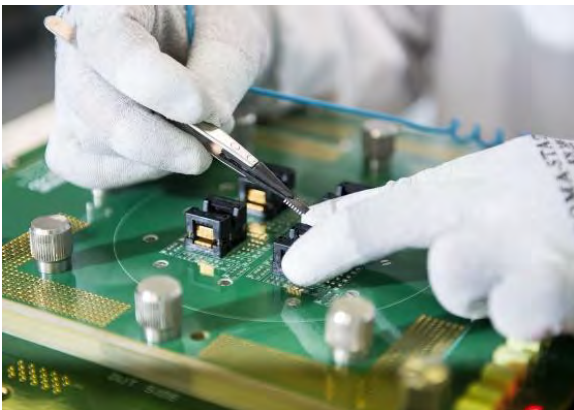

Alter Technology France

PRODUCTS & SERVICES

- Electrical, Environmental and Mechanical tests
- Wafer Electrical Testing (Probe)
- Reliability tests (Burn-In, HTOL, HTRB/HTGB, HAST, THB ...)
- FPGA & PROM – Programming & PPBI
- Radiation Testing - Total dose COBALT 60 (TID)
- Radiation Testing – Single Event Effects (SEE)
- Failure analysis
- Construction Analysis
- Reverse Engineering
- Destructive Physical Analysis
- Counterfeit Control
- Project Management and Technical Assistance
- Support for **New Space** Activities
- EEE Parts Procurement Service

MAJOR SPACE PROJECTS & REFERENCES

Space programs:

- KaSat, Galileo, Hotbird 2 to 10, Sicral, Stentor, W3A to W3D, W5A, Inmarsat IV, Quantum, BB4A
- CSO, Cbers, Envisat, Helios 2, MHS (Microwave Humidity Sounder), Spot 5
- SARAL, Solar Orbiter, ExoMars, MSL 09, Picard, Megha Tropic, Bepi Colombo, Herschel Planck, Cassini, Integral, IASI, Rosetta, Mars Curiosity, JUICE
- Ariane 5 & 6
- Taranis and Exomars CPPA

Aeronautic programs: A350, FADEC, LEAP, Silvercrest, SiCRET
Robustesse, Feline

Defense: Pistis

Automotive programs: VTT, iStar, Mhygale, GaNRET

ADDRESS 2 rue des satellites - 31520 Ramonville Saint-Agne

WEBSITE <https://www.altertechnology-group.com/en/company/alter-technology-france/>

PHONE +33 (0)5 62 47 56 90

POINT-OF-CONTACT : Pierre Fontana – Sales Manager
p.fontana@altertechnology.fr - +33 (0)5 62 47 56 90

TURNOVER 7.2 M€

WORK FORCE 49 employees

SPACE TURNOVER 4.6 M€

SPACE WORK FORCE 31 employees

Transversal competencies



AMCAD Engineering provides measurement, modeling and simulation solutions for Radio Frequency (RF) and microwave components for the design of electronic circuits or subsystems.

Our mission is to help our customers to design highly efficient communication systems at every stage of the product lifecycle, while reducing time to market.

COMPETENCIES & CAPABILITIES

Transistor measurement and modeling for circuit design

RF and Microwave Circuit Design

Circuit measurement and behavioral modeling

System Simulations using behavioral models

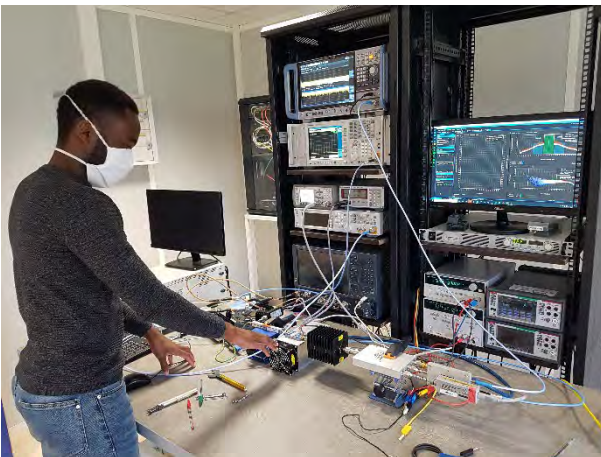

AMCAD ENGINEERING

PRODUCTS & SERVICES

AMCAD offers integrated turnkey solutions, enabling our customers to accurately perform their measurement/modeling/simulation work, to accelerate and secure their design flow using the various IVCAD, IQSTAR and VISION software platforms.

We also offer a wide range of services thanks to our measurement laboratories equipped with the latest generation of RF and microwave hardware.

Our tests can start at the unit component level (including on-wafer measurements), up to the characterization of complex systems made up of a variety of circuits, such as amplifiers, mixers, filters, digitally controlled circuits, for the overall system simulation.

MAJOR SPACE PROJECTS & REFERENCES

AMCAD provides different measurement and modeling services to Original Equipment Manufacturers involved in space industries.

(Thales Alenia Space, Syrlinks, ...)

AMCAD won different CNES and ESA tenders in the frame of different consortium to provide best-in-class transistor measurement and models to design high-efficiency RF amplifiers.

POINT OF CONTACT

ADDRESS 20 Rue Atlantis
87000 Limoges France

WEBSITE www.amcad-engineering

PHONE +33 (0)555040531

POINT-OF-CONTACT : Fumet, Laurence, Executive Assistant
fumet@amcad-engineering.fr, 05 55 04 05 31

TURNOVER 3 M€

WORK FORCE 17 employees

SPACE TURNOVER 0.2 M€

SPACE WORK FORCE 1 employee

Orbital systems
Launchers
Satellites
Ground segments
Transversal competencies



Ametra Group, an integrating engineering company, has designed and integrated complex systems for industrial customers, for over 40 years.

Our DNA is based on multi-domain expertise, understanding of customers' requirements, agile project management, constant pursuit of innovation and competitiveness, as well as operational excellence.

Our design offices and manufacturing sites are based in France, in low cost country and in India (Offset).

COMPETENCIES & CAPABILITIES

Ametra Group covers the various fields of mechanics, electricity, electronics, system integration and manufacturing allows you to rely on a single partner for all your space projects.

Ametra Group proposes some modes of intervention closely adapted to your needs:

- Outsourced Package
- Engineering Support
- Service Center

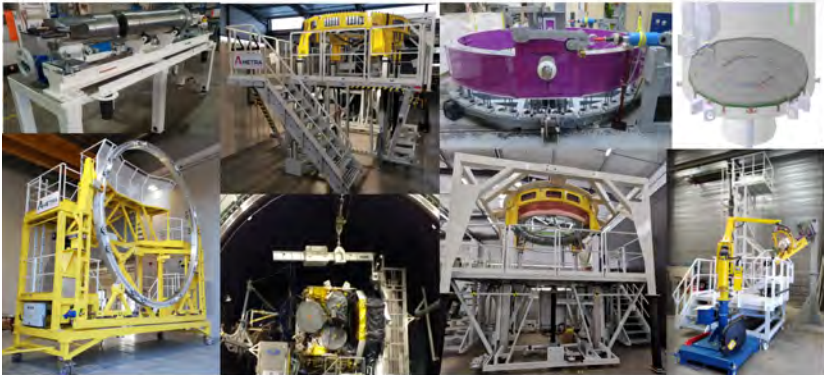

AMETRA GROUP

PRODUCTS & SERVICES

Scope of products:

- Industrial means / MGSE
- Specific tools
- Test benches
- Electrical systems and harnesses
- Prototype

Scope of services:

- Project management
- Engineering (products and tooling)
- Mechanical dimensioning and justification
- Documentation
- Industrialization
- Manufacturing and assembly
- Tests & qualifications
- On-site installation

MAJOR SPACE PROJECTS & REFERENCES

Ariane 6:

- Assembly means (based in France and Kourou)
- Transfer means
- Integration means
- Lifting means
- Test bench (dynamic and static)
- Access floor

Satellite (INMARSAT 6, SYRACUSE 4...):

- Assembly means
- Lifting means

Nanosat:

- Product Engineering (Structure)
- Assembly means

POINT OF CONTACT

ADDRESS: Parc de Cabanis – 6 rue de Cabanis - 31240 L'Union, France

WEBSITE www.ametrargroup.com

PHONE +33 (0)5 62 72 12 66

POINT-OF-CONTACT: MARMOING Nicolas, Director of Operations

n.marmoing@ametrargroup.com, +33 (0)6 32 83 14 79

TURNOVER 50 M€

WORK FORCE 700 employees

SPACE TURNOVER 5 M€

SPACE WORK FORCE 90 employees

Satellites
Transversal competencies

ANYWAVES
SPACE ANTENNA MAKERS

Anywaves, a CNES (French Space Agency) spin-off, develops innovative antennas for satellites constellation and launchers.

Based on breakthrough technology and an expert team mainly composed of PhD on advanced antenna technologies, Anywaves designs and manufactures – on demand or off-the-shelf - a new generation of high-performance and high-quality antennas for space applications such as telecommunications, IoT, navigation, Earth observation, atmospheric input and many others.

COMPETENCIES & CAPABILITIES

Expert in electromagnetism, with a focus on antennas, Anywaves maximizes the performances of all wireless systems and designs high-performance antennas with powerful computation resources and professional electromagnetic software.

Anywaves proposes generic antennas (S-Band TT&C, X-Band Payload Telemetry, All-Band GNSS, GNSS L1/E1 band, cap tests...) as well as payload ones (deployable helixes, antenna arrays...) and has high production capability.



S-Band



X-Band



GNSS All-Bands



GNSS L1/E1 Band

ANYWAVES

PRODUCTS & SERVICES

Anywaves' on the shelf antennas:

- S-Band antennas for TM/TC operating in Tx & Rx
- X-Band antennas for the payload TM
- GNSS All-Bands antenna (GPS, Galileo, Glonass, Beidou, Inmarsat in L-band)
- GNSS L1/E1 band antenna
- Test Caps for S, X and GNSS antennas

Payload antenna design & manufacturing (on request)

MAJOR SPACE PROJECTS & REFERENCES

- o Anywaves has the CNES Advance label and benefits from CNES know-how on space technologies
- o Anywaves is EN 9100 certified since 2020
- o Anywaves space antennas have flight heritage since 2019 and are used by key players all around the world such as Airbus, Thales, OHB Sweden, Maxar, Loft Orbital, Airbus Oneweb Satellite, U-Space, Hemeria, etc.

POINT OF CONTACT

ADDRESS 2, Esplanade Compans Caffarelli
Bâtiment Toulouse 2000 D – Hall D
31000 Toulouse France

WEBSITE www.anywaves.com

PHONE +33 (0 5 31 54 41 56)

POINT-OF-CONTACT: François Morizur – Chief Commercial Officer
francois.morizur@anywaves.eu

TURNOVER 2 M€

WORK FORCE 30+

Ground segments
Launchers
Satellites
Transversal competencies



Apave is an international group specialised in risk management with more than 150 years' experience.

Our 12,400 employees work at the request of our customers, on regulatory or non-regulatory assignments related to risk management. Apave offers services and expertise in 5 areas: Inspection, Training, Testing & Measurements, Certification and Labels, Consulting and Technical Support. Whether for individual safety, site safety and compliance, environmental safety or digital security, Apave continues to fulfil its purpose as a trusted third party to its customers.

“Acting as a trusted player for a safer, sustainable world that brings about shared progress”: this is Apave’s corporate purpose

this is Apave’s corporate purpose.

COMPETENCIES & CAPABILITIES

Our 5 business lines are complementary and enable you to combine safety and performance at every stage of your projects.

Inspection: We check the reliability of your facilities, equipment, structures, infrastructures and buildings to keep them compliant during commissioning as well as operation.

Training: We are the leader in Risk Management and Safety training. Our unique model using trainer-inspectors enables 350,000 people each year to take part in training that culminates in certification, a real credential for their professional futures.

Testing & Measurements: We carry out testing of all types using simulators that reproduce actual stresses. We also take air, water and soil samples and measurements to monitor their quality and better manage your risks and impact on the environment.

Consulting and Technical Support: We help you improve the safety and health of your teams by lowering the industrial accident rates and the risk of incidents.

Certification & Labels: We certify your systems dedicated to management, skills, products or services. We also define labels in line with a strict reference framework.

APAVE - ESQS

PRODUCTS & SERVICES

Apave acts in its own name and as pilot of the European GIE ESQS (Europe Spatial Quality and Safety) on the following activities:

- RAMS studies (reliability, availability, maintainability and safety)
- Risk analysis
- Operational quality, product quality, project quality, quality assurance
- Configuration & documentation management

- Security studies
- Safeguard & environment

- Regulatory controls, technical assistance, compliance and qualification of equipment, technological and regulatory watch, technical expertise

MAJOR SPACE PROJECTS & REFERENCES

Apave uses its skills for the benefit of CNES at the Guiana Space Centre in Kourou, the Toulouse Space Centre and the Launchers Department in Paris, ARIANESPACE at the CSG and in the USA for OneWeb Satellite, STARSEM in Russia and Kazakhstan, AVIO at the CSG and of ESA in Italy.



POINT OF CONTACT

ADDRESS : 11, rue de Tocqueville, 31200 TOULOUSE - FRANCE

WEBSITE www.apave.com

PHONE +33 (0)5 61 37 62 62

POINT-OF-CONTACT : Laurent FAUCHER, head of space agencies
laurent.faugher@apave.com, +33 (0)6 20 82 47 72

TURNOVER 881 M€

WORK FORCE 12 400 employees

SPACE TURNOVER 11 M€

SPACE WORK FORCE 100 employees

Orbital systems
Launchers
Satellites
Transversal competencies



AREELIS Technologies is a French engineering and tests company, specialized in fluid mechanics, mechanics, thermal engineering and cryogenics, providing its products and services in the fields of space, defense and aeronautics.

COMPETENCIES & CAPABILITIES

For space, we are specialized in:

- Assembly, Integration & Testing of Propulsion System
- Cryogenic tests and test benches
- Conception of assembly tools
- Expertise and technical support

Our capabilities include:

- White room ISO 8
- Dedicated test benches
- Tests rooms
- Workshop
- Thermal cycling test benches
- Vacuum Chambers
- Climate chambers

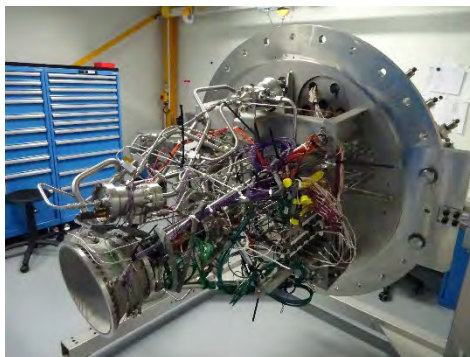

AREELIS TECHNOLOGIES

PRODUCTS&SERVICES

Services:

- Cryogenic and vacuum tests, fluid tests, thermal tests in space conditions
- Test Bench design & manufacturing
- Management of tests engineering from to
- Electronic component testing in harsh environment
- Assembly and mounting for spatial applications and equipment (propulsion systems, satellite panels) in white room ISO 8

Products:

- Test benches (mechanics, fluid mechanics, thermal applications, fire tests, vacuum applications, thermal shocks)
- Scientific and fluid mechanics software

MAJOR SPACE PROJECTS & REFERENCES

Customers:

CNES, ARIANE, CNRS, CEA, THALES, AIRBUS, ...

ARIANE GROUP: Tests of LN2 Motopomp, validation tests on PROMETHEUS COTS equipment

SAFRAN AIRCRAFT ENGINE: Design of a thermal test bench and thermal tests on a heating plate, ON/OFF thermal cycling tests on a heater, Vacuum and thermal system, mechanical tests on PPS® X00 components

ARIANE Works: Design of a test bench for thermal protections

Involved in the following spaces projects:

- BOREAS,
- APU project (ARIANE 6)
- THEMIS
- PROMETHEUS
- CALLISTO

POINT OF CONTACT

ADDRESS 675, avenue Isaac Newton 76800 Saint Etienne du Rouvray France

WEBSITE www.areelis.fr

PHONE+33 (0)2 32 95 14 14

POINT-OF-CONTACT: ROULAND Eric, Director, eric.rouland@areelis.com
+33 (0)2 32 95 14 15

TURNOVER 1 M€

WORK FORCE 10

SPACE TURNOVER 1 M€

SPACE WORK FORCE 10

Orbital systems
Launchers
Satellites
Transversal competencies



ArianeGroup springs from the shared ambition of Airbus and Safran to take the European space industry to the highest possible level. Equally owned by the two groups, ArianeGroup houses the entire scope of their civil and military launcher activities and competences in a single, coherent company, and its roots reach back more than 70 years into the history of space activity in Europe. The network includes 11 subsidiaries and affiliates.

COMPETENCIES & CAPABILITIES

The perfect innovative, highly competitive solution for civil and military launch systems and space applications: ArianeGroup has expertise in the most cutting-edge technologies, from all aspects of complete propulsion systems right down to the items of equipment and materials.

ArianeGroup leverages all of this expertise, the unique knowledge of its teams, into benefiting the space, defense, energy, and other industrial sectors, with high value-added products, equipment and services.



ARIANEGROUP

PRODUCTS & SERVICES

- Launch services to any destination (LEO, SSO, MEO, GEO, Moon, Mars and beyond...),
- For satellites and spacecraft: electrical and thermal (including storable) propulsion systems, high-pressure tanks, antennas reflectors, central tubes, thermal protection, atmospheric reentry systems,
- For launchers: liquid and solid propulsion systems, avionics, high-pressure storage tanks, antennas reflectors, dispensers, thermal protection, atmospheric reentry systems, nozzles extension...
- For defense and security: solid propulsion systems, critical (NRBC) infrastructures, space surveillance and tracking, debris removal, air and space traffic management.

MAJOR SPACE PROJECTS & REFERENCES

- Lead contractor for Europe's Ariane 5 launcher, the most reliable launcher on the commercial market. The last flight on 18th February 2020 was the 106th launch of Ariane 5 and the second of the year 2020.
- Lead contractor for next generation Ariane 6 launcher



©ArianeGroup Holding \ Alban

POINT OF CONTACT

ADDRESS Tour Cristal 7-11 Quai André
Citroën F-75015 Paris, France

WEBSITE www.ariane.group

PHONE +33 (0)1 39 06 39 86

POINT-OF-CONTACT: sylvie.marzocchipolizzi@ariane.group

TURNOVER About 3 billion euros

WORK FORCE Nearly 9,000 highly qualified staff in France and Germany

SPACE TURNOVER Undisclosed

SPACE WORK FORCE Undisclosed

Orbital systems
 Launchers
 Satellites
 Transversal competencies



ARKANE is a French cutting-edge innovative company co-founded by two PHDs in Telecommunication in 2020 at the ENSTA Bretagne Business Incubator. ARKANE specializes in using AI-empowered solutions for Telecommunication systems.

ARKANE develops advanced Machine Learning Techniques to solve complex tasks for IoT protocols and Radar and Smart Antenna signal processing.

COMPETENCIES & CAPABILITIES

ARKANE designs algorithms for IoT protocols and Radar and Antenna digital processing.

ARKANE Machine Learning Models tackle the routing and scheduling protocols for 6LowPAN Networks, Antenna Digital Beamforming and Radar Target detection, tracking and classification.

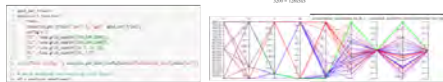
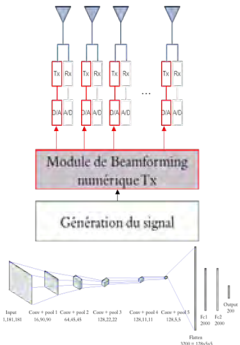
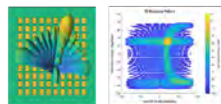
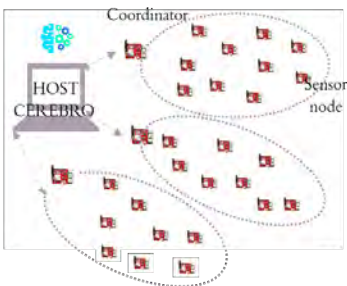

ARKANE

PRODUCTS & SERVICES

- CEREBRO an AI-empowered IoT protocol for fast and reliable data collection in Wireless sensor networks for uses cases such as structural Health Monitoring and Assembly, Integration and Test. CEREBRO is an embedded ML software in a plug and play terminal that scans, builds and manages the data collection in a wireless sensor network.
- Deep Learning algorithms for Antenna Digital Beamforming as an alternative to usual Beamformers that have slow and heavy computation.
- Deep Learning algorithms for target identification, tracking and classification for radar applications working on complex radar data cubes.

MAJOR SPACE PROJECTS & REFERENCES

- CEREBRO a plug and play AI terminal for the SHM and AIT of future launch vehicles. Laureate of the CNES R&D challenge for future space transportation in 2020 & Laureate of the CNES AI for future transportation in 2022
- AITENNA for ML Antenna Beamformers of Telecommunication antennas. Laureate of the CNES AI for future transportation in 2022.
- ESA BIC Alumni & part of the ESA Space Hub.

POINT OF CONTACT

ADDRESS ENSTARTUPS, 2 Rue François Verny, 29200 Brest, France

WEBSITE <http://www.arkane-tech.fr/>

PHONE +33 (0)6 49 21 84 10

POINT-OF-CONTACT: Norbert DUBROCA – Co-founder and CEO.

TURNOVER < 1M€

WORK FORCE 2 to 5 employees

SPACE TURNOVER < 1M€

SPACE WORK FORCE 2 to 5 employees

Orbital systems
Launchers
Satellites
Ground segments
Transversal competencies



Armor Arsenal is a modern pioneer primarily developing innovative Flow Control Equipment for space applications. With a near-term focus on Low Earth Orbit, Armor Arsenal's portfolio includes turnkey Propellant Management Systems, high power electrothermal thrusters, H₂O₂ thrusters, cryogenic storage tanks and relevant Ground Support Equipment.

Armor Arsenal is based in Lannion, France, and occupies 100 m² of offices and clean rooms.

COMPETENCIES & CAPABILITIES

Armor Arsenal leverages its extensive experience of spacecraft design and launch vehicle implementation and performs internally fluidic and propulsion architecture design and functional analysis, detailed design of flow control equipment and propellant management system according to applicable regulations (CNES/CSG range safety, US ASME, etc.), the Assembly, Integration and Test phase of products, and the final quality inspection before delivery. The company relies on a strong and local SMEs network enabling fast reaction time and controlled pricing. Customer oriented, Armor Arsenal delivers space grade systems in accordance with ambitious schedules.

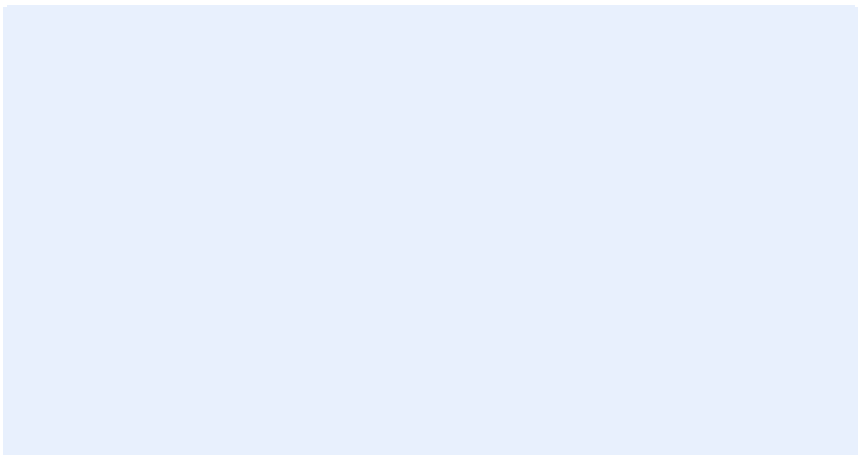

ARMOR ARSENAL

PRODUCTS & SERVICES

Armor Arsenal currently offers:

- Complete, turnkey propellant management systems especially suited for small chemical propulsion and E.P. systems (Hall effect, gridded ion, etc.)
- Standalone components (tanks, valves, pressure reg., FDV, etc.)
- High power (1 – 10 kW) electrothermal thrusters
- 0,1 – 1 kN mono & biprop HTP thrusters
- Engineering support services

The DNA of the company lies in the extensive use of modified COTS components. Hence, the company's range of product can be proposed at reduced prices compared to more traditional products.

MAJOR SPACE PROJECTS & REFERENCES

- Rank 1 supplier of a major French company for in-orbit chemical propulsion system
- Supplier of CNES
- Confidential deals with world-class industrial space leaders

POINT OF CONTACT

ADDRESS Technopole Anticipa, 4 rue Ampère
22300 Lannion, France

WEBSITE www.armor-arsenal.com

PHONE +33 (0)7 83 97 92 04

POINT-OF-CONTACT Lefèvre, Jean-Baptiste, CEO

jean-baptiste.lefevre@armor-arsenal.com, +33 (0)7 83 97 92 04

TURNOVER 1 - 10 M€

WORK FORCE 1 - 10 employees

SPACE TURNOVER 1 – 10 M€

SPACE WORK FORCE 1 - 10 employees

Launchers
Satellites
Transversal competencies



ASB AEROSPATIALE BATTERIES is the unique company in Europe to master research, design and production of Thermal Batteries. Mainly integrated in missiles and ammunition in general, ASB Thermal Batteries are also equipping the latest space launchers ARIANE 6 and VEGA-C. As well, our Thermal Batteries are currently used as emergency power systems in aircrafts, in case of landing without engine service. The satellites to be placed in and out of their orbits can also use Thermal Batteries technology.

COMPETENCIES & CAPABILITIES

ASB develops Thermal Batteries which are top class performances, with the highest level of reliability:

- specific power over 5.5 kW/kg,
- without variation of performances from -50 to over +70°C,
- without any maintenance for 15 years,
- from some Watts up to 70 kW per battery, corresponding to some grams up to over 20 kg.



ASB AEROSPATIALE BATTERIES

PRODUCTS & SERVICES

ASB group is world n°1 of the thermal batteries. ASB headquarters and electrochemistry center of excellence is based in Bourges, France. The group has autonomous subsidiaries in UK/MSB, in USA/ATB and in India/APS & VAR. We are able to address all kind of requirements concerning thermal batteries.

ASB capabilities includes prototypes & big series, with the largest dimensions and performances all over the world. ASB Group has a capability of over 120,000 batteries a year.

Each customer specification leads to a specific optimized definition for Defense security reason. ASB is covering the largest portfolio (over 100 different types of Thermal Batteries are currently under production inside the Group).

MAJOR SPACE PROJECTS & REFERENCES

The ASB thermal batteries are used for Thrust Vector Actuator electrical power, as well as to bring power to satellites exit motor from the launchers, and other power supplies integrated inside the space launchers.

Small ASB thermal batteries can be used for any single action needed by satellites: e.g. to deploy solar cells, or to get out of the orbit at the end of life, etc. A small thermal battery is sufficient as its specific power is high.

Ariane 5 & 6, VEGA-C, use and will use ASB thermal batteries.

Other launchers programs are interested and under advanced discussions in Asia.

Our US subsidiary ATB is involved in US space programs.

POINT OF CONTACT

ADDRESS Allée Sainte-Hélène, 18021 Bourges Cedex France

WEBSITE www.asb-group.com

PHONE +33 (0)2 48 48 56 05

POINT-OF-CONTACT : NICOLAS Christophe, Group Sales & Programs Executive, ch.nicolas@asb-group

TURNOVER

WORK FORCE 350 employees in the Group

SPACE TURNOVER

SPACE WORK FORCE

Launchers
Satellites
Transversal competencies

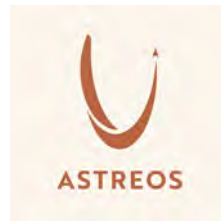

Astreos streamlines the launch experience of any project by taking care of every aspect of the mission, from cost estimates, manufacturing, insurance to transportation to launch brokerage in order to optimize the time spent and decrease the costs.

Astreos addresses mainly small satellite operators/manufacturers to support their journey to orbit.

COMPETENCIES & CAPABILITIES

- Mission Management
- Cost estimates
- Market studies
- Insurance
- Licensing
- Transportation and customs
- Deployer sourcing
- Integration Services
- Tests
- Launch brokerage
- Post-launch Services



ASTREOS

PRODUCTS & SERVICES

Astreos is a brokering company providing services intended to smallsats operators and manufacturers. We offer “factory to orbit” or “idea to data” support enabling time and cost-control to a wide range of organizations or individuals aiming at sending a payload into orbit. We have signed agreements with partners in each field of services to provide our clients with a thorough experience: market studies, cost estimates, insurance, licensing, mission management, transportation, satellite testing and the launch operator and deployer sourcing.

MAJOR SPACE PROJECTS & REFERENCES

- Costs estimates
- Launch manifests study
- Constellation deployment strategy study
- IOD/IOV study for CNES
- Development of deployer with Comat

POINT OF CONTACT

ADDRESS 23, rue Rosa Luxembourg
51100 France

WEBSITE www.astreoslaunch.com

PHONE +33 (0)6 60 06 95 85

POINT-OF-CONTACT : Cambourian, Clémence, Chief Operating Officer,
clemence.cambourian@astreoslaunch.com, +33 (0)6 60 06 95 85

TURNOVER N/A

WORK FORCE 5 employees

SPACE TURNOVER N/A

SPACE WORK FORCE 5 employees

- Launchers
- Satellites
- Ground segments
- Balloons
- Transversal competencies



Atem is a French SME which designs and builds tailor-made coax cable assemblies for RF and microwave applications for ASD markets (Aeronautic, Space, Defence). Atem helps their customers to choose the rightful RF components for their applications. Atem leads also engineering studies to conceive complex RF and microwave subsystems for embedded systems or RF test benches. Atem is also the owner of VN Composites, which allows Atem to propose technical composite parts on demand.

COMPETENCIES & CAPABILITIES

- Design, manufacturing & measurement (S parameters) of coax cable assemblies (up to 40 GHz)
- Design, manufacturing & measurement of RF subsystems (CAO, RF chain simulation, VNA & analyser, testing all the subsystem)
- RF & microwave expertise on systems
- Prototyping and manufacturing of composite parts (glass fiber, carbone fiber, linen fiber, etc.) with an accurate knowledge regarding the processes (infusion, resin transfer modelling, drapping, autoclave, composite molded by compression...)

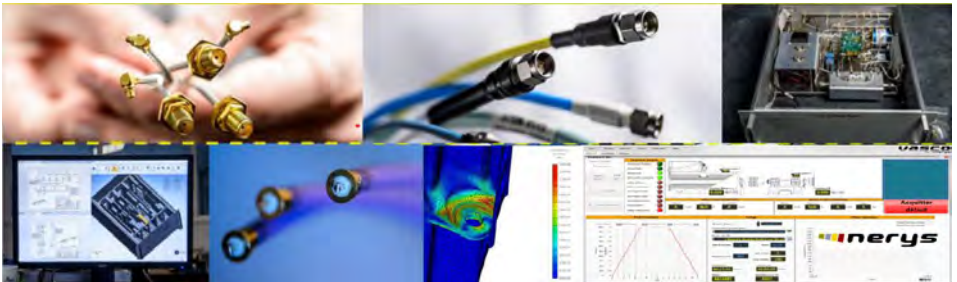

ATEM

PRODUCTS & SERVICES

- Tailor made coax cable assemblies (up to 40 GHz)
- Design and manufacturing of RF & microwave subsystems
- Tailor made composite technical parts

MAJOR SPACE PROJECTS & REFERENCES

- Coax cable assemblies kit for ARIANE launchers (telemetry, trajectories)
- Space testing facilities coax cables (TAS, CNES, etc.)
- Composite parts to deploy the solar panels for TAS' satellites

POINT OF CONTACT

ADDRESS ZA La Poulasse, 4 rue de Strasbourg
83 210 Solliès-Pont - France

WEBSITE www.atem.com

PHONE +33 (0)4 94 13 04 96

POINT-OF-CONTACT : HENNETIER, Bruno, Project manager,
bruno.hennetier@atem.com, +33 6 86 43 87 33

TURNOVER 2,8M€

WORK FORCE 18 employees

SPACE TURNOVER 0,15 M€

SPACE WORK FORCE 8-10 employees

Orbital systems
 Launchers
 Satellites
 Ground segments
 Balloons
 Transversal competencies



Group ACB is a Printed Circuit Board manufacturer, we have three factories working on the high technology and high reliability sectors including Space and New Space industry.

We offer Quick Turn Around production and standard leadtime in small or medium quantity.

Our factory Atlantec is specialist in high frequency application such as antenna, radar applications, Flexible, Flex-rigid PCB and others for high reliability applications.

COMPETENCIES & CAPABILITIES

Group ACB – Atlantec factory is working for several small sat, cube sat, nano sat and LEO/MEO program especially for the PCB based Antenna in material such as PTFE and others high frequency material. We also produce PCB for calculation unit, power conversion and other electronics application used in satellite, satellite sensors and imager or other equipment's. We work from the early steps of the project offering mock-up manufacturing up to ESA qualified space model (can be in Atlantec or in ACB factory withing a ESA PID).

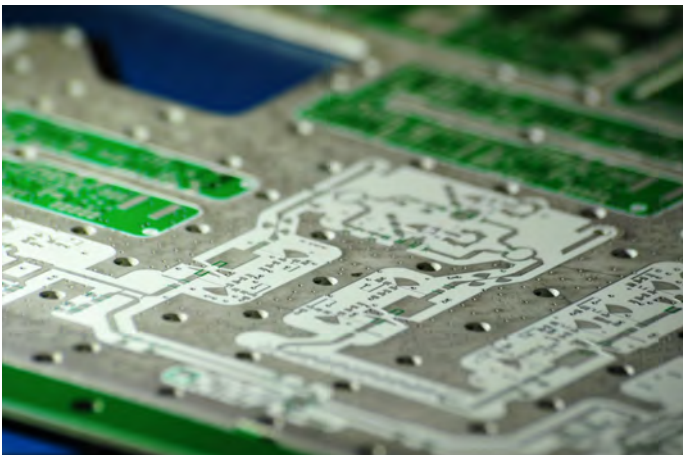

ACB - ATLANTEC

PRODUCTS & SERVICES

Manufacturing of your PCB:

- Rigid
- Sequential Rigid
- HDI Rigid
- Flexible
- Flexible-Rigid
- Flexible-Rigid HDI
- IMS
- CIC
- Special thermal management solutions
- High frequency (several materials including PTFE, ETFE, Hydrocarbon-Ceramic, PPE/MPPE...)
- Specials

MAJOR SPACE PROJECTS & REFERENCES

ESA Heritage within the group on several Satellite program from 2016 (sentinelle, Galileo, Proba...).

POINT OF CONTACT

ADDRESS ZI de la Croix Blanche
44260 MALVILLE France

WEBSITE www.acb.be

PHONE +33 (0)6 74 59 03 63

POINT-OF-CONTACT : Kevin TASTETS, Group Sales Director
ket@acb.be, +33674590363

TURNOVER 7,5 M€

WORK FORCE 65

SPACE TURNOVER 0,71 M€

SPACE WORK FORCE 5

Orbital systems
 Launchers
 Satellites
 Transversal competencies



ATMOSTAT provides the design, manufacturing and justification of critical mechanisms and electro-mechanisms in the fields of defense, aeronautics, space and scientific instrumentation with high levels of safety and reliability.

This equipment are parts of safety functions, propulsion, fluid flow management, measurement sensors, vibration and shock absorption, vacuum management, precision movements, structure, etc.

COMPETENCIES & CAPABILITIES

- Engineering: design, development, justification
- Support engineering: demonstration of reliability and lifespan, development and qualification of industrial processes, etc.
- Manufacturing: CNC, spark-erosion, laser welding, electron beam welding, brazing, HIP (Hot Isostatic Pressing), thermal and surface treatment and extensive control means (classical and three-dimensional metrology, metallography, radiography and Tomography).
- Test & Qualification: dedicated test benches.
- Cleanliness management: clean rooms, laser assembly and welding, dust-free ("grey") rooms, electron beam assembly and welding.



ATMOSTAT

PRODUCTS & SERVICES

Design and manufacturing

- Valves and propulsion elements.
- Thermal components for cooling systems
- Tanks
- Cryostat
- Structures for different components
- Poppets
- Small electro-mechanisms

MAJOR SPACE PROJECTS & REFERENCES

Space projects:

- ExoMars Trace Gas Orbiter (400N valves for thruster)
- Communication satellites (1N / EVV valves for thruster and evacuation systems)
- LSO compatible tank (French Law on Spatial Operations)
- SVOM - ECLAIRs (coded-mask)
- Euclid (Titanium Baffle)
- PHARAO (caesium tank and caesium filling bench)
- ExoMars (deployable lightweight ribbon antenna : EISS)
- James Webb Space Telescope (Filter Wheel and box)

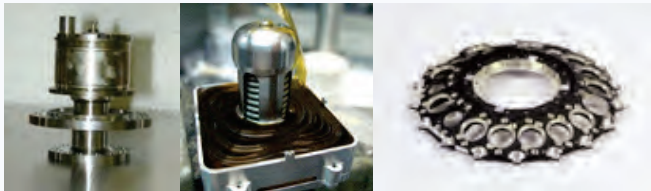

Customers:

- CNES, ARIANE, CNRS, CEA, THALES, AIRBUS, ...

POINT OF CONTACT

ADDRESS 31, rue René Hamon
94815 Villejuif Cedex
France

WEBSITE www.atmostat-alcen.com

PHONE +33 (0) 1 46 77 67 27

POINT-OF-CONTACT: VARGA, Florence, fvarga@atmostat-alcen.com

Phone number +33 (0)1 56 70 79 70

TURNOVER 12,5 (in M€)

WORK FORCE 107 employees

SPACE TURNOVER 700 k€

SPACE WORK FORCE 15

Orbital systems
Satellites
Ground segments
Transversal competencies



Atos is a global leader in digital transformation with approximately 100,000 employees in 72 countries and annual revenue of around €12 billion. The European number one in Big Data, Cybersecurity, High Performance Computing and Digital Workplace, The Group provides Cloud services, Infrastructure & Data Management, Business & Platform solutions, as well as transactional services through Worldline, the European leader in the payment industry.

COMPETENCIES & CAPABILITIES

Atos has demonstrated strong skills in key space areas with a wide range of capabilities and competencies. The company realises development, maintenance and support to operations activities for diverse ground mission and control centres. It is also a pioneer in the development of Earth Observation Data exploitation platforms.

Atos know-how encompasses the various technological requirements of software development and space engineering as innovation stands at the heart of its strengths with numerous R&T projects. Furthermore, the group has a unique expertise in hybrid cloud services, High Performance Computing (HPC) and cybersecurity including Security Operations Centres (SOC).



ATOS

PRODUCTS & SERVICES

Atos is actively involved in the space industry delivering adapted innovative technologies designed to its customers' specific needs.

Atos develops and maintains ground control and mission centres such as the ISIS product line program establishing new standards for ground control centres. SparkinData, based on Atos CODEX assets in cloud computing and Big Data analytics, is the operational platform developed for the exploitation of Earth Observation and geolocalised Data.

The company's broad portfolio covers space technologies such as critical software development for example in Space Situational Awareness (SSA) but also space engineering, satellite simulation benches or model based engineering thanks to its Method & Tools products. Moreover, Atos has a unique IT expertise in HPC through its Bullion offering, in SAP solutions, in mutualised SOC and in managed services and helpdesk.

MAJOR SPACE PROJECTS & REFERENCES

With a strong experience of more than twenty years in the domain of Space, Atos has demonstrated its ability to lead innovative large-scale space programs. Its technological knowledge is used on numerous projects. They include the maintenance in operational conditions of the CADMOS used by Thomas Pesquet for the Proxima program or specifications for mission centres like Microscope or SVOM. Proven skills in control centres enables Atos to develop the future product line ISIS for the CERES and Merlin missions.

PEPS, the platform exploiting Earth observation Data collected from the sentinel satellites in the CNES is also an Atos technology. The firm is involved in the space debris identification program.

POINT OF CONTACT

ADDRESS 6 impasse Alice Guy – BP 43045
F-31024 Toulouse Cedex 3 - France

WEBSITE <https://atos.net>

PHONE +33 (0)5 34 36 37 38

POINT-OF-CONTACT: Stéphane Chechin - Global Account Executive Space
stephane.chechin@atos.net +33 (0)6 88 05 68 00

TURNOVER €12B

WORK FORCE 100,000

SPACE TURNOVER €25m

SPACE WORK FORCE

Orbital systems
Ground segments
Satellites
Launchers



AUREA Technology provides high-performance optical instruments and modules for Space industry:

- Quantum Communications and Quantum Information,
- Laser communications,
- High-resolution LIDAR,
- High-resolution metrology for optical fibers.

COMPETENCIES & CAPABILITIES

AUREA Technology designs, develops, and manufactures high-performance optical instruments and modules based on the latest photonics technologies, including ultra-low-level-of-light photon counting detectors, high-brightness entangled photon sources, ultra-fast pulsed laser, and fast timing electronics.



AUREA TECHNOLOGY SAS

PRODUCTS & SERVICES

- Entangled Photon Sources at telecom wavelengths for satellites Quantum communications,
- Single Photon Counting detectors and optical receivers for Optical Ground Station,
- Laser communications at telecom wavelengths,
- Timing electronics,
- High-resolution LIDAR,
- High-resolution OTDR.

MAJOR SPACE PROJECTS & REFERENCES

HP-EPS project for SAGA ESA project:

design & development of a High-Performance Entangled Photon Source at telecom wavelength for Quantum communications.

TEQUANTS project for SAGA ESA project:

- design & development of ultra-low level-of-light and high-speed photon counting detectors at telecom wavelengths based on Single Photon Avalanche Photodiode technologies,
- design & development of a high brightness Entangled Photon Source at telecom wavelength.

POINT OF CONTACT

ADDRESS 18 rue Alain Savary
25000 Besançon, France

WEBSITE www.aureatechnology.com

POINT-OF-CONTACT : Dr. Emmanuel Fretel, Space Project Manager
sales@aureatechnology.com

Orbital systems
 Launchers
 Satellites
 Ground segments
 Balloons
 Transversal competencies



AVANTIS Group is specialized in the engineering development, manufacturing and assembly of flight platform, mechanical sub-system and MGSEs in the area of Space, Aerospace, Defense, Nuclear and transport.

- 11 sites and 1 R&D center in France
- 5.500 m² of manufacturing and assembly plant for flight parts and MGSEs
- 400 employees including 60% engineers

COMPETENCIES & CAPABILITIES

AVANTIS Group offers a global solution to take over projects from the specification until the integration:

- MGSEs (Mechanical Ground Support Equipments)
- Specific equipments, tools and machines for AIT centers
- Flight platform structures
- Flight sub-systems and mechanisms
- Flight Harness with our partner
- MLI, passive and active thermal control with our partner
- Capacity to perform assembly in ISO 8 or ISO 5 clean rooms with our partner

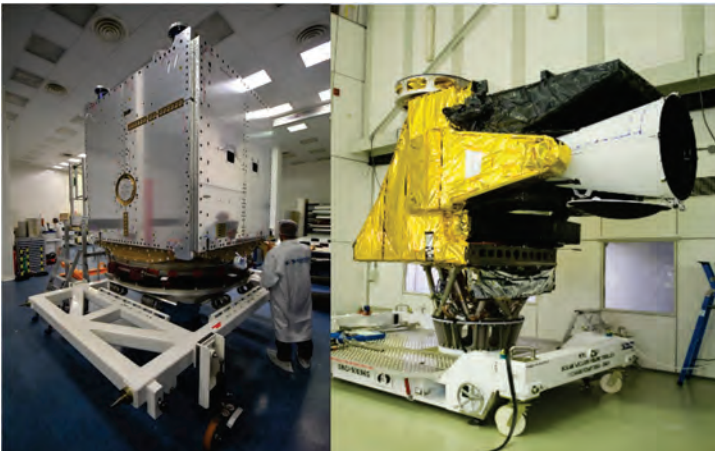

AVANTIS

PRODUCTS & SERVICES

Scope of activities:

- Customer requirements expertise
- Project management
- Research & Development
- Studies and definition
- Mechanical dimensioning and justification
- Documentation dedicated to space activities
- Industrialization
- Manufacturing and assembly
- 3D control
- Tests & qualifications
- Packaging
- National and International shipping
- Construction Yards
- On-site installation
- Preventive & curative maintenance operations

MAJOR SPACE PROJECTS & REFERENCES

Flight platform and sub-systems :

- The SWOT *platform for Thales Alenia Space and CNES*
- *Global Star 2 / O3B antennas and yokes for Thales Alenia Space*
- *Telescope demonstrator.*

MGSEs : More 380 MGSEs and tools delivered since 2005 for scientific and telecommunication satellites (multipurpose trolleys, assembly tools for AIT, optic tools, vibration frames, thermal and CATR test supports) for ESA, CNES, Thales, Airbus, OHB, MDA and Orbital.

Assembly tools and testing machines for launchers (Ariane Group)

POINT OF CONTACT

ADDRESS AVANTIS GROUP, 12 route de St Matthieu, 06130 Grasse France

WEBSITE www.avantis-group.com

PHONE +33 (0)4 97 01 09 90

POINT-OF-CONTACT : Alexandre ALATI, Design Office Manager
alexandre.alati@avantis-group.com, +33 (0)4 97 01 09 90

TURNOVER 31 M€

WORK FORCE 400

SPACE TURNOVER 8.5 M€

SPACE WORK FORCE 120

Satellites
Transversal competencies



Created in 1965, Axon' Cable is a French group specialized in the design and manufacture of cables and interconnect solutions for high tech applications. The range of products is very large: high performance wires, hybrid cables, cable assemblies, mini-systems, miniature connectors, metal-plastic components, and elastomer components. With over 2300 staff worldwide, the company is implanted in Europe, Asia and in America.

COMPETENCIES & CAPABILITIES

Involved in numerous space projects in orbit and beyond over 25 years, Axon' Cable has a wealth of experience in designing and manufacturing interconnect solutions able to withstand the stresses of launch and the harsh space environment.

Taking into account the NewSpace requirement, Axon' has developed adapted interconnect solutions and connectors.

The company is equipped with **ISO7 clean rooms** with very stable temperature and humidity control and the company has experience in working with planetary protection and bioburden requirements.

Axon's manufacturing harness capability consists of highly skilled and experienced operators accredited to **ESA and IPC standards**.

Our space team is able to support your space projects with all appropriate documentation.



AXON' CABLE

PRODUCTS & SERVICES

Axon' offers a complete service from the choice of material or components, to the design, routing, manufacturing, test and qualification of your products. 2D or 3D cabling boards can be developed to ensure perfect integration at customer's facilities.

Axon' can design the harness while working directly on a real scale mock-up provided by the customer.

The scope of products offered by the company is extensive:

- ESA connectors and wires for spacecraft cabling
- Cable assemblies and harnesses terminated with various connector styles.
- MIL-STD-1553 bus harnesses for data transmission
- High speed assemblies including SpaceWire and very high speed links up to 10 Gb/s
- Microwave coaxial cable assemblies up to 50 GHz
- Bus bars for power distribution in spacecraft
- Bespoke interconnect solutions

MAJOR SPACE PROJECTS & REFERENCES

Major space projects:

Rocket launchers, ISS, Mars rovers, LEO and GEO satellites, manned and unmanned flights, thrusters, space research and experimental equipment.

References:

Ariana, Alphaspace, Curiosity, Bepi Colombo, Eurostar, ExoMars, Insight, Maven, Mangalyaan, Sentinel, Vega, Solar Orbiter, Oneweb, etc.

POINT OF CONTACT

ADDRESS 2 route de Châlons en Champagne
51210 Montmirail - France

WEBSITE www.axon-cable.com

PHONE +33 (0)3 26 81 70 00

POINT-OF-CONTACT : Fournaise, Emilien Sales
e.fournaise@axon-cable.com, + 33 3 26 81 71 02

TURNOVER 157 M€ - consolidated

WORK FORCE 2360 employees worldwide

SPACE TURNOVER

SPACE WORK FORCE



Transversal competencies

Bertin Alpao, leader in wavefront control, aims to revolutionize optics by removing aberrations. The company designs and manufactures a complete range of adaptive optics products for use in research and industry since 2008. Bertin Alpao provides deformable mirrors, wavefront sensors and software.

Bertin Alpao is an international company with customers on four continents in over 20 countries, representing 90 percent of its turnover.

COMPETENCIES & CAPABILITIES

Bertin Alpao's products are tailor made for various applications such as astronomy, ophthalmology, microscopy, wireless optical communications and laser applications.

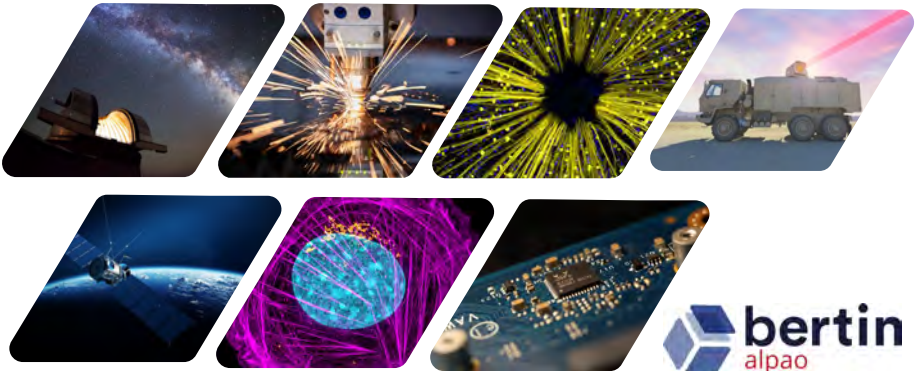

Bertin Alpao

PRODUCTS & SERVICES

Bertin Alpao has introduced several products over the years, such as deformable mirrors (DM), its own wavefront sensor for closed loop operations, the DM97-08 dedicated to vision science application, a large size DM (DMX) and a modal deformable mirror. Bertin Alpao also delivered the largest European deformable mirror which includes 3.228 actuators. With more than 10 years of experience in adaptive optics, Bertin Alpao's deformable mirror allow large stroke, fast deformation, high resolution images and very good optical quality.

MAJOR SPACE PROJECTS & REFERENCES

Academic references : Harvard university, Stanford University, University of Cambridge, MIT, University of California – Berkeley, Princeton University,...

Industrial and other references: Paris Observatory, Chara, ESO, Canon, Quantel Medical, Zeiss, Abbott Medical Optics, Onera,...

POINT OF CONTACT

ADDRESS 727 rue Aristide Berges
38330 Montbonnot - France

WEBSITE www.alpao.com

PHONE +33 (0)4 76 89 09 65

POINT-OF-CONTACT : Vincent TEMPELAERE, Directeur Général
contact@alpao.fr

TURNOVER

WORK FORCE ~47 employees

Orbital systems
Satellites
Ground segments
Transversal competencies



Innovation through research and development

We work on both research and development projects for our customers and on projects to develop our own product lines. We help customers in matching the right technological solutions to their needs, from research to the supply of equipment or solutions. To do this, we draw on the know-how of our various teams and our academic and industrial partners.

COMPETENCIES & CAPABILITIES

Technologies on demand

We develop unique, complex solutions in response to the specific needs of our customers: industrial conglomerates, public sector, start-ups and SMEs. With their expertise in leading-edge technology and their ability to operate in project mode, our engineers accelerate innovation in markets with high added value: nuclear, space, major scientific equipment, defense, life sciences.

For space, we are specialized in Optics, opti-mechanics systems development and manufacturing using ISO 5 Clean Rooms.

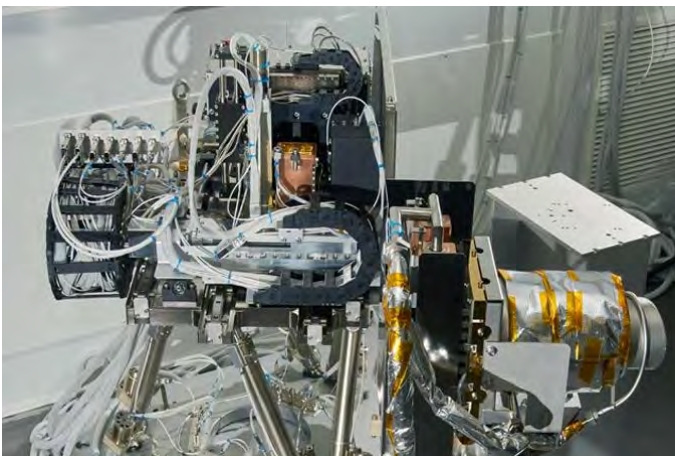

BERTIN TECHNOLOGIES

PRODUCTS & SERVICES

We develop ground test equipment (OGSE/MGSE) for satellite applications. These optical and mechanical test benches are fully designed and developed to conduct Assembly, Integration, Testing and Validation (AITV) phases. They are used to test, qualify, and validate instruments such as very high-resolution imagers, radar sonars or advanced telescopes.

We design and manufacture systems or subsystems that are sent into space. These instruments or pieces of optical, opto-mechanical and electronic instruments are fully developed up to the assembly, integration, testing and validation phases on behalf of major space contractors. As earth observation, scientific and defense missions depend on the spacecraft's proper functioning, Bertin and Winlight teams use state-of-the-art technologies to achieve the expected performances. Our teams make a point in fulfilling the very high stability, reliability, cleanliness and quality assurance requirements of that equipment.

MAJOR SPACE PROJECTS & REFERENCES

- CSO – MUSIS (TAS): OGSE & MGSE
- TARANIS (CNES): Photometer & GSE
- ATLID (ADS): 3 optical subsystems for the LIDAR Instrument
- MTG (TAS): 5 OGSE
- ENMAP (OHB) : OGSE
- IASI NG (ADS) : 2 optical systems & 1 OGSE

POINT OF CONTACT

ADDRESS 155 rue Louis Armand – CS 30 495 – 13 593 Aix en Provence
Cedex 3

WEBSITE www.bertin.fr

PHONE +33 (0)4 42 60 46 00

POINT-OF-CONTACT : HAUMONTÉ, Jean-Baptiste, Sales Manager
haumonte@bertin.fr , +33 (0)4 42 60 46 05

TURNOVER 100 M€

WORK FORCE 480 employees

SPACE TURNOVER 5 - 10 M€

SPACE WORK FORCE 80 employees

Launchers
Satellites
Transversal competencies



BLACKLEAF is the French graphene leader for industrial technological applications.

BLACKLEAF's graphene is disruptive, we answer to the 3 majors challenges of graphene industry: volume, quality and cost/price through an affordable and eco-friendly process of production.

Blackleaf aims to make graphene a strategic input to the widest range of industrial sectors to bring innovation, disruption and competitiveness.

We define **our mission** as: "supporting the ecological transition and the decarbonation of the industry".

COMPETENCIES & CAPABILITIES

Our tech is based on **10 years of Research and works** on graphene at an academic level (CNRS).

BLACKLEAF produces graphene and assists its customers in the implementation of our "game changer" graphene to address their high-tech applications, and thus achieve **fast ROI**.

Our innovative graphene is implemented in two ways: **100% graphene coating** on all types of surfaces (patented solutions) or **in dispersion in any matrix**.

In any case, we developed a knowledgeable expertise to bring support to the industry to make the graphene compatible with its application.



BLACKLEAF

PRODUCTS & SERVICES

Blackleaf produce pure few-layers graphene (FLG) in aqueous media.

Our products and the applications that we developed exploit a wide range of our graphene's properties:

- Electrical and thermal conductivity/dissipation
- Enhancement of mechanical properties (light, flexible, UTS, Young modulus)
- Chemical barrier effect, bactericide, impermeability (fire retardant, gas and water vapor, etc.)
- Lubrication (tribology of oils and greases, drag effect improvement)

Our graphene can be produced and delivered at different level of concentration in water-based solutions.

We also offer engineering services for the implementation of graphene in tailor-made applications.

We also propose graphene based products such as heat transfer fluids, low energy heating solutions, thermal interface material, lubricants...

MAJOR SPACE PROJECTS & REFERENCES

Contracts with some of the major French space industry players
CNES R&T, THALES.

POINT OF CONTACT

ADDRESS Parc d'Innovation 210, rue Geiler de Kaysersberg
67400 Illkirch-Graffenstaden - France

WEBSITE www.blackleaf.fr

PHONE see below

POINT-OF-CONTACT:

Yannick LAFUE, CEO, contact@blackleaf.fr, phone: +33(0)616.931.652

Thierry SOUILLART Sr Sales, tsouillart@blackleaf.fr, phone. +33(0)647.34.778

TURNOVER confidential

WORK FORCE 13 employees

SPACE TURNOVER confidential

SPACE WORK FORCE 5 employees

Satellites
Transversal competencies



Founded in 2013, Cailabs is a French deep tech company which designs, manufactures and distributes innovative photonic products for telecommunications, free space transmission, industrial lasers, and LANs. A global leader in complex light shaping, its technology is currently protected by 19 patent families.

Cailabs has developed the TILBA product range designed for improving the reliability of laser communications.

COMPETENCIES & CAPABILITIES

- Improve the reliability of satellite, naval, aeronautical (aircraft, drones) and ground free-space optical links, even in strong atmospheric turbulence
- Make optical communication accessible and easily deployable thanks to standard, easy-to-use embedded components.
- Design and manufacture key laser communication components and modules
- Support lasercom projects at different integration stages



CAILABS

PRODUCTS & SERVICES

With its TILBA product range, Cailabs offers components and modules designed to upgrade free-space optical communication ground terminals, and is able to support customers at different integration stages, from the component to the optical ground station

- TILBA-ATMO is the first fully integrated atmospheric turbulence correction module for optical satcom downlinks, compatible with standard telescopes and telecom architectures.
- TILBA-EMIT combines laser sources to increase uplink emission power.

The TILBA technology is also able to compensate fine pointing errors in inter-satellite links.

MAJOR SPACE PROJECTS & REFERENCES

Cailabs is involved in government, defense and commercial programs internationally, and collaborates with major companies, institutes and space agencies worldwide.

Most space projects are confidential but among the references Cailabs is working with:

- CNES and ONERA, particularly through a R&T action aiming at improving the reliability of space-based laser communications through atmospheric turbulence
- DLR
- BridgeComm

POINT OF CONTACT

ADDRESS 38 boulevard Albert 1er
35200 Rennes, France

WEBSITE www.cailabs.com

POINT-OF-CONTACT : Jacques-Sermet, Olivier
Business Development Manager Laser Communication
Olivier.jacques-sermet@cailabs.com
+33 (0) 6 47 75 69 92

TURNOVER N/A

WORK FORCE 60 employees

SPACE TURNOVER N/A

SPACE WORK FORCE 10 employees

Ground segments
Transversal competencies

Callisto

Callisto was founded in 1993 by Steve Rawson. Over this time, our company has undertaken a wide range of engineering consulting projects, building a reputation as a highly skilled partner to satellite operators, integrators and equipment manufacturers. Since 2018, we are part of Celestia Technologies Group, thus widening our capabilities.

COMPETENCIES & CAPABILITIES

Callisto designs, manufactures and markets high performance Low Noise Amplifiers (LNAs) with associated hardware and software to cope with G/T Ground Stations challenges. Thanks to our expertise in Radio Frequencies and Cryogenic Systems, we also provide a set of services, particularly for ESA such as consultancy, engineering services, equipment design, system integration and thermal cycling test.

Callisto is located near Toulouse, France where we have laboratories equipped with radiofrequency instruments and cryogenic test facilities.

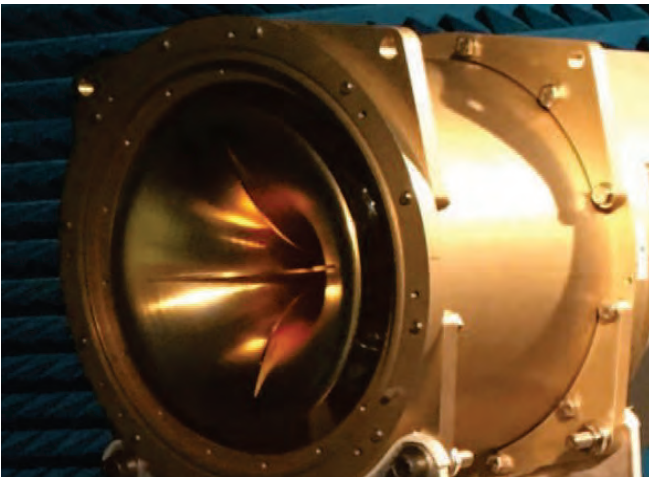

CALLISTO FRANCE SAS

PRODUCTS & SERVICES

Callisto is a leading supplier for Deep Space communications (i.e space-exploration missions to the planets), Earth Observation, VLBI, Radio Astronomy & Satcoms.

Callisto develops ambient Low Noise Amplifiers (LNAs) and Ultra-low noise performance by cryo-cooling the electronic RF components of the amplifier circuits. This ultra-low noise technology originally developed by our company for ESA Deep Space applications, reinforces the value chain for other applications such as Earth Observation where the benefit is a reduction in the size and costs of ground antennas. Callisto's unique zero maintenance cryogenic LNA reduce operational costs compared to traditional cryo-systems.

Callisto offers services such as Ground Station Engineering, consultancy engineering services, equipment design, integration and Cryogenic thermal cycling test from 15K to 333K.

MAJOR SPACE PROJECTS & REFERENCES

Here are our major space projects:

- Study on the use of 25.5-27GHz Band in ESA ground stations.
- Future Architecture of ESA Deep Space Stations.
- Study on Future Multiple Uplink per Aperture Access Scheme.
- Orbit to Ground Propagation Measurements to De-Risk Future EO Missions.

Our clients (such as CNES, ESA, ISRO, Thales Alenia Space, Eumetsat, Safran, Inmarsat, Sofradir, Airbus D&S, Vertex, MT Mechatronics) enjoy a totally dedicated service, with flexibility to meet the client's requirements. Callisto is a company recognized and listed as an SME by the European Space Agency.

POINT OF CONTACT

ADDRESS 12 avenue de Borde Blanche
F-31290 - Villefranche-de-Lauragais - France

WEBSITE www.callisto-space.com

PHONE +33 561 800 807

POINT-OF-CONTACT: sales@callisto-space.com

TURNOVER > €1,5m (2019)

WORK FORCE 12 (2019)

SPACE TURNOVER €1,5m (2019)

SPACE WORK FORCE 12 (2019)

Launchers
Satellites
Ground segments
Transversal competencies



As a global leader in consulting, technology services and digital transformation, Capgemini is at the forefront of innovation to address the entire breadth of clients' opportunities in the evolving world of cloud, digital and platforms. Building on its strong 40-years specific expertises in the Space sector which cover the entire value chain, Capgemini is an enabler for the European space ecosystem to make real their ambitions through a wide panel of services from strategy to operations

COMPETENCIES & CAPABILITIES

Supported by 600 experts located in Toulouse, our services address the actual challenges faced by the space core business, working alongside with European space key players and by users of space applications.

Our competencies set covers IT integrator core skills on space ground system, engineering, cloud, data analytics, science, GNSS systems manufacturing, artificial intelligence, cybersecurity and GDPR compliance.

Capgemini is proud of a +40 years proven track record in Space activities in Earth Observation, Telecom, Navigation and Science programs.



CAPGEMINI

PRODUCTS & SERVICES

Capgemini provides a wide range of skills from technical levels to functional expertise to define the operational efficiency of a common development process and the related development environment. Owning a global understanding from algorithm specification to implementation, Capgemini achieves to match the best architecture with the required scientific objectives.

SPACE NAVIGATION / GNSS: Manufactured equipment included in GNSS program Ground Segment

DIGITAL MANUFACTURING: IoT/ Connectivity, Digital Twin, M-AIT Expertise and Tools development

CRITICAL & COMPLEX SEGMENT: Mission & Control centers, critical ground segment element, Search and Rescue Ground Segment

DIGITAL PLATFORM & TOOLS: Data Exploration & Analytics platform, data fusion of multi sources of data, Digital climate platform, processing chains, scientific expertise

IN ORBIT SERVICES: on-board processing, in-orbit services, MBSE, AR/VR, system simulation and modeling.

MAJOR SPACE PROJECTS & REFERENCES

For the development of Earth Observation missions, Capgemini is involved in the design of ground segment ([MICROCARB](#)), in the processing chains ([MICROCARB](#) and [SMOS](#), [CFOSAT](#)), processors design and development ([SWOT](#)), integration of operation chains ([MUSCATE](#), [PEPS](#)). For Telecom and GNSS domains [Satellites](#) on the Development of Manufacturing Intelligence Tool for Space industrial process optimization using cloud platform and [EGNOS](#) and [Galileo Design, Development and long-term maintenance](#). Additional references are the [MAAP](#) ESA-NASA Multi Mission Algorithm Analysis Platform dedicated to scientific community exploring Biomass mission and [SSALTO](#) for the ground segment of altimetry from multi-satellites. For the Martian missions ([Curiosity](#), [InSight](#), [MARS2020](#)) where Capgemini has developed mission centres and expertise centres of French instruments.

POINT OF CONTACT

ADDRESS 106 Avenue du Général Eisenhower
BP 53655 - 31036 Toulouse Cedex 1

WEBSITE www.capgemini.com

PHONE +33 (0)6 87 86 16 62

POINT-OF-CONTACT: Marc Ferrer, Head of Space & ATM market segment
marc.ferrer@capgemini.com

TURNOVER 14 B€

WORK FORCE 219 000 employees

SPACE TURNOVER 70 M€

SPACE WORK FORCE 600 employees

Satellites
Transversal competencies



CEDRAT TECHNOLOGIES (CTEC) is a SME specialized in the design, qualification and manufacturing of flight mechatronics and mechanisms for Space, Defense & Optic Instruments.

CTEC takes benefit from its own proprietary space qualified technologies, in the field of magnetic & piezoelectric actuators, sensors & electronics, to provide reliable and high performance mechatronic solutions for static & dynamic control of structure, optic & fluid.

COMPETENCIES & CAPABILITIES

CTEC is expert in the domain of embedded actuators, sensors & mechanisms, with associated electronics. CTEC is able to develop dedicated solutions accounting for operational & environment specs (shock & vibration).

Its knowhow includes expertise in piezoelectric & magnetic materials, long lifetime frictionless mechanics, (flexure bearings & hinges), high precision sensors, tribology (piezo motors friction interface), cleanliness, drive & sensing electronics. CTEC building blocks and CAD & tests facilities (interferometers, cryo, TV, clean room ...) allow to develop many precision functions: micro or nano static & dynamic multi-degrees of freedom positioning, scanning, fluid control.

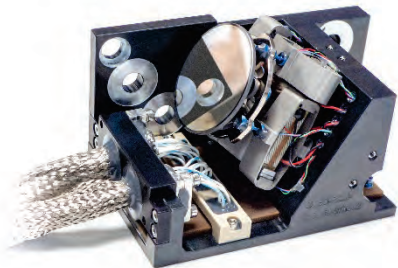

CEDRAT TECHNOLOGIES

PRODUCTS & SERVICES

CEDRAT TECHNOLOGIES designs, manufactures, and qualifies, flight space solutions on demand including:

- Piezo actuators, especially Amplified Piezo Actuators APA®
- Piezo Motors, such as Stepping Piezo Actuators SPA & FSPA
- Magnetic actuators, such as Solenoids, Voice Coils & MICA™
- Position sensors, such as Strain Gage & Eddy Current Sensors
- Short & Long stroke linear, rotating or multi-dof mechanisms
- Fine or fast Steering Mirrors (FSM) based on Tip Tilts (DTT)

Hold Down & Release Mechanisms (HDRM), as BRUCE

- Valves, pressure regulators, compressor active parts
- Development services under Product Quality assurance include:
- Design justification, FEA, CAD, FMECA
- Precision assembly, metrology, clean room (up to ISO 4)
- Tests: stability (up to 1 nm), vibration & shock, thermal & vacuum (TV), cryogenic (< 30K), lifetime tests.

MAJOR SPACE PROJECTS & REFERENCES

- APA®-based mechanisms from CTEC have flown on past programs such as ROSETTA/MIDAS, ISS/PHARAO, LISA PATH FINDER /OPDA, ATLID/BSA. Customized FSPA piezo electric motors are selected for IASING /BSMA.
- Linear & Rotating Voice Coil Motors, HDRM BRUCE, Eddy Current Sensors ECS are soon to be flown on MTG/FCI/IRS, MTG/SCA, TARANIS, EUCLID/NISP.
- Moving Iron Controllable Actuators MICA™ have been selected in R&T programs for cryocoolers and liquefiers compressors.

POINT OF CONTACT

ADDRESS 59 Chemin du Vieux Chêne,
Inovallée, F-38246 – Meylan
Cedex - France

WEBSITE www.cedrat-technologies.com

PHONE +33 (0)4 58 56 04 00

POINT-OF-CONTACT: actuator@cedrat-tec.com

TURNOVER €6m

WORK FORCE 55

SPACE TURNOVER €1,8m

SPACE WORK FORCE 10

Satellites
 Ground segments
 Launchers
 Transversal competencies



- ✓ Cerfacs is a centre of research, development, transfer and training regarding simulation and High Performance Computing (HPC) in priority for the benefit of its industrial and public shareholders
- ✓ Cerfacs provides numerical simulation methods and tools to invent and design innovative products
- ✓ Cerfacs offers high-level training

COMPETENCIES & CAPABILITIES

Cerfacs designs and develops innovative methods and software solutions to meet the needs of space sector: to simulate very complex phenomena in order for instance:

- to improve the design of launchers engines,
- and with satellite data to better understand the nature of climate fluctuations and to better assess the impact of natural hazards (such as floods or forest fires).

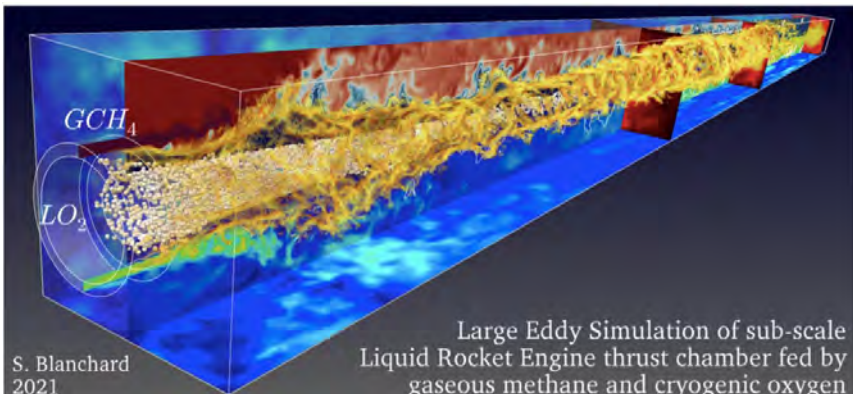

S. Blanchard
 2021

Large Eddy Simulation of sub-scale
 Liquid Rocket Engine thrust chamber fed by
 gaseous methane and cryogenic oxygen

CERFACS

PRODUCTS & SERVICES

Cerfacs provides expertise, software and engineering services for High performance Computing and Exascale Computing, Linear Algebra and Optimization, Coupling, Numerical methods for PDE, Data Driven Modelling (Uncertainty Quantification, Data Assimilation, Data Science & Machine/Deep Learning).

MAJOR SPACE PROJECTS & REFERENCES

- ArianeGroup
- Airbus
- CNES
- ESA
- COMAT

POINT OF CONTACT

ADDRESS 42 av. Gaspard Coriolis 31057 Toulouse Cedex 1
France

WEBSITE www.cerfacs.fr

PHONE +33 (0)5 61 19 30 01

POINT-OF-CONTACT : LAMBERT Catherine, President
catherine.lambert@cerfacs.fr, +33(0)6 60 22 95 51

TURNOVER 8 M€

WORK FORCE 110 employees

SPACE TURNOVER 2 M€

SPACE WORK FORCE 20 employees

- Orbital systems
- Launchers
- Satellites
- Ground segments
- Balloons
- Transversal competencies



CES Works Group is specialized in disruptive innovation (TRL 1 to 5, functionalized structures, complex systems). We think outside the box to meet our subsidiaries and our clients' needs in the space, aeronautics, military, railway and scientific sectors.

Our subsidiary *CES Services* offers expertise in the field of breakthrough innovation, particularly in design, calculation, instrumentation, testing, repair and associated economic aspects.

COMPETENCIES & CAPABILITIES

We work as well in the field of launchers (from micro to heavy) as in the field of space vehicles (including new space). We are specialized in:

- Structure optimization and instrumentation (metallic, composite, multi-material),
- Thin (0.2mm) to thick structures (200mm),
- Functionalized structures (E.M.I., radiation, specific needs, embedded electronics...),
- Compliant mechanisms and deployable structures,
- Space manufacturing,
- Associated control command system.

EXPERTISE

DEVELOPMENT

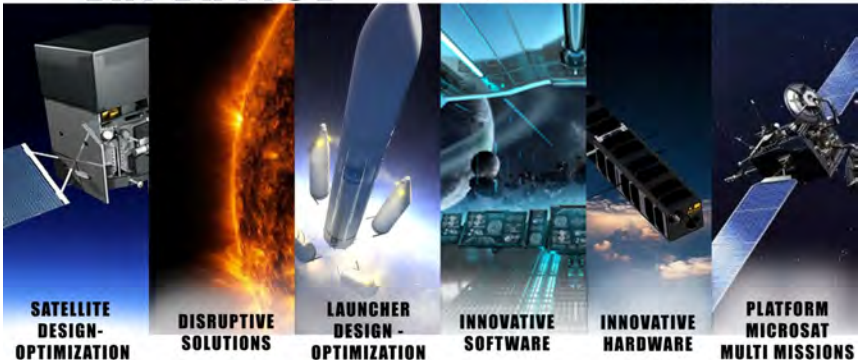

CES WORKS

PRODUCTS & SERVICES

Services and expertise:

- Design and characterization of materials and structures (TD and TP composites, elastomers, shape memory alloys, auxetic materials, ...).
- Digital twins' development.
- Implementation and operation (very low / high temperature, detonation, radiation) of in-house and off-the-shelf sensors (fiber optic Bragg gratings, Piezo sensors (process monitoring, behavior monitoring), Mems sensors ...);
- Definition of instrumentation strategies (multi-scale) from design to use;

Products:

- Embedded and multifunction AI
- Multi-mission System management
- Lego approach Plug & play
- Optimized Tracking system

MAJOR SPACE PROJECTS & REFERENCES

* Our collaboration: Airbus D&S, ESA, CNES, CNIM, Thales Alenia Space... for example:

- We worked with IN2P3 and LLR on the structure of the Glast Fermi Calorimeter (study on gamma radiation). We worked on the design, optimization, process/material links, mechanical and thermal modeling, and certification.

* I-NOV6 COMPETITION (2020): we have been selected to develop 2 core technologies of a space project (multi-mission management board and Plug & Play interface).

* CNES R&D Challenge (April 2021): winners of the CNES R&D challenge on upper stage reuse.

POINT OF CONTACT

ADDRESS 131, Traverse de La Penne aux Camoins - BT 4 - Actiparc 1
13821 La Penne Sur Huveaune, France

WEBSITE www.composites-expertise-solutions.com/

PHONE +33 (0)7 66 89 97 58

POINT-OF-CONTACT: Meltzheim Anouk - Business Developer,
Anouk.meltzheim@ces-works.com

TURNOVER /

WORK FORCE 9 employees

SPACE TURNOVER /

Orbital systems
Launchers
Satellites
Ground segments
Transversal competencies



CGI supports space clients across **Europe, Australia, Asia and North America**. Our first space project was in **1974** and we have continued to grow our presence in the space sector. We work to increase the value of our clients' space investments while combatting ever-growing security threats to space assets and information.

COMPETENCIES & CAPABILITIES

At CGI, we deliver secure, mission-critical space systems to commercial and government organizations looking to accelerate their digital transformation. Since completing our first space project in 1974, we have developed **advanced systems and software for government, military, scientific, academic and commercial space initiatives**. We supported the missions of more than **1 000 space satellites** and our **2 500 experts** in space and related industries help our clients build strategies and solutions that achieve tangible outcomes. Increasingly, space data-enabled solutions are part of daily life. Location-based services, weather forecasting and navigation systems, available on almost every mobile device, are just a few examples. The opportunities to use space data to help government and industry address key challenges such as climate change, environmental sustainability and net-zero continue to expand, along with evolving security and privacy requirements. Our capabilities in **Earth observation, satellite communications, satellite navigation, satellite operations, space applications** and **space cybersecurity** include **data processing** and **exploitation, robotics, command and control, on-board software, modeling** and **simulations, ground segment engineering**, and **situational awareness**.



PRODUCTS & SERVICES

We develop and implement secure, cutting-edge space systems:

- **Monitor and control systems** - technology that reliably and cost-effectively manages space assets.
- **Satellite applications and services** - that extract information from satellite data, including weather, navigation, telecommunication and geographical survey data.
- **Business management systems** - enterprise applications enable space companies to run their businesses.
- **Telecoms and broadcasting systems** - we have developed some of the world's most advanced systems for satellite network and service management, billing, messaging and subscriber management.
- **Ground segment prime contractor** - the ground infrastructure of space programmes has complex software-intensive systems which we design and manage, ensuring deployment on time and to budget.

MAJOR SPACE PROJECTS & REFERENCES

Our client list is a Who's Who of the European space industry, including the **European Commission, Space Agencies, Eumetsat, Eutelsat, Inmarsat, SES, Airbus Defence & Space** and **Thales Alenia Space**. Our in-depth space sector knowledge and our contribution to major technical advances ensure that we contribute to many of the world's most prestigious space programmes, including **Cassini-Huygens, Galileo, Egnos, Copernicus, Inmarsat 4, MSG, MTG, MTSAT, Rosetta, Skynet5** and **XMM-Newton**. For example, we:

- Delivered the Galileo satellite constellation control facility that will control all Galileo's 30 satellites – Europe's strategically important satellite navigation system
- Provided the flight software for the Huygens probe which successfully landed on Titan, Saturn's largest moon.
- Delivered systems that produce weather satellite images and data for Europe, Africa, the Pacific and the Indian Oceans, covering a population of over 3 billion people.
- Supply systems that validate GPS navigation messages, ensuring their safe use by the aviation industry.

POINT OF CONTACT

ADDRESS 15 avenue du Docteur Grynfoegel
31100 Toulouse, France

WEBSITE www.cgi.com/en/space

PHONE +33 (0)5 67 69 22 22

POINT-OF-CONTACT : KNECHT, Alexis | Directeur Conseils-Services
alexis.knecht@cgi.com

TURNOVER 8 760 M€

WORK FORCE 91 500

SPACE TURNOVER 200 M€

SPACE WORK FORCE 2 500

Orbital systems
Launchers
Satellites
Ground segments
Balloons
Transversal competencies



Group ACB is a Printed Circuit Board manufacturer, we have three factories working on the high technology and high reliability sectors including Space and New Space industry.

We offer Quick Turn Around production and standard leadtime in small or medium quantity.

Our factory Atlantec is specialist in high frequency application such as antenna, radar applications, Flexible, Flex-rigid PCB and others for high reliability applications

COMPETENCIES & CAPABILITIES

Group ACB – CIBEL factory is working for several small sat, cube sat, nano sat and constellation. PCB for calculation unit, power conversion and other electronics applications used in space and new space equipment's. We work from the early steps of the project offering mock-up manufacturing up to ESA qualified space model (can be in Group ACB other factory withing a ESA PID). We are dedicated to the production in quick turn around in few working days to supports you on the early steps of your projects

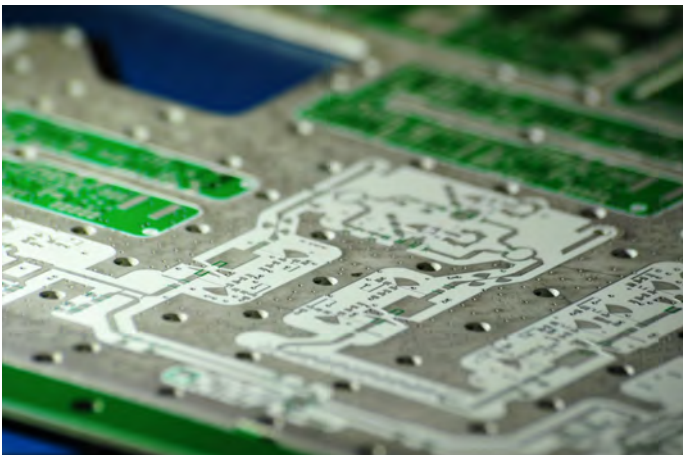

ACB - CIBEL

PRODUCTS & SERVICES

Manufacturing of your PCB:

- Rigid
- Sequential Rigid
- HDI Rigid
- Flexible
- Flexible-Rigid
- Flexible-Rigid HDI
- IMS
- CIC
- Special thermal management solutions
- High frequency (several materials including PTFE, ETFE, Hydrocarbon-Ceramic, PPE/MPPE...)
- Specials

MAJOR SPACE PROJECTS & REFERENCES

ESA Heritage within the group ACB on several Satellites program from 2016 (sentinelle, Galileo, Proba...).

POINT OF CONTACT

ADDRESS ZI Rue des CYTISES
61130 BELLEME France

WEBSITE www.acb.be

PHONE +33 (0)6 74 59 03 63

POINT-OF-CONTACT : Kevin TASTETS, Group Sales Director
ket@acb.be +33674590363

TURNOVER 7,5 M€

WORK FORCE 65

SPACE TURNOVER 0,8 M€

SPACE WORK FORCE 5

Satellites
Transversal competencies



For over 50 years, the company CILAS, subsidiary of HMS Laser and LUMIBIRD, has developed recognized expertise in laser and optical technologies.

Today, CILAS develops, industrializes and markets a wide range of products and systems using these high technologies.

Defense, security and civil devices, scientific and industrial instrumentation, cutting-edge optical components and major scientific laser programs are its main markets.

COMPETENCIES & CAPABILITIES

With half of its turnover being generated by direct exports, CILAS is furthering its international development while continuing to develop and improve the latest technologies for future products designed to meet emerging needs.

Among CILAS flagship products, we find space qualified optical components and coatings, optical amplifiers for space communication and deformable mirrors for space applications.



CILAS

PRODUCTS & SERVICES

1) Solid state and fiber lasers and amplifiers:

CILAS designs and manufactures compact pulsed solid state lasers, fiber based lasers and amplifiers dedicated respectively to high pulsed energy and power applications including LEO/GEO optical links

2) Space borne deformable mirrors:

CILAS piezoelectric Monomorph technology is compatible with space borne instrumentation requirements.

3) Optical components and coatings:

CILAS manufactures filters, stripe filters, dichroic, polarizers, anti-reflection coatings, absorbing coatings, protected or enhanced metallic coatings, all qualified to space environment.

Production means allow large size coatings up to 2mx2m size.

MAJOR SPACE PROJECTS & REFERENCES

1) Solid state and fiber lasers and amplifiers:

CILAS is developing a 10W amplifier module for space optical communication with CNES and a 400mJ amplifier for space instrumentation with ESA.

2) Space borne deformable mirrors:

CILAS OTOS-TANGO Space borne deformable mirror has been validated TRL 6 by Airbus Defense and Space and CNES.

3) Optical components and coatings:

CILAS supplied optical components for LOLA, GOCI, Taranis, Tropomi, Sentinel 5, Proba V, Proba V-EVO, Chemcam, Supercam, Metimage, Microcarb, LSTM...

POINT OF CONTACT

ADDRESS 8 avenue Buffon 45100 Orleans - France

WEBSITE www.cilas.com

PHONE +33 (0)2 38 64 15 55

POINT-OF-CONTACT: optics@cilas.com

TURNOVER M€ 45

WORK FORCE 270

SPACE TURNOVER M€ 2.5

SPACE WORK FORCE 5 %

Ground segments
 Balloons
 Transversal competencies



Design office in embedded technologies, electronic design, and software.

COMPETENCIES & CAPABILITIES

- **Embedded Hardware (Electronics):** design, validation, integration, and industrialization – 3 engineers
- **Embedded Software:** FPGA, low level, Bare Metal, application, OS (Linux), RTOS (FreeRTOS, QNX, VxWorks), HMI (QT, PcVue) – 7 engineers
- **Embedded System:** co-design and small and medium series production



CIO SYSTEMES EMBARQUES

PRODUCTS & SERVICES

Embedded system realization

- Digital mirror (automotive)
- Penetrometer (industry)
- In-flight entertainment (aeronautical)
- Endoscope (industry)
- Video recorder

Expertise:

- RTOS, LINUX / YOCTO,
- safety, cybersecurity,
- signal processing, image processing, video stream management,
- C / C ++ development and FPGA development.

MAJOR SPACE PROJECTS & REFERENCES

CNES Balloons (since 2006):

- **NPT - Flight software development:**
Platform: OBC - CNES generic module (ARM)
Features : GPS - Fine pointing - Azimuth pointing - IMU - ...
- **BSO/BPS – Ground station**
Platform: PC operator
Features: Remote control telemetry processing
- **Communication and localization system**
Platform: CNES generic module (ARM)
Features: Remote control telemetry processing

POINT OF CONTACT

ADDRESS 1 rue de la presse
42000 Saint-Etienne France

WEBSITE www.ciose.fr

PHONE +33 (0)4 77 93 34 32

POINT-OF-CONTACT : Thonnerieux Rémi, sales manager
remi.thonnerieux@cirose.fr

TURNOVER 1,4 M€

WORK FORCE 13 employees

SPACE TURNOVER 0,4 M€

SPACE WORK FORCE 5 employees

Transversal competencies



Study and Realisations of Bonding Services: We carry out studies of your bonding assemblies. We then execute these assemblies in our plant specially equipped for bonding techniques.

CLIX Industries has also developed products like self-deploying systems and other applications for the space industry. Many of them have been done in collaboration with the CNES or with other major players of this sector.

COMPETENCIES & CAPABILITIES

CLIX Industries is specialized in developing bonding systems. We have our own R&D department, we run researches in bonding technics, materials and bonded assembly simulations (Abaqus). We engineer complete assemblies: CAD, bonding material definition, thermal and mechanical behavior, industrialization and validation.

For manufacturing our company is equipped with white rooms, robot units, and dispensing tables.

We cover the production of EM, QM and FM.



CLIX Industries

PRODUCTS & SERVICES

Self-deploying structures: CLIX composite Hinge and Mast are based on elastic composite parts and flexible membranes. They provide a spring function for self-deployment and locks itself in the open end-position. We also propose the Hold Down and Release Mechanisms adapted to these solutions.

Flexible Pivot: Mechanism based on orthogonal blades deformation around a virtual rotation axis. It is friction free and there is no need for lubrication. Our production process gives a great design freedom and material choice for the blades and the pivot body.

Magnetic laminar stack for Stator, Rotor or any other stack applications: The bonded magnetic laminar stack proposes a full insulation between every single sheet with around 5µm bonding material thickness. This process decreases Eddy currents, Joule effects and iron losses for electrical stator/rotor. Structural bonding allows high resistance strength of magnetic stacks and higher electromagnetic performances.

All these developments have been made in collaboration with the CNES

MAJOR SPACE PROJECTS & REFERENCES

- Magnetic laminar stacks are flying since 2006 on a military space equipment.
- CLIX Hinges and HDRM are flying since 2019 on Eyesat nanosatellite.
- The other products are in qualification phase.

POINT OF CONTACT

ADDRESS 2-3 Allée de Longuetterre
31850 MONTRABE France

WEBSITE www.clix-industries.com

PHONE +33 (0) 5 61 736 889

POINT-OF-CONTACT : BOUDINOT, Richard, CEO, Richard.boudinot@clix-industries.com, +33 (0)5 61 736 889

TURNOVER 1,5 M€

WORK FORCE 12 employees

SPACE TURNOVER 0,2 M€

SPACE WORK FORCE --

Ground segments
Satellites
Transversal competencies



CLS is a global company and pioneer provider of monitoring and surveillance solutions for the Earth, created in 1986. CLS is a subsidiary of CNES and CNP. Its mission is to create innovative space-based solutions to understand and protect our planet and to manage its resources sustainably. CLS employs more than 750 people in 26 sites around the world. The company works in five strategic markets: sustainable fisheries management, climate & environmental monitoring, maritime surveillance, fleet management, and energy & mining.

COMPETENCIES & CAPABILITIES

CLS provides administrations, institutions, teams of scientists, private companies, with a wide range of services and solutions to assist decision making based on a unique combination of remote satellite data, in situ data, drones, and modelling data as well as our employees expertise. CLS delivers high value-added applications, services, expertise & recommendations, forecasting models, equipment and infrastructure. Its missions: help its customers understand the past, observe the present, prepare for the future, adapt to meet climate environmental challenges, assess the environmental impact of industrial and economic activities. CLS operates a 24/7 operation and data center fully resilient (900 servers, 150 products, 99,98% SLA, +100 processing chains, 1200 services daily delivered).



PRODUCTS & SERVICES

Environment & Climate Monitoring: Solutions to study, understand & assess Climate change and its impacts. From the ocean to the coast, CLS proposes solutions in in-situ & space oceanography, coastal management. CLS accompanies its clients in their management of water resources and the associated risks.

Sustainable fisheries management: CLS helps fishery stakeholders to sustainably manage their fisheries, connect, protect & empowered traditional and industrial fisheries through VMS, ERS & EMS solutions while optimizing & securing operations at sea.

Maritime surveillance: Complete, global view of what is happening at sea (area surveillance, sea rescue, optimize shipping fleets, fight against pollutions & trafficking). Global maritime traffic is monitored from CLS with multisource data management solutions.

Energy & mining: Solutions for securing and optimizing production of oil, gas, renewable energy, mining and monitoring of buildings and infrastructure with minimal impact on the environment.

Fleet Management: much more than a positioning service, CLS adds value to data by turning it into useful business information. CLS connects, locates and optimize fleets for waste management, humanitarian vehicles, and logistics.

MAJOR SPACE PROJECTS & REFERENCES

Environment & Climate Monitoring: +12 000 environmental satellite platforms tracked, hundreds of studies delivered for the major scientific, oceanographic, climate, space & meteorological programs & institutions (NOAA, EUMETSAT, ESA, CSIRO, ECMWF, etc.) **Sustainable fisheries management:** +30 Fishing Monitoring Centers equipped in the world, + 15 000 fishing vessel tracked each month, thousands of customers in more than 100 countries. **Maritime surveillance:** CLS analysts & means involved in Cleanseanet, European satellite-based oil spill and vessel detection service, all global maritime traffic monitored from CLS, CLS's drones deployed all over Europe. **Energy & mining:** International major energy companies are CLS' customers, just as major national civil engineering companies all around the globe. **Fleet Management:** + 60 000 assets tracked (Humanitarian activities, Waste management & logistics)

POINT OF CONTACT

ADDRESS 11 rue Hermes – Parc technologique du canal
31520 RAMONVILLE SAINT-AGNE, FRANCE

WEBSITE www.cls.fr

PHONE +33 (0)5 61 39 47 00

POINT-OF-CONTACT : Stéphanie Limouzin slimouzin@groupcls.com
+33 (0)5 61 39 47 00

TURNOVER 135 M€

WORK FORCE 750

SPACE TURNOVER 135 M€

SPACE WORK FORCE

Launchers Transversal competencies

Main activities:

Design, industrialization and production of systems and equipments meeting the highest standards in harsh environment.

Expertise in elaboration and production of composite & polyurethane products meeting the highest level of quality & performance requirements.

Large-size 3D controls and thermal treatment.

COMPETENCIES & CAPABILITIES

CNIM Systèmes Industriels (CSI) has an expertise in the **engineering and manufacturing of high added-value and large components** for space applications. Its expertise and competencies lies in large dimensions end-to-end projects: turning, milling, drilling, electron beam welding, large scale of high-precision controls, heat treatment.

Backed up by a long partnership with ArianeGroup, CSI now manufactures nozzle casings for the Ariane 6 launcher and cryogenic tanks components.



CNIM Systèmes Industriels

PRODUCTS & SERVICES

CSI manufactured all three-elements of Ariane 5's nozzles thanks to its expertise in precision machining and welding.

Located at the base of the boosters, the nozzles are responsible for ejecting and guiding the propulsion gases during the launcher's first stage of flight.

CSI has a state-of-the-art industrial equipment: large scale electron beam welding and now offers a new process to manufacture quicker and to reduce costs: the flow-forming technology.

CSI has both static and mobile control means, suitable for large-size and high-precision metrology (including MMT-ZEISS).

CSI has a strong expertise in Composite & Polyurethane used in space industry.

MAJOR SPACE PROJECTS & REFERENCES

Ariane Group:

/ nozzles for Ariane 5

/ nozzles for P80 - VEGA

/ ...

Other references: cryogenic tank bottoms, bulkhead, composite structures (cover, filament winding tubes), insulation of large & complex parts (polyurethane spraying, vacuum bonding)..

POINT OF CONTACT

ADDRESS : Zone Portuaire de Brégaillon – CS 60208
83507 La-Seyne-sur-Mer Cedex France

WEBSITE <https://cnim-systemes-industriels.com>

PHONE +33 (0)4 94 10 30 00

POINT-OF-CONTACT AUGERAUD Régis, Sales
regis.augeraud@cnim.com +33 (0)6 37 77 45 63

TURNOVER /

WORK FORCE 450

Orbital systems
 Launchers
 Satellites
 Balloons
 Transversal competencies



- COMAT provides equipment for legacy- and new space.
- COMAT is an SME of 95 persons located near Toulouse, close to major European space key players.
- COMAT proposes three main offers: on-demand customer equipment, off-the-shelf equipment, Industrial support in manufacturing and AIT.

COMPETENCIES & CAPABILITIES

- COMAT specialises in mechanisms for space systems, equipment for space science, and provides smallsat products.
- COMAT handles each equipment from end to end: design, manufacture, assembly, test.
- COMAT's industrial facilities include a manufacturing centre specialised in producing high-precision (5-axis machining and metrology) mechanical parts or subsystems, and integration clean rooms (ISO5, ISO7) with various test facilities.

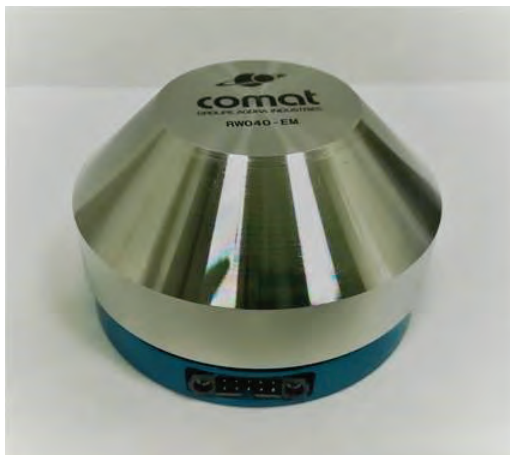

PRODUCTS & SERVICES

Product lines for constellation

- Reaction Wheels
- Deployable antennas
- Plasma Jet Pack

Equipment for space industry

- Pointing mechanisms
- Rotary Actuators
- Space pumps (Ammoniac pump, Hydrazine pump)
- Deployable mechanisms and booms Positioning mechanisms (antennas, instruments)
- Biological incubators and other equipment for manned flights and microgravity science
- Equipment for HAPS (stratospheric balloons ...)
- Any other customised equipment

Industrial support services

- Manufacturing of precision mechanical parts or sub-systems
- Manufacturing of electronic cases
- Assembly Integration & Test of systems and equipment
- AIT services at customer's premises

MAJOR SPACE PROJECTS & REFERENCES

- TRIPOD (agile 3-axis antenna pointing device)
- IASI NG (Earth observation scanner)
- PROXIMA (Scientific mission onboard the ISS)
- CHEMCAM and SUPERCAM instruments onboard the Mars
- Curiosity Rover (NASA/JPL and CNES/IRAP)
- KUBIK (Biological cooler for experiments in microgravity)
- Satellite constellations (IRIDIUM, ONEWEB, ...)
- R&D programmes for nanosat demonstrators

POINT OF CONTACT

ADDRESS 6 chemin de Vignalis
F-31130 - Flourens - France

WEBSITE www.comat-agera.com

PHONE +33 (0)5 61 24 26 16

POINT-OF-CONTACT: Ludovic DAUDOIS (CEO)
Nicolas DOLIN (Project & Product Business Developer)

TURNOVER €9m

WORK FORCE 95

SPACE TURNOVER €8m

SPACE WORK FORCE 75

Orbital systems
Launchers
Ground segments
Satellites
Balloons
Transversal competencies



CoreDux France SAS (CX) is the French facility of CoreDux Group, manufacturer of technical flexible solutions, with a history of almost a century. CoreDux designs and manufactures highly complex hose and tubing systems. The company has a wide range of market applications, including aerospace and defense. Our products are complete flexible and rigid piping systems that can be integrated into various fluid transport systems (lubricants, cooling (ammonia), oxygen, hydrogen, methane, xenon, vacuum). We work in Build to Specification and in Build to Print environments.

COMPETENCIES & CAPABILITIES

- Design & Manufacturing of Standard Products and custom Systems
- ESA and CNES registered
- Ability to Produce Small, Medium and Large volumes (from 1 to 100 000+ per year and per part number)
- Facility located nearby Paris (close to CDG Airport)



CoreDux France S.A.S.

PRODUCTS & SERVICES

CoreDux is specialized in the design (R&D), development and production of metallic and PTFE solutions particularly suited to the transport of gases and fluids in the space, semi-conductor, aeronautics and energy sectors, e-mobility, gas turbines and industrial gases.

CoreDux co-develops tailor-made products with its customers to meet their needs. We deliver exactly what you need !

CoreDux is therefore able to support its customers over the entire life cycle of a product (from ideation, to recycling, including R&D and manufacturing).

MAJOR SPACE PROJECTS & REFERENCES

Our flight heritage is expanding continuously with products mounted on launchers, satellites and stations.

Our main customers in the Space Domain are: ArianeGroup, ALAT, Thales, Airbus, ISAR Aerospace.

Our main references are Ariane 5, Ariane 6, Themis, Prometheus, Vinci, Vulcain, ELA4, Trishna, Galileo, SB NEO, SPI, Aquila, Gateway/Artemis, and many more.

POINT OF CONTACT

ADDRESS 6 Avenue du Pré des Barres, ZID de l'Omois
02400 Épaux-Bézu France

WEBSITE www.coredux.com

PHONE +33 (0)3 23 83 80 80

POINT-OF-CONTACT : RENARD, Quentin, Business Development Director

quentin.renard@coredux.com, +33 (0)6 02 11 40 24

CAMIN, Marie-Claire, Business Development Director

Marieclaire.camin@coredux.com, + 33 (0)6 70 77 50 13

TURNOVER 25 M€

WORK FORCE 150 employees

SPACE TURNOVER 10/20% (with Aeronautics)

SPACE WORK FORCE Shared resources

- Balloons
- Orbital systems
- Satellites
- Ground segments
- Transversal competencies



Creative Eurecom (CE) is a research and development company founded in 1988, that has gained strong experience over the past 30 years in the design and industrialization of complex high-tech systems combining on-board hardened electronics, mechanics and software. CE carries out projects for aeronautical (air traffic control, balloons), medical, military and various industrial fields. Via the holding OEM Development, it is coupled to the Crossway Technologies (CT) company, which manufactures small and middle series.

COMPETENCIES & CAPABILITIES

Full system design; multi-actor project engineering; functional analysis, fail-safe architectures, risk analysis; technical feasibility; requirements definition and management...

Engineering of miniaturized and embedded systems, with micro-fluidics, thermal control, sensors, actuators and optics integration. Electronics: Analog and digital circuit design and simulation, integration, verification, qualification, board design. Embedded software design and development on processor and controller; Real-time constraints; Safety features; Mechanics: Computational simulation (FEA, CFD), rapid prototyping, design for plastics processing. DFX system and product design approach. In-house prototyping facilities for electronics and mechanics.



Creative Eurecom

PRODUCTS & SERVICES

System engineering, design and development for miniaturized and embedded equipment (phase A, prototype, demonstrator).

Custom Design & Manufacturing Services:

- 'One stop shop' system & product development and industrialization
- Fast design iterations (prototypes, small and medium series)
- Test bench design

Expertise Services:

- Electronics, wireless communications, embedded software
- Expertise on standards
- Technical and methodological training
- Maintain electronic systems in operational conditions
- System redesign, obsolescence management

Products:

OBC+MC2 Electronic and mechanical embedded system serial production for balloons (36 parts / year): Command & Data Handling Systems, Data Processing Units, On Board Computers, Remote Terminal Units, Power Management Systems, EGSE, SCOE

MAJOR SPACE PROJECTS & REFERENCES

Since 2000: CNES Balloons - balloon control unit; embedded electronics design and production.

Since 2003: STNA - ILS supervisor panel for French civil airports (hardware and software design, operational maintenance).

2007-2015: Physidia - Design, development and industrialization of daily home haemodialysis machine (medical device).

2016-today: Alaxia - Design, development and industrialization of a device for the manufacture of medicaments at home (medical device)

2016-today: Exotec - electronic and software design for automated warehouse order preparation systems.

Since 92: GE Healthcare - Breast imaging robotic moving parts design and production, including electronic, motor control, control panel, hmi software.

POINT OF CONTACT

ADDRESS 39 bd de la Romanerie
49124 Saint-Barthélemy d'Anjou, France

WEBSITE www.creative-crossway.fr

PHONE [+33\(0\)2 41 73 18 18](tel:+33(0)241731818)

POINT-OF-CONTACT: Pierre-Yves Aubry, sales manager

TURNOVER: (CE+CT) 8 M€

WORK FORCE: (CE+CT) 60

SPACE TURNOVER: 0,4 M€

SPACE WORK FORCE: 10

Orbital systems
 Launchers
 Satellites
 Ground segments
 Transversal competencies



For more than 40 years, CS Group has been successfully delivering turnkey systems and providing engineering services for space and its applications markets.

With a space workforce of 430 engineers gathering advanced and unique skills in both information technologies and space programs lifecycle, CS Group is a major and proven long-term trusted partner of space and defense agencies, satellite prime contractors and operators, and space application actors.

COMPETENCIES & CAPABILITIES

CS Group is recognized as a prime contractor for space software systems. CS Group has a unique set of skills covering all domains of software within space systems from ground stations to space applications:

- Monitoring and Control & Space Flight Dynamics,
- Satellite & mission simulation,
- Electrical Ground Support Equipment & On board software,
- Mission planning & payload management,
- Image & science data processing,
- Geospatial data management & IoT mobile computing,
- Big data technologies & distributed cloud computing,
- Space Surveillance & Intelligence.



ARIANE, SOYUZ, VEGA
 ATV
 Space Surveillance

Access to space

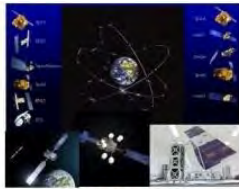

GALILEO
 SALP/SSALTO DORIS
 COSPAS-SARSAT/MEOSAR
 NEOSAT - NANOSAT

Navigation & Telecom

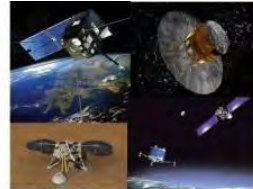

MYRIADE (Demeter, Parasol, Essaim,
 Picard, Elisa, Taranis, Microscope, ...)
 ROSETTA, GAIA, InSight ...

Science



SPOT HELIOS CSM PLEIADES SARLUPE VENUS CSO SENTINEL 2 & 3

Earth Observation

CS GROUP

PRODUCTS & SERVICES

CS Group delivers ground segment end-to-end solutions integrating added-value and qualified components. CS SI promotes open source software:

- OREKIT (www.orekit.org) for flight dynamics,
- RUGGED (www.orekit.org/rugged) for ortho-rectifications,
- OTB (www.orfeo-toolbox.org) for image processing,
- VIGILO (www.vigilo-nms.org) for network monitoring,
- DISCO for space data engineering.

CS Group proposes innovative products for ground segment operations:

- ORAAS (<https://www.orekit.space/>): Orekit as A Service,
- CS NANO: new generation nanosatellites & constellations ground segment,
- J-SMIS operational space surveillance Intelligence system.

CS Group also provides Big Data cloud agnostic solutions “as a Service”:

- SAFESCALE: a generic multi cloud management platform,
- GEOSTORM: Generic Online GeoSpatial data access, with catalog Harvesting and OGC Compliant.

CS Group provides high level consultancy and expertise for mission analysis, systems architecture, qualification and operations.

MAJOR SPACE PROJECTS & REFERENCES

- COPERNICUS/SENTINEL 2 & 3: critical image processing, Toolboxes, mission performance, Research and User Support,
- CSO/CERES: MCS prototyping and support, OREKIT as the FDS kernel,
- mission simulation and planning system,
- PLEIADES: Secure integration, Mission Programming,
- ROSETTA/PHILAE and MASCOT: Interplanetary mission analysis,
- EGNOS V3: Prediction Chain Facility, Monitoring & Control Interface Facility,
- GALILEO: Support for LEOP both at CNES and at ESOC,
- TBS: Space Surveillance & Tracking System for French Defense
- Operation Center,
- ARIANE: telemetry processing and expertise,
- ANGELS: nanosatellite ground segment.

POINT OF CONTACT

ADDRESS 6 rue Brindejonn des Moulinais
31500 - Toulouse - France

WEBSITE www.csgroup.eu

PHONE +33 (0)5 61 17 66 66

POINT-OF-CONTACT: nicolas.frouvelle@csgroup.eu

TURNOVER > €200m

WORK FORCE 2080

SPACE TURNOVER €52,25m

SPACE WORK FORCE 430

- Orbital systems
- Launchers
- Satellites
- Ground segments
- Transversal competencies



CT INGENIERIE is a French engineering company belonging to The CT Engineering Group. We support our clients throughout the entire product lifecycle, from concept to post-sales services. Our company values walking the talk while supporting clients and our established staff of engineers and technicians are proud to participate in innovative industrial programs in Europe. This has propelled our growth for the last 30 years.

COMPETENCIES & CAPABILITIES

CT INGENIERIE is recognized as a prime contractor in the aeronautical and space industries. We believe our main asset being our staff who is use to solve clients' technical challenges while operating in project mode.

For space, we are specialized in:

- o System Engineering and system optimization
- o Mechanical design and analysis
- o Physics modeling and Simulation

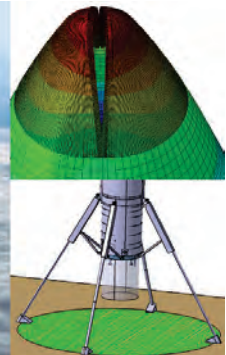

CT INGENIERIE

PRODUCTS & SERVICES

We support our clients throughout the entire product lifecycle providing services for:

Product design

- This includes engineering activities related to the definition and development of products. These are activities encompassing conceptual design and specification to detailed definition and validation of products until the production drafts are fully defined.

Manufacturing engineering

- This includes all activities associated with the fabrication of the product, from its definition, until it leaves the assembly line. It covers process planning, tooling design and digital production for instance.

In service support

- This includes all activities carried out after the product has been delivered. For example, integrated logistics support, development of technical manuals and maintenance.

MAJOR SPACE PROJECTS & REFERENCES

Selected supplier of CNES Launcher division.

Participation to Space Programs:

- Vega
- Ariane 5
- Ariane 6
- Ariane Next
- Callisto
- Prometheus

POINT OF CONTACT

ADDRESS 24 Boulevard Déodat de Séverac
31770 Colomiers - France

WEBSITE www.ctingenierie.com

PHONE +33 (0)5 62 24 85 28

POINT-OF-CONTACT : LEBORGNE, Nicolas, Business Unit Manager
commercial@ctingenierie.com , +335 62 24 85 28

TURNOVER 16,9 M€

WORK FORCE 220

SPACE TURNOVER 2,5 M€

SPACE WORK FORCE 28

Transversal competencies



CyberInflight is an independent market intelligence and consulting company dedicated to the topic of Space and Aerospace Cybersecurity. The company aims to provide to its customers an impartial and unbiased assessment of the market.

COMPETENCIES & CAPABILITIES

CyberInflight is an independent market intelligence company committed to the topic of Aerospace and Space Cybersecurity. The company performs a wide set of activities from market research to bespoke consulting, awareness trainings or project management activities in the domain of aerospace and space cybersecurity.

CyberInflight

ABOUT US

Unique player in Space & Aerospace Cybersecurity Market Intelligence

Independent company, employee owned

Founded in 2019 in France, headquartered in Toulouse

Specialized in the Space & Aerospace market

Member of:

1st

French member of the Space ISAC
Chair member of the Supply Chain Working Group (SCWG)

Part of the catalog:

CyberInFlight

PRODUCTS & SERVICES

CyberInFlight core activities have been trusted in the domain of market intelligence with one major products in its portfolio related to the space domain: “**Space cybersecurity market intelligence research report**”: this is currently under construction and is expected to be released in Q4 2022. It identifies the main trends and market intelligence indicators to be understood regarding the space cybersecurity market.

CyberInFlight can provide the following type of market intelligence oriented activities, with a strong focus on space or aviation:

- Competitive Intelligence
- Space cybersecurity regulation
- Customer profiling and segmentation
- Strategic advisory
- Market sizing and forecasting
- User surveys
- Project management and support

MAJOR SPACE PROJECTS & REFERENCES

First European Member of the Space Information Sharing Analysis Center (ISAC). Co-chair of the Supply Chain Risk Management (SCRM) Working Group

Mission on the **topic of space cybersecurity regulatory frameworks** for the European Space Agency.

POINT OF CONTACT

ADDRESS CyberInFlight

5 Esplanade Compans Caffarelli - Bâtiment A - CS 57130 - 31071
TOULOUSE CEDEX 7

WEBSITE www.cyberinflight.com

PHONE +33 (0) 6 62 39 53 75

POINT-OF-CONTACT : Rizzo, Florent, founder and CEO

florent.rizzo@cyberinflight.com, +33 (0) 6 62 39 53 75

TURNOVER

WORK FORCE 3 employees

SPACE TURNOVER

Orbital systems
 Launchers
 Satellites
 Ground segments
 Transversal competencies



CYSEC is a EU cybersecurity company founded in 2018 by experienced cybersecurity experts. CYSEC is now counting more than 36 employees between Paris, Toulouse and Lausanne. In 2019, CYSEC was selected to participate to the ESA BIC programme. In the space market CYSEC is pioneering end-to-end, European and off-the-shelf cybersecurity products for newspace missions.

COMPETENCIES & CAPABILITIES

CYSEC has become a renowned player with its products and technologies dedicated to cybersecurity for newspace players. The company has a deep expertise in:

- 1- The assessment and design of security architectures for newspace missions.
- 2- The implementation of secure satcom products
- 3- the implementation of TMTC security products.

The management team is composed of experienced space & cybersecurity managers and engineers with proven track record.

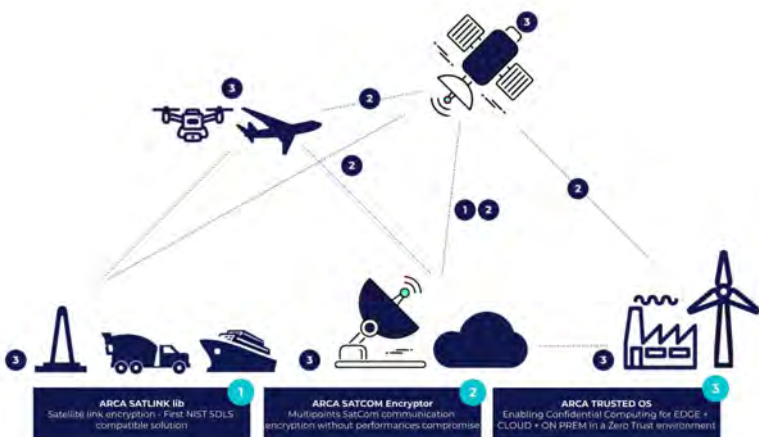

CYSEC

PRODUCTS & SERVICES

CYSEC started addressing the space market in 2019 by helping newspace satellite operators in assessing the security of their architecture and designing the security architecture of their systems.

Since then, CYSEC has developed a range of off-the-shelf products for the space market:

- **ARCA SATLINK** for end-to-end protection of satellite operations through the TM/TC link, on board and on ground.
- **ARCA SATCOM** for secure satellite communications without reducing the performance.
- **ARCA Trusted OS** to enable secure cloud-to-cloud architecture on board and on ground.

CYSEC has built a unique know-how in Europe in this very specific domain of expertise and has no direct competitors in the market.

MAJOR SPACE PROJECTS & REFERENCES

In the newspace sector, CYSEC benefits from references like Astrocast, Kleos Space, ClearSpace, LEAF Space, ICEYE, ConstellIR, Coactum, etc. From the institutional side, CYSEC has gained multiple contracts supported by ESA to:

- Develop secure satellite communications for maritime applications (2019-2020)
- Develop a secure and reliable in-orbit reconfiguration for smallsats (MDP 2020)
- Develop ARCA SATLINK on ground to be implemented and tested on a PROBA satellite simulator (2020-2022).
- Develop ARCA SATLINK on board (SDLS compliant)
- Develop secure satellite communications systems for governmental users (2021-2022)

POINT OF CONTACT

ADDRESS 250 Boulevard Saint-Germain
75007 Paris, France

WEBSITE www.cysec.com

PHONE +33 7 49 00 44 62

POINT-OF-CONTACT : Yacine FELK, COO, yacine.felk@cysec.com

TURNOVER 300k in France (1.5 M€ in total)

WORK FORCE 4 employees in France (32 employees in total)

SPACE TURNOVER 300k€ in France (1M€ in total))

SPACE WORK FORCE 4 employees in France (20 in total)

Orbital systems
 Launchers
 Satellites
 Balloons
 Transversal competencies



DACTEM is an SME founded in 1986 and based in Alès (30) with a branch in Toulouse (31). With a total of over 1000 m2 of workspace, our company specializes in the design and manufacture of test benches and measuring instruments.

More than 2/3 of our business is in the aerospace sector, but we also work in the medical, energy and automotive sectors.

DACTEM International was created in May 2023 through the acquisition of the funds and activities of DACTEM Développement by the Italian Company AEROSPAZIO Tecnologie based in Tuscany.

COMPETENCIES & CAPABILITIES

DACTEM designs and manufactures specific EGSE/MGSE/FGSE.

All our designs are based on customers' specifications, who need to carry out validation or performance tests on their products at any stage in the industrialization chain (engineering, characterization, production, quality, maintenance).

DACTEM has been awarded two CNES SME labels: Electrical ground support equipment (EGSE) and Expertise in the qualification of MIL-STD-1553 communication bus interfaces.

DESIGN AND MANUFACTURE OF AVIONICS TEST EQUIPMENT AND SPACECRAFT ELECTRIC PROPULSION TEST INSTRUMENTS



THRUSTER BALANCE



THRUSTER DYNAMIC LOAD SIMULATOR



SOLAR ARRAY SIMULATOR



BEACONS RF SIMULATOR

CONTACT US! laurent.brunel@dactem.com

DACTEM INTERNATIONAL

PRODUCTS & SERVICES

- Electric propulsion test equipments: PPU controller, PPU and thruster simulators et performance test benches, thrust balance, plume characterization.
- Platform power distribution and OBC equipment test benches
- Payload, platform and instrument simulators
- Automatic test sequencer software with script editor, test reports, CCSD PUS data decommutation,
- Avionic TM/TC front end (1553, CAN, LVDS, Space Wire).
- 1553 Interfaces Qualification from AS411 to AS4115
- Solar Array Simulator
- Leak test platform
- Hydraulic and Pneumatic test benches
- Rotative machines testers

MAJOR SPACE PROJECTS & REFERENCES

CNES :

- R&T Multiaxes Thrust balance
- Doris RF beacons simulator
- Solar Array Simulator, Nano& Microsatellite
- Hélios 2B, Pléiades, Jason3, SWOT: Doris EGSE
- Saral/Altika - CFOSAT: Platform and payload simulators
- Argos EGSE

CEA, ESA/Airbus DS, EREMS, HEMERIA, U-Space, SABCA, STEEL Electronique, THALES.

Safran Spacecraft Propulsion: PPSX00, PPS 5000, PPS 1350 HET thruster test equipment.

Thales Alenia Space: I-HAB GATEWAY EGSE, Sentinel 3 EGSE. SWIM, CFOSAT simulator, 1553 interfaces qualification.

POINT OF CONTACT

ADDRESS 1545, chemin sous Saint Etienne
30100 ALES

WEBSITE www.dactem.com

PHONE +33 (0) 4 66 54 21 00

POINT-OF-CONTACT : Laurent BRUNEL, General Manager
laurent.brunel@dactem.com, +33 (0)6 75 22 27 61

TURNOVER 2-3 M€

WORK FORCE 17

SPACE TURNOVER 1,5-2 M€

SPACE WORK FORCE 17

Space planes
 Launchers
 Satellites
 Transversal competencies



Dassault Aviation is a French aerospace company that shapes the future by designing, building and supporting military aircraft, business jets and space systems.

Thanks to its strong know-how and technical excellence in aerospace, the Company is leader on the New Generation Fighter (NGF), designer and builder of Rafale multirole fighter, special mission Falcons, Neuron and of high-end Falcon family of business jets.

The Company also designs and manufactures pyrotechnics devices and systems.

COMPETENCIES & CAPABILITIES

Competences

Integration of complex systems, Artificial Intelligence with Man-in-the-loop
 Digital flight control systems
 Hypersonic, Aerodynamics, Computational Fluid Dynamics, and Aerothermodynamics, Aircraft performance and Stealth
 Pyrotechnics equipment / systems for launchers, satellites and balloons
 Telemetry

Capabilities

Aircraft / Aero structures assembly and manufacturing
 Aircraft systems integration
 Flights tests and Certification
 Aircraft completion, MRO
 Simulation and Virtual reality



DASSAULT AVIATION

PRODUCTS & SERVICES

Over 10,000 military and civil aircraft delivered in more than 90 countries over the last century. 3100 aircraft still in service

Military aircraft: Mirage, Rafale, NGF project

UCAV: nEUROn, MALE project

Special mission aircraft: ATL2, Falcon 2000 Maritime multi-role aircraft

Business Jets: Falcon family

Space as an extension of aeronautical skills:

- Participation to IXV and Space Rider programmes (Design of shape, Aerodynamics and Aerothermodynamics computations)
- Pyrotechnics systems and devices for launchers (engine ignition, stage and payload fairing separation), satellites / Space probes (ejection, deployment of solar panels and antennas, apogee motor ignition, and unlocking of mechanisms) and balloons
- Telemetry: for ground stations for Ariane, Vega and Soyuz launchers.

MAJOR SPACE PROJECTS & REFERENCES

Ariane family (1 to 5) (ArianeGroup, RUAG): Pyrotechnics devices

VEGA launchers (AVIO / RUAG / CASA): Pyrotechnics devices

ATLAS launchers (RUAG): Pyro kits for fairing

Cassini-Huygens, Rosetta probes (CNES): Pyrotechnics devices

Hermès European Space Shuttle (ESA): design of shape, prime for aeronautics

Intermediate eXperimental Vehicle - IXV (ESA): design of aero shape, aerodynamics, aerothermodynamics,

Space Rider (ESA): aerodynamics, aerothermodynamics,

EVEREST, FLEX, Bargouzine (CNES): reusable launcher projects

Suborbital Vehicles (VEHRA Family – Internal projects): Reusable space transportation system

MLA (CNES) and **DANEO**: Design of airborne system based on Rafale or Falcon 2000 carrier for reactive launches

POINT OF CONTACT

ADDRESS 78, quai Marcel Dassault – Cedex 300
92552 Saint-Cloud France

WEBSITE www.dassault-aviation.com

PHONE +33 (0)1 47 11 40 00

POINT-OF-CONTACT: Valès Marc, VP Space activities

marc.vales@dassault-aviation.com

+33 (0)1 47 11 57 28

TURNOVER 4,400 M€

WORK FORCE 9,000

SPACE TURNOVER 12 M€

SPACE WORK FORCE 100

Orbital systems
Satellites
Transversal competencies



DYCSYT (DYnamics and Control of SYstems – Tools) is a spin-off company of ISAE-SUPAERO, created by researchers specialized in the modeling and robust control of flexible structures.

COMPETENCIES & CAPABILITIES

DYCSYT has its activity in the research and development in control engineering, and is more particularly specialized in:

- Modeling and control of flexible structures,
- Modeling of systems with parametric uncertainties,
- Robust control,
- Control/structure co-design.

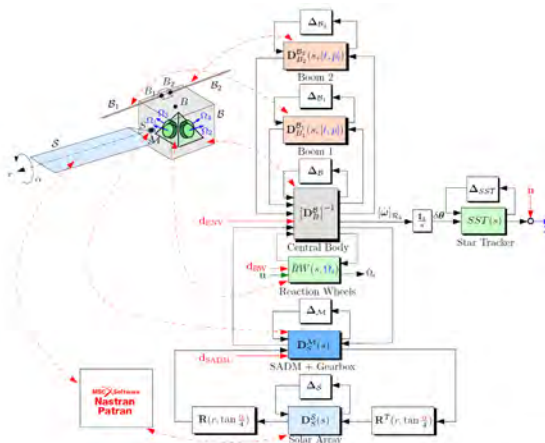

DYCSYT

PRODUCTS & SERVICES

DYCSYT develops and distributes the SDTlib (Satellite Dynamics Toolbox – Library), a modeling software dedicated to improving the GNC/AOCS design of flexible space systems. DYCSYT is also involved in projects led by ESA in partnership with satellite constructors, and proposes expertise services for studies related to the modeling and control of spacecrafts with flexible dynamics.

MAJOR SPACE PROJECTS & REFERENCES

The founders of DYCSYT have participated in many R&D projects lead by ESA in an academic context.

Scientific publications: <https://dycsyt.com/publications>

DYCSYT has carried out a first contract with the company Infinite Orbits.

POINT OF CONTACT

ADDRESS 10 Avenue Edouard Belin
31055 Toulouse, France

WEBSITE www.dycsyt.com

PHONE +33 (0)6 31 48 85 22

POINT-OF-CONTACT : Kassarian Ervan, CEO (president)
Ervan.kassarian@dycsyt.com

TURNOVER 55k€

WORK FORCE 1 employee

SPACE TURNOVER 55k€

SPACE WORK FORCE 1 employee

Ground segments
Satellites
Transversal competencies



EASii IC is a company founded in 2002 and dedicated to the design, development and manufacturing of Integrated circuit.

With a design team of more than 130 engineers cumulating 1800 years of semiconductor design experiences. We offer customized turnkey solutions for ASIC development based on customer specification.

We also propose hardware design activity for printed circuit board and software development.

COMPETENCIES & CAPABILITIES

- ASIC design, turnkey solution (Analog, mix signal, digital, RF)
- Electronic Hardware development (Application, test board)
- Automatic test bench
- Embedded Software
- FPGA design house

The graphic displays the EASii IC logo at the top center. Below it, two main service areas are highlighted: 'Your Custom ASIC' and 'Your Application Board/System'. The 'Your Custom ASIC' area includes 'DEVELOPMENT' (ASIC Design Center) and 'ELECTRONIC DESIGN CENTER DEVELOPMENT'. The 'Your Application Board/System' area includes 'ELECTRONIC DESIGN CENTER DEVELOPMENT' and 'DEVELOPMENT'. Below these are four service/product categories: 'SERVICES' (Radiations TESTS with ASER and EDA Tools with EZModTD), 'PRODUCTS' (SATCOM ASICs and Camera & Video Rec.), and 'CoaxPress ADIIS IP FPGA'. The background features a space-themed image of Earth from space.

EASii IC

PRODUCTS & SERVICES

Products:

- OXFORD-2 - Dual, 500 Mbaud, DVB-S2X Annex M, Annex E, Satellite Demodulator with Integrated Tuners and Modulator.
- X-REL High Rel, High Temperature (up to 230°C) semiconductor
- CoaXPress IP (High data rate protocol for video transfer)

Services:

- ASIC design, turnkey solution (Analog, mix signal, digital, RF),
- ASER Radiation tests bench development and tests campaign,
- Electronic design center, hardware/software development,
- CAD software, 3D modelling tool

MAJOR SPACE PROJECTS & REFERENCES

OXFORD-2 - Dual, 500 Mbaud, DVB-S2X Annex M, Annex E, Satellite Demodulator with Integrated Tuners and Modulator.

Various space ASIC development for customers in 28n FD SOI

POINT OF CONTACT

ADDRESS EASii IC

90 Avenue Léon Blum, 38100 Grenoble - France

WEBSITE www.easii-ic.com

PHONE +33 (0)4 56 580 580

POINT-OF-CONTACT: Yannick Thépaut, CEO
contact@easii-ic.com

TURNOVER 14 M€

WORK FORCE 130 employees

SPACE TURNOVER

SPACE WORK FORCE 40 employees

Launchers
Satellites
Transversal competencies



The Egide Group is a leading developer and manufacturer of hermetic packages, housings and assemblies for micro-electronic and optical product applications, with R&D and manufacturing facilities in France and in the USA.

COMPETENCIES & CAPABILITIES

Hermetic packages are needed in many defense and space applications due to their demanding and harsh environments. Egide supports multiple microelectronic manufacturers with its Ceramic-To-Metal-Seal (CTMS) and Glass-To-Metal-Seal (GTMS) technologies and participates in multiple Defense programs across Europe and the United States. Egide produces its own High Temperature Cofired Ceramic (HTCC) in France and in its US Facility.



EGIDE SA

PRODUCTS & SERVICES

Our hermetic packages can be found in Laser Range Finders, Thermal Imaging Systems, radar systems, and various electronic warfare equipment, to name just a few of the applications.

Our GTMS and CTMS packages are used in a range of applications supporting Weapon Systems, Power Supplies, Engine Sensors, Guidance and Control, Braking Systems and a host of other Microelectronic Package applications.

MAJOR SPACE PROJECTS & REFERENCES

www.Heatpack.eu with ThalesAleniaSpace

Ariane

TAS-France

IXBlue

REL

Petercem

POINT OF CONTACT

ADDRESS Site Sactar - CS 20205
84505 Bollène Cedex France

WEBSITE www.egide-group.com

PHONE +33 (0) 4 90 30 35 98

POINT-OF-CONTACT Hien, David, Directeur technique & marketing
dhien@fr.egide-group.com, +33 (0) 6 60 48 07 22

TURNOVER 30 M€

WORK FORCE 260 employees

SPACE TURNOVER 5 M€

SPACE WORK FORCE 40 employees

Orbital systems
Launchers
Ground segments
Transversal competencies

CLEMESSY

Au sein d'Eiffage Energie Systèmes, Clemessy fédère l'ensemble des compétences dédiées au monde de l'industrie.

Depuis plus de 50 ans, nos spécialistes accompagnent l'ensemble des acteurs du spatial aussi bien au niveau des infrastructures et utilités que des process :

- Fabricants de véhicules spatiaux & équipementiers
- Pas de tir et segment sol

COMPETENCIES & CAPABILITIES

De l'audit à la conception, de l'intégration à la réalisation, de la mise en service à la maintenance, nos spécialistes interviennent pour :

- la conception, l'intégration et la réalisation d'installations techniques,
- l'ingénierie, l'organisation et le pilotage de la maintenance,
- la conception clés en main, fondée sur la maîtrise de technologies innovantes, de systèmes et équipements dédiés aux essais, aux contrôles ou à la production.



CLEMESSY

PRODUCTS & SERVICES

- Ligne d'assemblage : équipements & outillages
- Validation & qualification (Intégration satellite - Maquette satellite - Panneaux solaires - Batterie Module lanceur - Booster - Propulseurs - Moteur - Avionique - Charge utile – Flatsat)
- Intégration lanceur, remplissage carburant et décollage
- Contrôle & supervision pas de tir
- Optimisation process lanceur
- Sécurité & protection des sites
- Gestion infrastructures électriques
- Moyens mécaniques
- Centres de contrôle & stations terrestres

MAJOR SPACE PROJECTS & REFERENCES

- Enter text here to indicate the main space projects, references, **CNES** Ensembles de Lancement Ariane en Guyane (ELA1, ELA2, ELA3, ELA4).
- **CNES** Ensemble de lancement Soyouz en Guyane
- Salle Blanche à Baïkonour pour **Starsem**.
- **CNES** Ensemble de préparation charges utiles en Guyane (EPCU S1, S3, S5).
- EGSE Satellite pour **AIRBUS Satellite, OHB, THALES ALENIA SPACE** (XMM, INTEGRAL, ATV, VENUS Express, ROSETTA, GAIA, COPERNICUS, SENTINEL, JASON-CS, CSO, METOP, METOP-SG, QUANTUM, MPCV, JUICE, BIOMASS, OPTSAT, K6, EarthCARE, etc.).
- Filière des bancs de contrôle ARIANE 6 pour le **CNES** et **ARIANEGROUP**.
- Atelier automatisé pour l'assemblage des Tuyères p 120C ARIANE 6 et VEGA C pour **ARIANEGROUP**.

POINT OF CONTACT

ADDRESS EIFFAGE ENERGIE SYSTEMES-CLEMESSY
France

WEBSITE www.clemessy.com

PHONE +33 (0)3 89 32 31 60

POINT-OF-CONTACT : KLINGLER Simon, +33 6 10 20 03 99
simon.klingler@eiffage.com

TURNOVER 800 M€

WORK FORCE 5000

SPACE TURNOVER 80 M€

SPACE WORK FORCE 400

Transversal competencies



ELEMCA is an independent laboratory, privately held. Our facilities are partially based in the French space agency (CNES, Toulouse – France).

Our customers are key industrials involved in demanding markets: aeronautics, space, automotive, rail, energy, electronics assembly (EMS), semiconductor devices and ALM (3D metal printing).

They rely on ELEMCA since 2003 and especially appreciate our reactivity and the high level of expertise provided in our reports.

COMPETENCIES & CAPABILITIES

We control and analyse their electronic hardware (raw materials, components and assembled boards) and ALM parts in order to:

- enable their design choices (comparative characterization of materials, digital simulation)
- qualify their products (quality control of assembly; dimensional conformity; environmental aging...)
- understand and diagnose fault at board or device-level

ELEMCA added value: a clear diagnosis, delivered by our team of experts in electronics & materials, and based on the scientific interpretation of the results obtained in our lab.

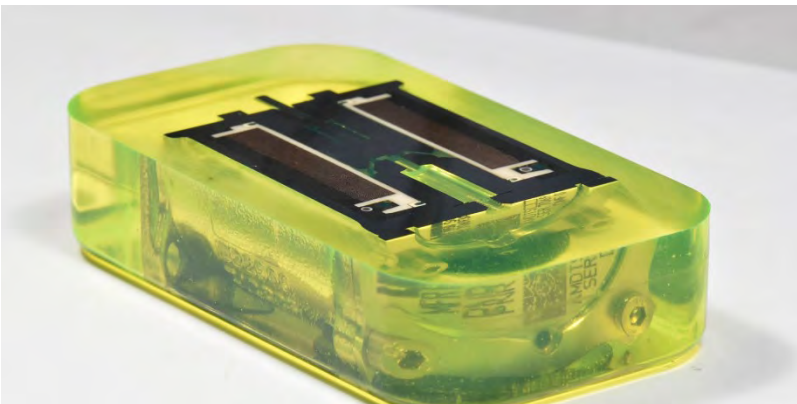

ELEMCA

PRODUCTS & SERVICES

EEE parts testing: boards & components

PCBA compliance (microsections under ECSS criteria); DPA; construction analysis; RX2D/3D; failure analysis; hermeticity testing; die shear; wire pull.

Material characterization

Outgassing (TML CVCM RML); thermal analysis (TMA, DMA, DSC, ATG) [-150°C; +500°C]; mechanical static testing (tensile, 3-points bending).

Environmental testing

Thermal vacuum; thermal cycling; climatic.
+ electrical power supply & monitoring.

MAJOR SPACE PROJECTS & REFERENCES

ELEMCA customer portfolio

Aerospace OEM AIRBUS DEFENCE & SPACE, DASSAULT, ECA AEROSPACE, ESA, ESTERLINE, LATECOERE, LEONARDO, LIEBHERR, MEGGITT, NEXEYA, SAFRAN, SODERN, STELIA, THALES ALENIA SPACE

EEE components LYNRED, RAKON, TE CONNECTIVITY, TDK, TELEDYNE

ALM parts 3D SYSTEMS, FUSIA, LAAM, OPT'ALM, POLY SHAPE, VOLUM-E, WEARE ADDITIVE

Major space programs & instruments (in collaboration with CNES): CHEMCAM, INSIGHT, JUICE, MICROCARB, MICROSCOPE, SUPERCAM, SVOM, TARANIS.

POINT OF CONTACT

ADDRESS 13, Avenue de l'Europe, 31520 Ramonville-Saint-Agne

WEBSITE www.elemca.com

PHONE +33 (0)5 61 21 76 42

POINT-OF-CONTACT : LATASTE Clovis, sales manager,
clovis.lataste@elemca.com +33 (0)6 69 46 31 01

TURNOVER 1.28 M€

WORK FORCE 15

SPACE TURNOVER 620 k€

SPACE WORK FORCE 7

Launchers
Satellites
Balloons
Transversal competencies



The company ENVIRPROD, under the trade name ARMELIO, allows us to place physics at the heart of the analysis of products and processes in order to remove the locks of our customers.

- Our way of operating is adapted to each customer's problem to: Understand, Solve then Explain and Transmit.
- Engineering, consulting and training activities, mainly on product and process innovation projects with a strong digital approach (ISO 9001)

COMPETENCIES & CAPABILITIES

A large range of skills and experiences:

- Focus on different physics and technologies
- Team of experts in product and process physics
- Team of experts in special processes (manufacturing, control)
- AI and data processing tools development
- Product and process development at target cost
- Management & realization of test campaigns (Design Of Experiments).
- Analysis of complex failures (in production and in service)

Partnerships for global answers: INOPRO (Mechaflow simulation), THEMATYS (Photonics), COMAT (space equipment).

Regional locations: Les Ulis (Paris area), Vernon, Grenoble with INOPRO, Toulouse with COMAT.

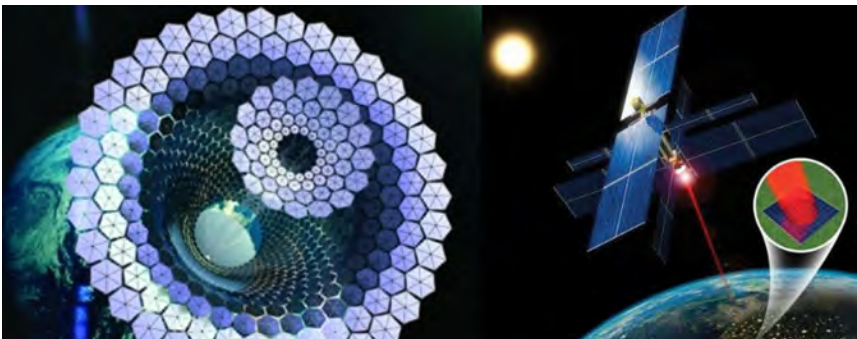

Technical and economic analysis of power transfer scenarios between spaceships

ENVIRPROD / ARMELIO

PRODUCTS & SERVICES

A large range of skills and experiences:

- Strategic, scientific and technical watch, patents, competitors, research of solutions, road map, creativity methods (TRIZ)
- Technical and economic analysis of products, processes & production
- Development of digital tools to reduce costs and simulation time
- Physical analysis and demonstration through digital simulation completed by POC or prototypes
- Design justification
- Optimization of product performance (cost, mass, lifetime)
- Development of functional digital twins
- Study and simulation of logistics and production workflows.
- Layout study and production management, Value Stream Mapping
- Study and management of investments, writing of specifications
- Study of industrialization at target cost, cost reduction
- Automation of operations, workstation ergonomics
- Performance improvement in manufacturing (study and implementation)

MAJOR SPACE PROJECTS & REFERENCES

- Ariane 5: Industrial layouts for cost reduction
- Ariane 6: Factory dimensioning for nozzle production, CPP process analysis by infusion, CPP factory dimensioning by winding
- Vinci-Vulcain: Industrial optimization (processes, automation, quality, costs)
- Prometheus: Definition of industrial scenarios and cost optimization
- Callisto & Themis: Analysis of revalidation scenarios for reusable stage
- Innovative programs: Evaluation of the principle of solar electric energy gathering and transmission, Reduction of the development cycle time of a space launcher
- R&D programs: electric propulsion for satellites, balloon gondola, pyrotechnics innovation, chemical machining applications.
- Miscellaneous: Simulator for launcher exploitation balance sheet

POINT OF CONTACT

ADDRESS 1, rue de Terre Neuve Mini Parc du Verger Bâtiment C
ZA de Courtaboeuf 91940 Les ULIS France

WEBSITE www.armelio.com

PHONE +33 (0)1 69 07 64 87

POINT-OF-CONTACT : Alain JUQUOIS, CEO, a.juquois@armelio.com

+33 (0)1 69 07 95 00 Mobile : +33 (0)6 58 58 31 40

TURNOVER 2,5 M€

WORK FORCE 30 employees (PhDs and engineers)

SPACE TURNOVER 0,6 M€

SPACE WORK FORCE 12 employees

Orbital systems
Satellites
Ground segments
Transversal competencies

EREMS
depuis 1979

Created in 1979, EREMS is a French SME specialized in the design and the realization of electronic equipment, and of associated software, mainly for the Space Segment (95% of its activity).

Endowed with engineering, manufacturing and tests services, EREMS, for 40 years, has been developing flight electronics and has contributed to the success of several hundreds of space missions.

COMPETENCIES & CAPABILITIES

EREMS skills cover power conversion, analog and digital electronics, together with embedded control and test software.

Additionally, to its engineering department (more than 80 engineers), EREMS employs space certified operators, using qualified manufacturing processes in dedicated clean rooms...

Thanks to its expertise and its capacity to manage important projects (such as the Design and Manufacture of major equipment onboard PLEÍADES NEO Observation satellites, or of electronics flying on exploration probes of the solar system), EREMS company is recognized by its customers for its commitment and the quality of its work.

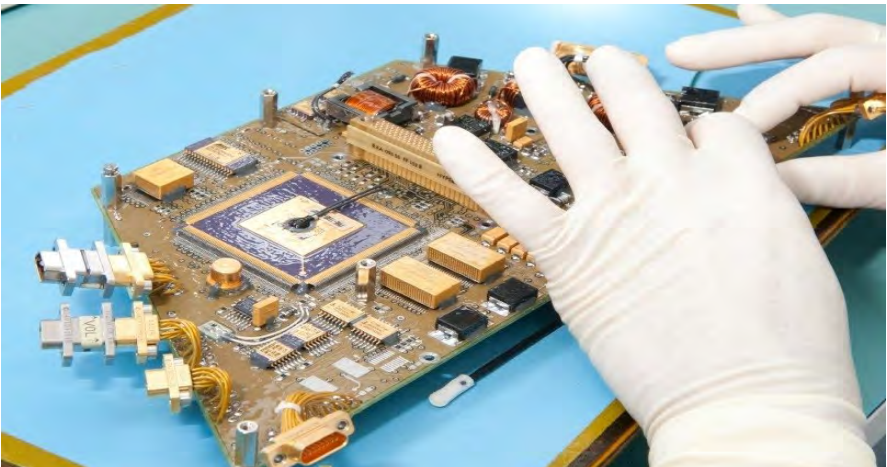

EREMS

PRODUCTS & SERVICES

Design, manufacture and tests of space flight electronic equipment or modules (adapted to customer requirements, with unitary or small series production):

- DC-DC Converters
- Power & Control Distribution Units
- High Voltage Power Supplies
- Acquisition electronics
- Front End Electronics
- Data Handling equipment, Onboard Computers
- Measurement electronics, low noise amplifiers
- Video electronics
- Interface electronics using MIL-Bus 1553, Space wire, CAN...
- Digital electronics with FPGA VHDL developments and/or with microprocessors including the development of associated software.
- Electrical Ground Support Equipment.

MAJOR SPACE PROJECTS & REFERENCES

Space Flight Electronic equipment designed and manufactured for:

- Scientific programs: ISS, TianGong, Rosetta, JASON3, InSight, BEPICOLOMBO, Exomars, Solar-Orbiter, Taranis, InSight, Angels...
- Observation satellites: IASI-NG/METOP-SG, MTG, PerùSat-1, SPOT 6/ SPOT 7, KRS, CERES, SWOT, PLEIÁDES NEO, CO3D...
- Telecom Satellites: IRIDIUM-Next, EUROSTAR 3000, Spacebus platforms, EurostarNeo, SpaceBusNeo, OneWeb...

Our reference customers: Airbus Defense and Space, CNES, ESA, Safran, Saft, ThalesAleniaSpace...

POINT OF CONTACT

ADDRESS 13 Chemin de la Madeleine, ZI F-31130
Flourens - France

WEBSITE www.erems.fr

PHONE +33 5 61 36 06 06

POINT-OF-CONTACT Gerard Dejonghe, CEO gerard.dejonghe@erems.fr

TURNOVER €15m expected in 2019/2020

WORK FORCE 150

SPACE TURNOVER €15m expected in 2019/2020

SPACE WORK FORCE 150

Orbital systems
 Satellites
 Ground segments
 Transversal competencies
 Transversal competencies



E-SPACE develops, manufactures and operate NGSO large satellite constellation for the delivery of high-availability narrowband and broadband services, with strong emphasis of space sustainability (positive impact on space debris contribution) with a highly vertical integration.

COMPETENCIES & CAPABILITIES

- Design and manufacturing satellite platform
- Design and manufacturing satellite communications payloads
- Design and manufacturing of some of the critical satellite sub-systems (GNC, ISL if needed, Solar Array, EPS, etc..)
- Satellite Assembly, Integration and Testing (AIT)
- LEOP campaign
- Constellation Operation
- Network Operation
- User Terminal and Gateway design and manufacturing

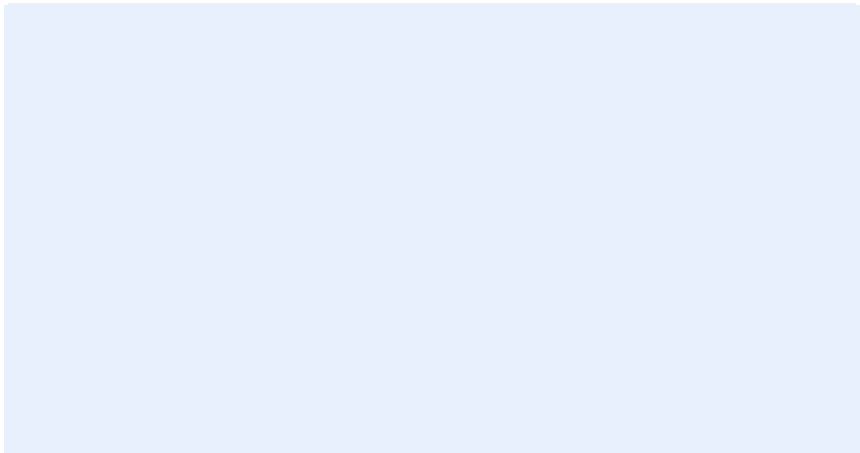

E-SPACE

PRODUCTS & SERVICES

E-Space will provide the following products:

- Large global satellite constellation infrastructure
- Communications Payload with frequency band depending on the use case
- Low Swap and Cost user terminals with frequency band depending on the vertical market and use case
- Low Swap and Cost gateway terminals

E-Space will provide the following services:

- Deploy satellite constellation Infrastructure
- Deploy satellite constellation and deliver the data connectivity service for various vertical markets and use cases

MAJOR SPACE PROJECTS & REFERENCES

- O3b
- OneWeb

POINT OF CONTACT

ADDRESS 13 rue Sainte Ursule
31000 Toulouse France

WEBSITE www.e-space.com

PHONE

POINT-OF-CONTACT : David Liermann – Tel: +33 (0)6 8723 1758

TURNOVER First years no turnover

WORK FORCE 80 employees worldwide

SPACE TURNOVER First years no turnover

SPACE WORK FORCE 80 employees worldwide

Orbital systems
 Ground segments
 Transversal competencies



ESSP – European Satellite Services Provider – is a certified Air Navigation Service Provider. The company provides satellite based services for aviation users.

ESSP's main mission is to operate and deliver the EGNOS service (the European Navigation Overlay Service), on behalf of the European GNSS Agency (GSA, an agency of the European Union).

COMPETENCIES & CAPABILITIES

- Navigation systems (GNSS, SBAS)
- Telecom satellite operations
- Critical ground systems operations
- Signal processing
- Space weather services



ESSP

PRODUCTS & SERVICES

In addition to the provision of EGNOS Services, ESSP expertise allows us to deliver new activities and projects in the fields of:

- Consultancy Services for aviation, maritime, rail, road,
- Provision of pan-European certified services for aviation,
- Provision of global, satellite-based Communication, Navigation and Surveillance (CNS) services for aviation (connected cockpit, UAV).

MAJOR SPACE PROJECTS & REFERENCES

- EGNOS, the European satellite based augmentation system, for the European GNSS Agency
- KASS, the Korean Augmentation Satellite System for KARI (South Korea)
- Iris, the satellite based communication system for aviation, a joint programme by ESA and Inmarsat
- Global Space Weather service for ICAO (International Civil Aviation Organisation)

POINT OF CONTACT

ADDRESS Bâtiment B612 – 3 rue Tarfaya – CS 84432
31405 Toulouse Cedex 4, France

WEBSITE www.essp-sas.eu

PHONE +33 5 32 26 21 41

POINT-OF-CONTACT : Neyret Charlotte, CEO

charlotte.neyret@essp-sas.eu +33 (0)6 26 65 43 59

TURNOVER 60 M€

WORK FORCE 120

SPACE TURNOVER 60 M€

SPACE WORK FORCE 120

Transversal competencies
 Satellites
 Balloons
 Launchers



Lacroix is a private family company whose core business consists in the design, manufacture and supply of pyrotechnic devices and systems to meet military, civil and space requirements. These activities cover the following main areas: protection, thermal pyrotechnic effects, training & simulation, pyromechanisms, passive expandable countermeasure for self-protection of aircraft and helicopters, IR smokes, signaling & rescue devices, illuminating and smoke devices, pyrotechnical delays, defense and space pyromechanical assemblies.

COMPETENCIES & CAPABILITIES

The Lacroix technological innovation backed by a R&D Department of over 100 specialized engineers and technicians forms the basis as a key provider of Advanced Pyrotechnics.

Lacroix provides the capacity for the rapid development of complex, highly technical and fit-for-purpose products.

This expertise gives Lacroix a leading position in the market through its:

- Ability to provide specifications for products or subsystems;
- Expertise highly technical products within budget and deadline;
- Highly competent pyrochemical department;
- In house calculation, test and evaluation facilities;
- Experience in life cycle characteristics and assessment of RMST;
- Flexible production facilities for small and medium batch.

PYROTECHNIC COMPONENTS

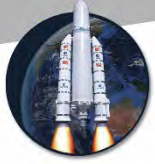
MODULAR TECHNOLOGIES FOR SPACE AERONAUTICS :
 Satellites Passivation Solution : micro-perforator
 Cutter & Hold and Release
 Customized powder formulation
 Reach free & Clean Space Solutions
 for NextGen Projects





ETIENNE LACROIX Tous ARTIFICES

PRODUCTS & SERVICES

Lacroix's core business on pyro mechanical components can be summed up in the following functions: cut, drill, initiate, secure, neutralize and actuate.

This can be achieved using different kinds of components: shaped charges, nuts, gas generators, squibs, delays, and so on.

In addition, our expertise in the chemistry of energetic materials and our laboratory and test facilities allow us to adapt the expected performances to the exact needs of the function and to carry out foresight work to ensure new functions.

MAJOR SPACE PROJECTS & REFERENCES

Lacroix is involved in many civil and military projects, whether on prospective R&D programs than for several serial productions.

- CNES
 - Micro Perforator
 - Pyrosoft: low shock HDRM
 - Opto pyrotechnic: Initiator IOP, DOP detonator
 - Virosoft, Dynasoft
- Stratospheric balloons: Cable cutter
- SAFRAN: Safety and activating mechanisms, delays, gas generators, cable cutters
- TAS: Micro Perforator (Space Clean)

POINT OF CONTACT

ADDRESS Etienne LACROIX Tous Artifices / Route de Gaudiès
09270 Mazères - FRANCE

WEBSITE www.lacroix-defense.com

PHONE +33 (0)5 61 67 79 00

POINT-OF-CONTACT : GLACIAL Frédéric
Key account Manager - Pyromechanism products
frederic.glacial@etienne-lacroix.com +33 (0)5 61 67 79 57

TURNOVER 21,7 M€ (2019)

WORK FORCE 350

SPACE TURNOVER 0,5 M€ (2019)

SPACE WORK FORCE 17

Orbital systems
Launchers
Satellites
Ground segments
Transversal competencies

Euroconsult

Euroconsult Group is the leading global consulting group specializing in the space sector and satellite enabled verticals. It is composed of two distinct, yet complementary, companies: Euroconsult and SATConsult. The group is privately owned and operates in strict independence and neutrality. Completely agnostic of governments, manufacturers, and other stakeholders, it is able to provide truly independent consulting, market intelligence, and operational services of the highest quality.

COMPETENCIES & CAPABILITIES

We accompany private companies and government entities in strategic decision making, providing end-to-end consulting services, from project strategy definition to implementation, bringing data-led perspectives on the most critical issues. We help our clients understand their business environment and provide them with the tools they need to make informed decisions and develop their business.

The uniqueness of our business model is based on synergies created by the complementarity of our four activities (consulting, market intelligence, events, training). Each activity increases our market knowledge & expertise and extends our network of key decision makers while at the same time maintaining a respect for client confidentiality.

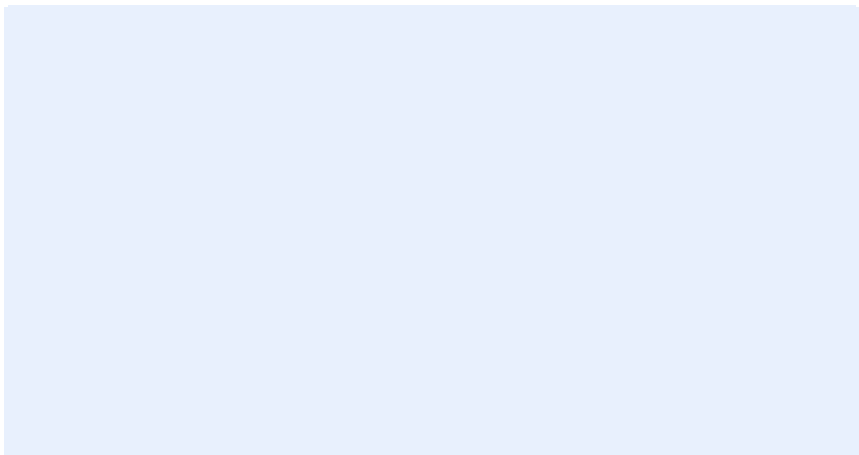

EUROCONSULT

PRODUCTS & SERVICES

Consulting: Independent assessments of business plans and government programs and policies, market analysis, financial valuations, risk assessment, due diligence, feasibility studies and operations management services.

Market Intelligence: We collect and assess market information to produce high-quality market intelligence reports. Decades of experience interpreting and analyzing millions of data points and financial filings as well as yearly industry interviews is what makes our reports so reliable.

Events: We organize summits that bring together our international executive client base. The format always includes a top-level conference featuring senior executive speakers and delegates who meet to benchmark, exchange viewpoints, and strike major deals.

Training: We provide interdisciplinary knowledge transfer to public & private entities wishing to enhance their expertise in the space sector.

MAJOR SPACE PROJECTS & REFERENCES

We conduct ~100 consulting missions yearly in the space sector globally.

A few examples of missions in 2021/2022

- Feasibility for a European secure satellite connectivity constellation
- Support to national space strategy definition
- Due diligence for an EO satellite constellation
- Future scenarios for European launcher programmes
- Commercial due diligence review of NGSO broadband constellation
- Feasibility, satellite design and support to procurement of a GEO communication satellite for a domestic operator

Clients include ESA, CNES, European Commission, Airbus, Oneweb EDA, NASA, NOAA, Canadian Space Agency, Inmarsat, MDA, Viasat, Thales, L3-Harris, KT SAT, IHI, Eshailsat, Earth Daily, Vinasat, OHB, Australia Space Agency, PT Telkom, Arabsat...

POINT OF CONTACT

ADDRESS 47 rue Louis Blanc
92400 Courbevoie - France

WEBSITE www.euroconsult-ec.com

PHONE +33 (0) 1 49 23 75 30

POINT-OF-CONTACT : Bardoux, Emeline, Sales Director
ebardoux@euroconsult-ec.com

TURNOVER 7,25 M€

WORK FORCE 68

SPACE TURNOVER

SPACE WORK FORCE 50

Launchers



EUROPROPULSION is in charge of the design and the assembly of the different solid motors which boost European launchers:

- Solid Rocket Booster for Ariane 5
- P80 for VEGA
- P120C for both Ariane 6 and VEGA-C

EUROPROPULSION is owned at 50/50 by ArianeGroup and AVIO.

COMPETENCIES & CAPABILITIES

The main competencies and capabilities of EUROPROPULSION are:

- Design of solid rocket motors with the support from both mother companies.
- Assembly of all major component in our French Guyana infrastructures.
- Qualification and tests (including Static firing tests with the support of CNES-SDS).
- Program Management of all industrial partners.



EUROPROPULSION

PRODUCTS & SERVICES

EUROPROPULSION has been incorporated in 1992. It has 2 sites:

- Suresnes: Headquarters, program Management, Sales, Finance, Engineering (15 persons)
- Kourou: Production (50 persons)

Its major customers are AVIO for VEGA and VEGA-C, ArianeGroup for Ariane 5 and Ariane 6, and ESA for all the major ground installation maintenance.

MAJOR SPACE PROJECTS & REFERENCES

EUROPROPULSION is involved in the following programs:

- Ariane 5 for the design, assembly and tests of the Solid Rocket Boosters.
- VEGA: design, assembly and tests of the P80, 1st stage of the launcher.
- VEGA-C and Ariane 6 with the design, assembly and test of the P120C, a common solid rocket motor for both launchers: 1st stage of VEGA-C and rocket boosters for Ariane 6 .

POINT OF CONTACT

ADDRESS EUROPROPULSION

11, rue Salomon de Rothschild, 92150 Suresnes

WEBSITE

PHONE +33 (0)1 46 97 83 83

POINT-OF-CONTACT : PRADIE, Emmanuel, Directeur Général Délégué,
emmanuel.pradie@europropulsion.fr, (+33) 6 94 23 26 67 (Kourou Site)

TURNOVER 310 M€

WORK FORCE 65 employees

SPACE TURNOVER 310 M€

SPACE WORK FORCE 65 employees

Ground segments
Satellites



EUROSATCOM provides SATCOM equipments for both Ground and Space segments, along with a service of installation, configuration, training and repair service (Ground segment only).

COMPETENCIES & CAPABILITIES

EUROSATCOM represents the best SATCOM equipment manufacturers in the world, and then proposes the best specifications and reliability for all equipment needed on an Earth Station. Our success for more than 25 years comes from our technical expertise, our excellent knowledges of the products we propose and our Customer satisfaction-oriented policy. With our small size activity, we have the luxury of spending the time we need on every project. We have been an official supplier of all the major SATCOM players in France since 1998.



EUROSATCOM

PRODUCTS & SERVICES

EUROSATCOM proposes the following range of SATCOM products:

Ground Segment:

- Frequency Converters
- LNA/LNB
- Power Amplifiers
- Antenna Systems
- Matrix switches
- RF Over Fiber Module converters
- Waveguides

From IF to V Bands, in all configurations (Standalone or reduded, indoor/outdoor etc...)

Space Segment:

- DC-DC converters
- Deployable antenna
- Feeds

We propose in addition to these a service of installation, configuration, training and repair for all the proposed equipments.

MAJOR SPACE PROJECTS & REFERENCES

We have been working mainly on Defense programs but not only:

- Syracuse 3, 4
- Konnect
- Galileo
- Athena Fidus
- Comcept
- TEBA
- SGDC
- YAHSAT
- CESARS

POINT OF CONTACT

ADDRESS 3 Avenue du Canada
91940 Les Ulis, France

WEBSITE www.eurosatcom.eu

PHONE +33 (0)1 69 18 19 30

POINT-OF-CONTACT : Nasrallah Samy, Managing director
snasrallah@eurosatcom.eu, +336 47 96 80 96

TURNOVER 3 M€

WORK FORCE 3 employees

SPACE TURNOVER 3 M€

SPACE WORK FORCE 3 employees

Satellites
Ground segments
Connectivity



Established in 1977, Eutelsat Communications is one of the world's leading and most experienced operators of communications satellites. The company provides capacity on 34 satellites in geostationary orbit to clients that include broadcasters and pay-TV operators, telcos, Internet Service Providers, enterprises, and government agencies. Eutelsat's satellites provide ubiquitous coverage of Europe, the Middle, East, Africa, Asia, and the Americas. Eutelsat is shaping a fast-evolving digital society and enabling connectivity for all, specifically those beyond the confines of existing terrestrial infrastructure.

COMPETENCIES & CAPABILITIES

Eutelsat is an expert in the full satellite operations value chain, with over 40 years of experience in the global satellite industry.

Its competence covers regulatory, procurement (space and ground), financial, operational, commercial and innovation activities.

Eutelsat also provides support for third party satellite operators and emerging space-faring nations and carries hosted payloads for government agencies.



EUTELSAT

PRODUCTS & SERVICES

Eutelsat provides capacity for national and international communications (video, streaming, gaming, data, government, fixed and mobile broadband). Since 2022 Eutelsat has accelerated its Telecom pivot and Connectivity business.

Its fleet of satellites operates in C, Ku and Ka-band frequencies and includes widebeam footprint satellites adapted to video and data broadcasting and High Throughput Satellites and payloads for fixed and mobile broadband.

The company can also provide regulatory support, procurement, training, in-orbit control services and can accommodate hosted payloads.

Products and services for IP markets include Eutelsat CIRRUS, hybrid satellite DTH and OTT delivery solution, and IoT First, a simple and integrated solution that uses Ku-band satellite capacity. More than 1150 transponders on board 34 satellites.

MAJOR SPACE PROJECTS & REFERENCES

Eutelsat collaborates with leading industrial partners that include Airbus, Thales, SSL, Orbital, and Boeing.

90% of the Eutelsat satellites are provided by the European Industry

Launch agencies: Arianespace, SpaceX.

We have long-term relationships with national and international launch agencies that include ESA, the CNES, ASI and the UK Space Agency.

A 1200-strong team is capable of pursuing up to seven satellite programmes in parallel.

Some of the multiple innovations driven by Eutelsat include Very High Throughput Satellites, electric propulsion and software-driven satellites.

POINT OF CONTACT

ADDRESS 32 Boulevard Gallieni
F-92130 – Issy-les-Moulineaux

WEBSITE www.eutelsat.com

PHONE +33 (0)1 53 98 47 47

POINT-OF-CONTACT: Anita Baltagi, External Communications Director

TURNOVER €1,2B

WORK FORCE 1200

SPACE TURNOVER N/A

SPACE WORK FORCE N/A

Ground segments
 Transversal competencies



EVERSAT designs, manufactures and markets satellite communication equipments for broadcast, defence and security markets, with a focus on mobile satellite terminals.

COMPETENCIES & CAPABILITIES

Created in 2006, Eversat is located in Paris-Saclay business cluster, one of the most dynamic technological places in the world. Eversat has been awarded top 50 best startup of the year by the French Ministry of Research. Due to its unique Research and Development efforts, the company provides reliable and cost effective products offering unmatched performance.

From the design to the After-Sales Support, Eversat has a strong experience in satellite communications equipments.

The technical skills of Eversat are: microwaves, software, electrical, electronics, mechanical and network engineering.



EVERSAT

PRODUCTS & SERVICES

Eversat provides a complete range of mobile satellite terminals ideally suited for broadband INTERNET access (voice, data, video) from anywhere in the world:

- "LightAway" satellite suitcases: the most powerful and integrated satellite suitcases in the market
- "DriveAway" vehicle mounted antennas: the most intelligent antenna systems in the market

Eversat products offer an ideal solution for end users wishing to improve their communication systems and to minimize operating expenses.

In addition to its products, Eversat provides system integrations such as satellite earth stations (teleport) and satellite vehicles.

MAJOR SPACE PROJECTS & REFERENCES

Eversat addresses 3 main markets:

- Broadcast
- Defense
- Security

The main references of Eversat are: Actia Telecom, Airbus Defence and Space, BFMTV, France Televisions group, French Civil Protection, National Gendarmerie, TF1, etc.

POINT OF CONTACT

ADDRESS	102 route de Limours, Domaine de Saint-Paul, Bâtiment 10 78470 Saint-Rémy-lès-Chevreuse, France
WEBSITE	www.eversat.eu
PHONE	33 (0)185 400 973
POINT-OF-CONTACT	Rakotoarisoa, Bruno, President, bruno.rakoto@eversat.eu , +33 (0)6 08 87 44 24
TURNOVER	2 M€
WORK FORCE	8 employees
SPACE TURNOVER	2 M€
SPACE WORK FORCE	8 employees

Orbital systems
Launchers
Satellites

exail

Exail (formerly iXblue) is a global high-tech company specializing in the design and manufacturing of advanced marine, photonics and autonomy technologies. Exail develops systems for complex applications in extreme environments, from the ocean depths to outer space. Exail was one of the first companies in the world to develop the Fiber-Optic Gyroscope (FOG) technology and is now a recognized leader on this market.

For space application, in partnership with Airbus Defense & Space, Exail has developed the Astrix family, a range of space fiber-optic gyroscopes. Exail also designs and manufactures space grade optical components such as optical modulators, rad-hard fibers, fiber sources and amplifiers.

COMPETENCIES & CAPABILITIES

With a **dedicated team for space products** for more than 20 years, Exail has end-to-end control of its value chain, from the R&D carried out in its engineering offices through manufacturing in the company's own production shops and quality control.

Production sites have **large clean rooms** for the manufacturing of space components and systems.

Numerous **skillful inertial experts** are available together with **all the required inertial and environmental means** to develop, test and qualify products.

Exail supplies numerous space actors (ESA, CNES, Airbus for instance...) **following ECSS standards.**

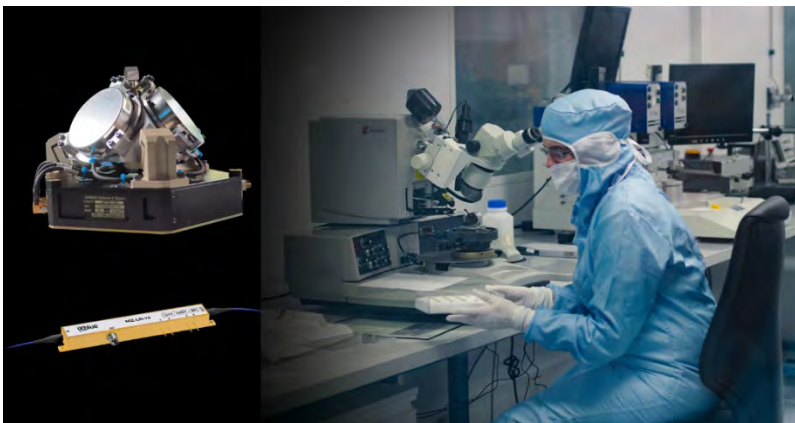

PRODUCTS & SERVICES

Gyroscope for satellites and space probes:

- The Astrix series: high-performance space fiber-optic gyroscopes for military, scientific and telecom applications, developed in partnership with Airbus Defence & Space for more than 20 years
- Astrix NS: a new, compact and competitive gyroscope for new space

Inertial navigation system for launchers:

- The safety inertial navigation system for Ariane launchers. It has been qualified in flight since 2020

LiNbO₃ optical modulators for space applications

- Amplitude and phase LiNbO₃ modulators for laser communication terminals from satellites to satellites and from space to ground
- Phase LiNbO₃ modulators for laser cavity stabilization

Space grade optical fibers

- SM and PM radiation hardened fibers with a large choice of coatings
- Erbium and erbium/ytterbium doped fibers for sources and amplifiers
- Custom design of space grade optical fibers, as well as fiber sources and amplifiers

MAJOR SPACE PROJECTS & REFERENCES

Exail works with all major space agencies. Its components and systems have been selected by major space players and are on-board numerous missions like Pleiade, Aeolus, Sentinel 2, MTG, Exomars...

- Astrix gyroscopes are on board **dozens of satellites** representing more than 6 million hours of cumulated flight without incident
- **Pléiade satellites** were the two first satellites using Astrix 200. They were launched in 2011 and are working well since then.
- Exail manufactures **Ariane 5** safety inertial navigation system
- Exail modulators are on board **Sentinel 1a and Sentinel 2a**, the GEO satellite Alphasat and NASA GRACE-FO mission

CONTACT POINT

ADDRESS: Exail, 34 rue de la Croix de Fer, 78 100 Saint-Germain-en-Laye

WEBSITE: www.exail.com

PHONE: +33 (0)1 30 08 88 88

CONTACT POINT: Guillaume Lecamp, head of space activities
guillaume.lecamp@exail.com

TURNOVER: 120 M€

WORK FORCE: 650

Orbital systems
Launchers
Satellites
Ground segments
Balloons
Transversal competencies

exail

Exail (formerly ECA GROUP) is a significant player in the supply of satellite communications solutions to major space actors. We design and manufacture systems dedicated to Aerospace, Ground Stations for Earth Observation & Telecommunications Satellites, Launchers, Spacecraft or UAV.

Exail provides Antenna Tracking Systems, Satellite Link and Payload Simulators, Stratospheric Balloon Systems, In-Flight Connectivity Systems, Search & Rescue Beacons and Ground Support Equipment.

COMPETENCIES & CAPABILITIES

Exail covers the entire value chain from design, research, engineering, industrialization, production up to through-life support. The company takes full advantage of its competencies in Radio Frequency and Digital Processing of Signals in the space sector by offering a range of On-Board Equipment and Ground Support to ensure data transmission via satellite. Exail is also specialized in Mechanical Engineering of high precision.



Exail

PRODUCTS & SERVICES

- **PROPAGATION CHANNEL EMULATOR PCE600:** a highly efficient and versatile propagation channel emulator designed to secure your wideband telecom-links and latest modulation.
- **TRACKING SYSTEMS** innovative and complete solution in response to the auto track requirement: the Compact Tracking Receiver (CTR70 – 70 Mhz or CTRD – 720 Mhz), with the Tracking Down Converter (TDC).
- **NAVYS RF GNSS CONSTELLATION SIMULATOR:** a highly flexible simulator to perform advanced testing of GNSS receivers and systems. A project co-developed with a major space manufacturer.
- **FAILSAFE BOARD AND GROUND SYSTEMS** dedicated to scientific operations using stratospheric balloons.
- **MECHANICAL & ELECTRICAL GROUND SUPPORT EQUIPMENT** for satellite and next generation launcher integration.
- **ELiTe, Emergency Locator Transmitter (ELT)** allows the activation of RF signals to alert Search & Rescue (SAR) teams through the COSPAS SARSAT SYSTEM.

MAJOR SPACE PROJECTS & REFERENCES

With a recognized expertise of more than 40 years, Exail meets the requirements of major space actors: space agencies & scientists, satellite and telecommunications operators, satellite payload manufactures, broadcast operators, telecommunications modem manufacturers, antennas manufacturers and suppliers

- **NOSYCA** Global system dedicated to stratospheric balloon operations
- **DORIS** Doppler Orbitography by Radiopositioning Integrated on Satellite
- **CALBE CALibration Beacon** for MEOSAR systems
- **ESR (boosters) Integration Means & Upper Composite Handling Systems** for the most known European Space Program

POINT OF CONTACT

ADDRESS ZAC de St Martin du Touch, 6 Impasse Alice Guy
31300 Toulouse, France

WEBSITE exail.com

PHONE +33 (0)5 62 11 17 17

POINT-OF-CONTACT : eca-aerodivision@exail.com

TURNOVER 124 M€ (2022)

WORK FORCE 700

SPACE TURNOVER 28 M€ (2022)

SPACE WORK FORCE 192

Launchers
Satellites
Ground segments
Transversal competencies

The logo for COBHAM, featuring the word "COBHAM" in a bold, blue, sans-serif font. The letters are slightly shadowed, giving it a 3D appearance as if it's floating or attached to a surface.

Cobham Microwave is one of the world's leading providers of passive RF & Microwave components; equipment and sub systems to the international space market segment.

Cobham Microwave has a rich legacy in delivering both standard and highly custom differentiated solutions. Our innovative and high performance solutions provided, enable our customers to perform to their maximum potential.

COMPETENCIES & CAPABILITIES

With more than 40 years space heritage, our space approved RF & Microwave sub-systems, equipment and components have been integrated on more than 1000 satellites.

Our Space qualified processes includes: dip brazing, vapour phase, thin-film, ceramic, ferrites assembly, alochrome, silver or gold plating and painting.

In house screening equipment includes: high power vacuum test, intermodulation, Multipactor, Corona, thermal cycling, EMC, Life tests, Die shear tests, Pull tests, Gross and fine leakage, Vibrations and accelerations test, PIND tests (Particle Impact), Noise detection.



COBBHAM MICROWAVES

PRODUCTS & SERVICES

Using leading edge space qualified technologies and world class engineering team, Cobham Microwave has developed an impressive portfolio of space products including:

- integrated sub-systems,
- isolators and circulators,
- RF filters & duplexers (lumped elements, air cavity, waveguides, ceramic and AFSIW)
- Silicon diodes & MOS capacitors, RF baluns
- Modules (mixers, power dividers, switches...)
- Waveguides and waveguide equipment (flexible, rigid, rigid-flex, waveguide to coax adapters, test couplers, power dividers, ...)

Cobham Microwave is also manufacturing innovating solutions for the satellite and launchers industry (EGSE)

MAJOR SPACE PROJECTS & REFERENCES

Space Agencies: ESA, CNES, ISRO, CAST...

Major Primes in Satellite industry: THALES ALENIA SPACE, AIRBUS DEFENSE AND SPACE, ONEWEB SATELLITES, THALES ELECTRON DEVIVES, OHB, SSL, NORTHROP GRUMMAN INNOVATION SYSTEMS, MDA, IAI, NEC, CASC, SSSL, SENER, TESAT, KONGSBERG, RESHETNEV, SATREC, RUAG

Major Prime in Launchers industry: Ariane Group, ISRO, CAST...

POINT OF CONTACT

ADDRESS 29 Avenue de la Baltique, ZA Courtaboeuf,
VILLEBON-SUR-YVETTE, 91140, France

WEBSITE www.cobham.com/electrical-and-electronic-equipment

PHONE +33 (0)1 69 59 98 00

POINT-OF-CONTACT : Brice GLORIEUX, brice.glorieux@cobham.com
M : +33 6 74 78 76 94

TURNOVER 31.3 M€

WORK FORCE 193

SPACE TURNOVER 45%

SPACE WORK FORCE 105

Orbital systems
Satellites
Ground segments
Transversal competencies



Exotrail is a start-up company designing electric propulsion systems and propulsion related software for the small satellites sector.

Exotrail's mission is to deliver agility to the space industry. We enhance constellations of small satellites by optimizing launch and deployment strategies, improving resolution, coverage, lifespan and overall performance, while also providing sustainable solutions that do not add to existing space debris.

COMPETENCIES & CAPABILITIES

- Electric Propulsion System Design (incl. fluidics and electronics)
- System Engineering
- Assembly, Integration & Testing of Electric Propulsion System
- Mechanical & Thermal simulation
- Material & Processes Expertise
- Mission Design Software
- Mission Operation Software
- Flight Dynamics & Space Mechanics
- Product & Quality Assurance
- Project Management



EXOTRAIL

PRODUCTS & SERVICES

Exotrail addresses the propulsion need of the small satellite market, offering a product portfolio composed by electric propulsion systems and software tools:

- ExoMG™-*nano*, a 60W/2mN Hall thruster for 10-20kg satellites;
- ExoMG™-*micro*, a 150W/7.5mN Hall thruster for 20-100kg and more satellites;
- ExoOPST™-*Mission Design*, a cloud-based software that helps engineers to design and plan the operations of your satellite missions;
- ExoOPST™-*Operations*, a cloud-based software that helps operators in optimizing the operation of satellite and constellations;

MAJOR SPACE PROJECTS & REFERENCES

- **Commercial contract with AAC Clyde Space** for the provision of 2 ExoMG™ flight models by the end of 2020, with option for tens in the following years, to equip the satellites of **Eutelsat ELO constellation**;
- **In Orbit Demonstration** flight model delivered in September 2019 (**only 10 months to design, manufacture and qualify the system**), originally scheduled to be launched in November 2019, currently planned in March 2020 due to launcher delays;
- **Several R&D project with CNES and ESA** for the development of new technology to be applied on the future versions of ExoMG™;
- ExoOPST™ – *Mission Design* commercially available. First licenses sold to customers, including **Eutelsat**.

POINT OF CONTACT

ADDRESS 3 Rue Galvani, 91300 Massy, France

WEBSITE <https://exotrail.com/>

PHONE +33 (0) 6 30 66 33 32

POINT-OF-CONTACT Henri, David, CEO & Co-founder
david.henri@exotrail.com, +33 (0)630 66 33 32

TURNOVER Confidential

WORK FORCE 25

SPACE TURNOVER Confidential

SPACE WORK FORCE 25

Launchers
Satellites
Ground segments
Transversal competencies



A reliable partner for your bold ambitions

Expleo is a global engineering, technology and consulting service provider that partners with leading organisations to guide them through their business transformation, helping them achieve operational excellence and future-proof their businesses.

COMPETENCIES & CAPABILITIES

- **Assembly integration and test:** Avionic, RF & mechanical operations, EGSE MRO (Avionic & RF)
- **GSE Development:** EGSE (RF, Avionic), MGSE, OGSE.
- **HW & SW development & validation** (On-board / off board)
- **Quality:** Inspection, product assurance, AIT quality insurance
- **Engineering:** Electronic & Embedded System (RF, FPGA, Num, Analog & Power), Mechanical & Thermal Engineering,
- **Testing facilities:** Electronic & RF Laboratory and 300m² ISO 8 clean Room in Toulouse
- **NewSpace:** CubeSat Payload design/integrator (In house), tests and validation solutions.
- **Manufacturing:** product industrialization, process design



EXPLEO

PRODUCTS & SERVICES

The New Space Era must solve new challenges such as orbital debris, climate change, security and commercial exploration. From satellite design to space data management, through next-gen ground systems equipment, Expleo develops and tests new products and services that are scalable, smarter and more sustainable. With our partners, we bring the wonders of space to the world, connecting the possibilities of space with life on Earth.

A Deep range of services to drive your success

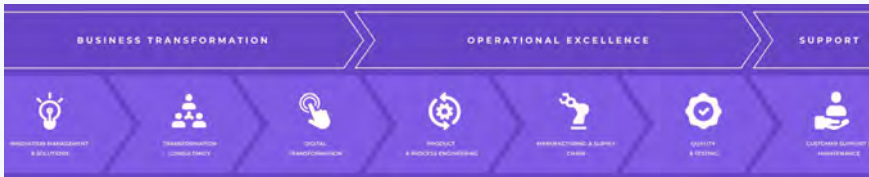

MAJOR SPACE PROJECTS & REFERENCES

AIT: OneWeb, Eurostar platforms, SpaceBus Platforms GlobalStar, O3b, Iridium Next, Mars Insight, Super Cam,

NewSpace: ENSO, DjibSAT 1A/1B

EGSE: AIT TCR Benches for ADS, Telecom equipment EGSE for TAS

EXPLEO Clean Room: Testing & tuning of RF Telecom equipment (TrRF, LDLA, // Gap tuning, flight model wiring) for TAS in EXPLEO facilities.

Our reference customers: Airbus Defense & Space, Thales Alenia Space, CNES, ArianeGroup, OHB, OneWeb Satellites, ONERA

POINT OF CONTACT

ADDRESS EXPLEO FRANCE 3 AV DES PRES

78180 MONTIGNY-LE-BRETONNEUX France

WEBSITE <https://expleo.com/global/fr/industries/spatial/>

PHONE 05 34 39 60 00

POINT-OF-CONTACT : Frederique REBOUT - Global Head Of Space

frederique.rebout@expleogroup.com, +33 7 72 14 92 80

TURNOVER 1 bn €

WORK FORCE 15 000 employees

SPACE TURNOVER 35 M€

SPACE WORK FORCE 350 employees

Transversal competencies



Exxelia is a designer and manufacturer of ruggedized passive components and subsystems focusing on highly reliability markets, including Space.

With 50+ years' experience in Space, Exxelia components are onboard numerous satellites, exploration, programs such as Iridium, Galileo, Perseverance Rover, InSight, OneWeb.

COMPETENCIES & CAPABILITIES

- 200m2 clean room (class Iso8)
- Quality Multi-Steps Process Inspection
- In-house testing equipment for LAT testing
- Different screening levels available for new space
- Strong custom design capabilities : design & engineering support
- No obsolescence
- Use of low outgassing materials only



EXXELIA

PRODUCTS & SERVICES

- Exxelia product portfolio includes wide ranges of
 - **Capacitors** : ceramic, film, tantalum, electrolytic, adjustable
 - **Resistors** : high voltage, high resistance
 - **EMI-filters** : C, L, Pi and T types
 - **Inductors & transformers**
 - **Dielectric and coaxial resonators**
 - **Tuning elements,**
 - **Position sensors**
 - **Slip rings.**
- More than 50 ESCC QPL product series and manufacturing processes related to capacitors (ceramic, film, tantalum), magnetics (RF inductors, self/transformer processes), EMI-filters
- Sole QPL manufacturer for EMI-filters

MAJOR SPACE PROJECTS & REFERENCES

From Space exploration missions to New Space constellations, from launchers to military satellites, Exxelia is present on numerous space programs such as Iridium, Galileo, OneWeb, Meteosat, ATV, Rosetta, Perseverance Rover, InSight probe, Solar Orbiter, Juice, Exomars, Ariane 5 & 6.

POINT OF CONTACT

ADDRESS 93, rue Oberkampf, 75011 PARIS - France

WEBSITE www.exxelia.com

PHONE +33 (0)1 49 23 10 00

POINT-OF-CONTACT : EVRARD Marie

marie.evrard@exxelia.com

+33 (0)1 49 23 10 66

TURNOVER

WORK FORCE

SPACE TURNOVER

SPACE WORK FORCE

Ground segments
Transversal competencies



FDC is an independent research and consulting company specialised in the field of space applications and security.

COMPETENCIES & CAPABILITIES

Since 1989, FDC has been offering a unique blend of expertise in Positioning, Navigation & Timing (PNT), Earth Observation, Telecom and Security to private and public organisations in both the civilian and military domains.



Earth Observation



Positioning, Navigation
& Timing



Telecommunication



Business
Consulting
& Management



Technology
Consulting



Research,
Development
& Innovation



Security

PRODUCTS & SERVICES

FDC deploys tailor-made teams of highly qualified engineers to perform:

- Business Consulting and Programme Management (incl. project & programme management, user requirements gathering & exploitation, definition of services and concept of operations)
- Technology Consulting (incl. technical & operational analysis, technology monitoring, vulnerability analysis and mitigation, countermeasure definition, support to standardisation and certification, demonstrations, security operations management)
- Research, Development and Innovation (incl. development of test tools, software & hardware developments including secure firmware, corresponding IPs).

MAJOR SPACE PROJECTS & REFERENCES

- Contribution to Galileo and Copernicus Missions Definition
- Development of a secure GNSS sensor combatting spoofing and jamming and offering end-to-to end security (DRACONAV)
- Development of a military GPS monitoring station
- Development of the Galileo OSNMA test receiver
- Organisation of Galileo PRS Pilot Projects
- Galileo security and PRS supply chain analysis
- Organisation of Copernicus training session
- Contribution to the GSA GNSS Market Report and User Technology Report
- Responsible for the technical content and conferences of the EU Space Exhibition (~1 Million visitors across Europe)

POINT OF CONTACT

ADDRESS 10 Cours Louis Lumière – 94300 Vincennes - France

WEBSITE www.fdc.fr

PHONE +33 (0)1 53 66 11 11

POINT-OF-CONTACT Pascal CAMPAGNE, pascal.campagne@fdc.eu

TURNOVER ~3 M€

WORK FORCE ~20

SPACE TURNOVER ~3 M€

SPACE WORK FORCE ~20

Ground segments
Transversal competencies



Founded in 1987, Fleuret is specialized in technical solutions to support its customers in their logistics and maintenance.

We develop products securing intra-site transport, in situ handling and external storage of high value added equipment and components.

We also ensure the qualification and certification of our products in accordance with European and international regulations, and their maintenance around the world.

COMPETENCIES & CAPABILITIES

Our capabilities in our areas expertise:

- Research & Development (8p)
- Manufacturing Integration (12p)
- Tests Qualifications (2p)
- Quality documentation (2p)
- Customer support (1p)



FLEURET SAS

PRODUCTS & SERVICES

With 25 years of experience FLEURET has developed a large range of products in 2 sectors:

1. TECHNICAL CONTAINERS:
 - Aluminum/Steel Welded
 - Composites panels
 - Wood and Plywood
 - Polyester
2. GROUND SUPPORT EQUIPMENT:
 - Transportation jigs/Intro logistic trolleys
 - Assembly Frame

MAJOR SPACE PROJECTS & REFERENCES

- METOP MWI Container – SONACA
- IBDM HCS Transport Container – SENEER
- SL SIGMA RL90 Container – SAFRAN ELECTRONIC & DEFENSE
- OBA Container – GRADEL/OHB
- NAOMI-C MIROR GSE/Container – AIRBUS DEFENSE & SPACE
- AMUX PM BAS Container – THALES
- ISO5 Char & Container – CEA-CESTA

POINT OF CONTACT

ADDRESS 17 AV de la MARQUEILLE 31650 SAINT ORENS, FRANCE

WEBSITE www.fleuret-toulouse.com

PHONE +33 (0)5 61 39 06 32

POINT-OF-CONTACT : TOURNIER Nicolas Sales

n.tournier@fleuret-toulouse.com, +33 (0)6 40 58 27 83

TURNOVER 15 M€

WORK FORCE 200 employees

SPACE TURNOVER 1 M€

SPACE WORK FORCE 25 employees

Satellites
 Ground segments
 Transversal competencies



Fluctus SAS is a French company established in 2019 providing scientific support for the:

- Design of future space-based Earth observation instruments.
- Definition and improvement of ground processing systems.
- Calibration and validation of the observations, from raw data to geophysical products.

The core competence of Fluctus SAS is in microwave radiometry, due to more than 15 years of experience of its founder, Bruno PICARD in this domain.

COMPETENCIES & CAPABILITIES

Fluctus provides scientific support to space agencies and satellite manufacturers for the development or the improvement of earth observation missions.

Fluctus develops end-to-end simulators for the performance assessment of future missions. We are also developing and validating new scientific algorithm to improve on-going missions, using signal processing, inverse problem approach, data science and machine learning methods.

Bruno Picard is a senior scientist with expert level skills on handling numerical weather prediction models, radiative transfer model, retrieval of atmospheric parameters (temperature, humidity, precipitations) and microwave radiometry in general.

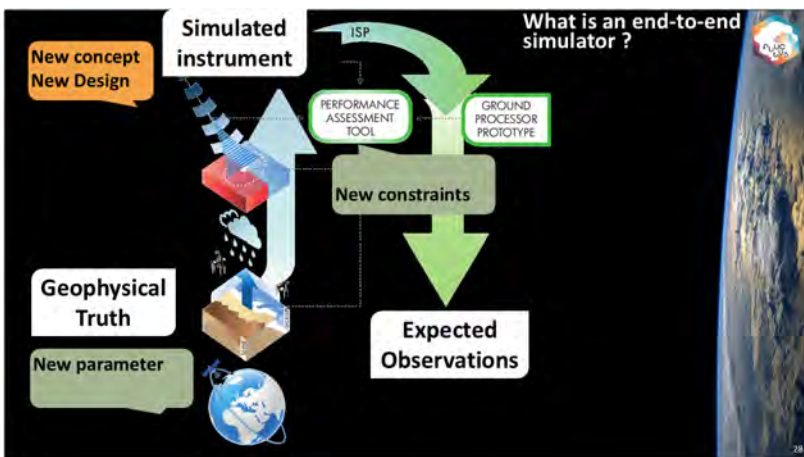

FLUCTUS

PRODUCTS & SERVICES

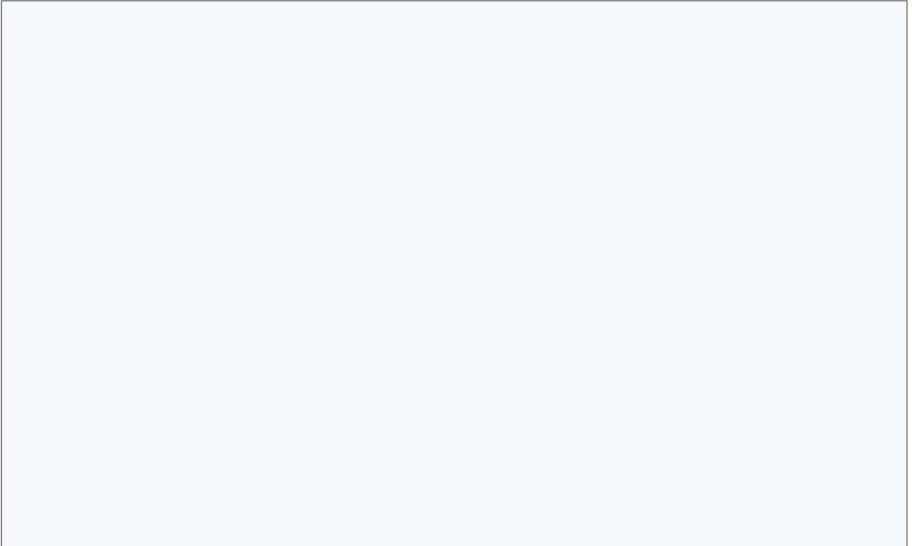

MAJOR SPACE PROJECTS & REFERENCES

Since its creation, Fluctus SAS has been successfully involved in various projects and studies for major space agencies:

- Eumetsat: Sentinel-3, Metop-SG
- ESA: Sentinel-6 NG (in collaboration with Airbus Spain)
- CNES: SWOT, SaphirNG, Climate (with IPCC expert)

Fluctus is also working in a close collaboration with Frank Fell (Informus GmbH) and Ralf Bennartz (Prof. at University of Vanderbilt, US), two senior scientists in Earth Observation.

POINT OF CONTACT

ADDRESS 2 rue Henri Prouho
81800 Rabastens, France

WEBSITE <http://satobsfluctus.eu/>

PHONE +33 (0)6-65-93-22-67

POINT-OF-CONTACT : Bruno PICARD, managing director, senior scientist

TURNOVER 200 k€

WORK FORCE 1 employee

SPACE TURNOVER 200 k€

SPACE WORK FORCE 1 employee

Ground segments
Balloons
Transversal competencies

FLYING
WHALES

FLYING WHALES designs the biggest airship in the world to transport heavy and bulky loads (up to 60 tons). The maiden flight of the first airship is planned for late 2025. The company is backed by French Government (France 2030), Quebec Government, Nouvelle-Aquitaine Region, Air Liquide, ADP, Bouygues and other companies.

COMPETENCIES & CAPABILITIES

FLYING WHALES is leading a consortium of more than 40 aeronautics companies to assemble the largest airship in the world. The fields of expertise are then very diverse, to cover every systems, sub-systems, materials, architecture, manufacturing (assembly process), certification.

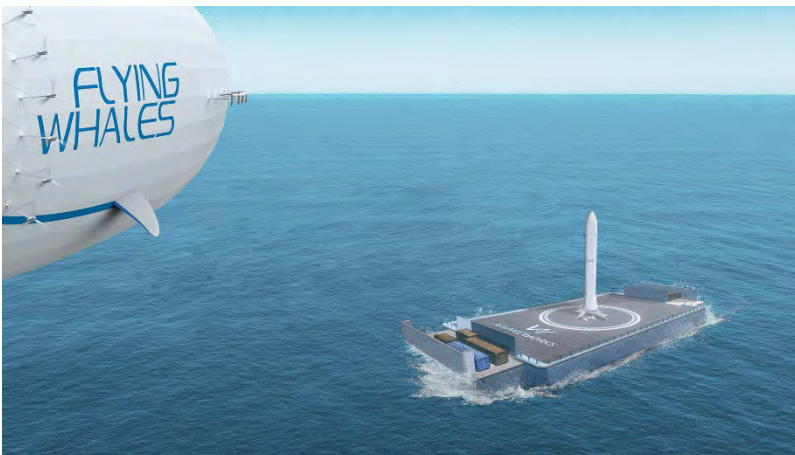

FLYING WHALES

PRODUCTS & SERVICES

The LCA60T is a 200m long and 50m diameter airship able to load and unload hovering. It has the ability to transport the loads inside its cargo bay or under sling. Relying on a hybrid-electric propulsion chain, the aircraft floats in the air thanks to helium.

MAJOR SPACE PROJECTS & REFERENCES

- Study with Ariane Group to recover the future reusable launcher Themis, at sea and bring it back to Spatial Center in French Guiana.
- Use cases with CNES, Ariane and Latitude to transport space material by airship, both in Europe and French Guiana.

POINT OF CONTACT

ADDRESS 13-17 rue Pagès
Suresnes France

WEBSITE www.flying-whales.com

PHONE +33 (0)6 34 25 48 50

POINT-OF-CONTACT : Schalck, Romain, Head of communication

romain.schalck@flying-whales.com, +33 (0)6 34 25 48 50

TURNOVER

WORK FORCE 140 employees

SPACE TURNOVER

SPACE WORK FORCE

Transversal competencies



GAEL Systems is a French SME developing innovation software solutions to facilitate the access to Earth Observation (EO) data.

COMPETENCIES & CAPABILITIES

Our core skills are articulated around three main activities:

- Software development and maintenance for data archiving, dissemination, traceability.
- Software development and maintenance for data quality control.
- Cloud-based platform operations.



GAEL Systems

PRODUCTS & SERVICES

- Elastic Node Server (ENS): API allowing you to access the data in any EO product and extract the smallest info (pixel level for optic images) without downloading the whole product.
- Amalfi: quality control suite of tools used on ESA S1 and S2 PDGS.
- Gael Store Service (GSS): micro-services allowing the archiving, the discovery and the dissemination of EO data.
- Cloud-based big data platforms operations.

MAJOR SPACE PROJECTS & REFERENCES

- Data Hub Software – ESA - <https://scihub.copernicus.eu/>
- ONDA Data and Info Access Service- ESA/European Commission - <https://www.onda-dias.eu/cms/>
- Traceability and Data bridge services – Copernicus Space Component – ESA - <https://trace.gael-systems.com/>
- Deepcube (Horizon 2020) – European Commission - <https://deepcube-h2020.eu/>
- Sentinel-1 and Sentinel-2 Online quality control - ESA

POINT OF CONTACT

ADDRESS 25 rue Alfred Nobel
77420 Champs sur Marne France

WEBSITE www.gael-systems.com

PHONE +33 (0)1 64 73 99 55

POINT-OF-CONTACT : Benamara Amèle, Sales manager
amele.benamara@gael.fr, +33 (0)7 68 60 86 30

TURNOVER 2 M€

WORK FORCE 23 employees

SPACE TURNOVER 2 M€

SPACE WORK FORCE 23 employees

Transversal competencies



Gama builds deployable space structures to allow infinite propulsion through solar sails and sustainable use of Space through drag sails.

COMPETENCIES & CAPABILITIES

- Solar sail propulsion
- Navigation in the Solar system
- Large deployable structures in space
- Drag sails



GAMMA

PRODUCTS & SERVICES

Gama enable large deployable space structures, focusing on two axes:

- Thanks to low-cost, reliable and scalable solar sails, we are redefining deep space access. Our line of spacecraft allows new missions previously considered too expensive or complex to launch.
- As regulations are changing towards stricter requirement for satellite end-of-life, Gama is offering an efficient and simple solution to deorbit safely and autonomously spacecraft after their mission using drag sails.

MAJOR SPACE PROJECTS & REFERENCES

Alpha is the first solar sail of the company Gama. Launched in January 2023 at an altitude of 550km with a solar sail of 73m².

Astrobrake is the dragsail product line of the company. Built to be reliable and autonomous from spacecraft subsystems, it allows easy compliance with new regulations. First flight is planned for 2025.

POINT OF CONTACT

ADDRESS L7 – 128 bis avenue Jean Jaurès
94200 Ivry-sur-Seine
France

WEBSITE www.gamaspace.com

PHONE +33 (0)6 65 64 39 86

POINT-OF-CONTACT : Andrew Nutter, CEO of Gama

andrew@gamaspace.com, 06 65 64 39 86

WORK FORCE 15 employees

Transversal competencies



Geo4i is a French company specialized in image intelligence and geospatial analysis in the fields of Defense, Security and Safety.

Its main objective is to democratize access to spatial imagery as well as everything related to image analysis processing.

COMPETENCIES & CAPABILITIES

Geo4i's activity is based on 5 areas:

- **The supply of space imagery:** offering the best images to its customers through a partnership with the main image suppliers on the world market (optical, multispectral, radar, video, 3D products, AIS, ADSB...).
- **Consulting:** technology watch, software, systems audit, project management assistance and customer support.
- **GEOINT and IMINT Training:** from initiation to expertise in France and abroad: geographic and geomatic information, imagery (optical, infrared and radar), geospatial intelligence.
- **GEOINT and IMINT Production:** production of IMINT and GEOINT intelligence reports.

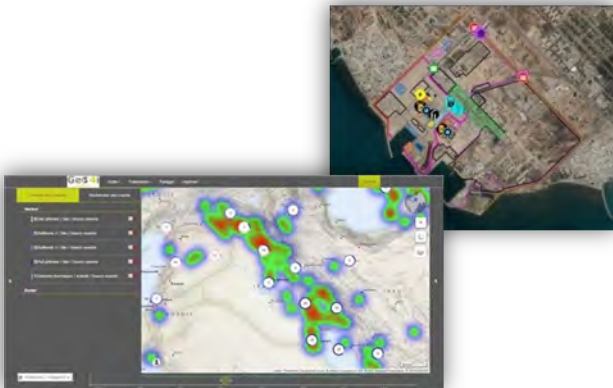

Geo4i

PRODUCTS & SERVICES

Geo4i has developed a **geospatial platform GEOSPACE** to ensure its IMINT and GEOINT productions. GEOSPACE is a collaborative platform dedicated to the integration, exploitation, visualization, analysis and sharing of geolocalized and temporal big data from multiple sources. It integrates all types of geolocalized data: in space and in time, which allows Geo4i to perform different types of applications.

Various tools linked to this platform have been developed:

- **Help4i**: help in equipment identification
- **Site4i**: vectorization of elements of interest in the platform. Storage and sharing of analyzes.
- **Automatic processing**: detection of human activity (coherence map), automatic detection of active fires, off-shore elements...
- **Artificial Intelligence**: AI chain allowing the creation of detection models.
- **Dashboard**: AI detector results
- **MAGIC**: Automatic correlation tool

MAJOR SPACE PROJECTS & REFERENCES

References:

Imagery and IMINT training in France and abroad
Resell of satellite imagery
Labelling of element of interest on satellite imagery
Production of IMINT and GEOINT reports
Deployment of our solutions (Geospace, Help4i...)

Customers:

CNES ; French Ministry of Defense ; Foreign Ministry of Defense ; Security and defense services companies; Capgemini ; Airbus Defense & Space ; Thales Alenia Space ; FRS ; IRT Saint Exupéry ; Thales Sixt

POINT OF CONTACT

ADDRESS 60 quai d'Amont, Creil
60100 France

WEBSITE www.geo4i.com

PHONE +33 (0)9 72 55 00 91

POINT-OF-CONTACT KERRELLO, Lionel, CEO
lionel.kerrello@geo4i.com, +33 (0)672915344
MERMET, Audrey, Sales Assistant,
audrey.mermet@geo4i.com, +33 (0)621602180
REUX, Jeff, Deputy Director
jeff.reux@geo4i.com, +33 (0)650927491

WORK FORCE 9 employees

Transversal competencies



Geomatys: Geodata intelligence leads your decisions.

Geomatys has strong technical expertise in the field of standardisation and develops cutting-edge technical solutions to promote geospatial interoperability.

Much more than an IT service company, Geomatys edits its own geospatial environment.

COMPETENCIES & CAPABILITIES

We build our own software solutions for processing geospatial information. We aim at combining the advantages of Open Source software and the specific needs of commercial applications within the same technical environment. Custom development has always been at the heart of Geomatys business. We have been building geospatial information applications for clients around the world since 2005. Geomatys has strong technical expertise in the field of geospatial standardization and develops cutting-edge technical solutions to promote geospatial interoperability. We are involved in international standardization process. We have strong expertise in spatial reference system, terrestrial or extra-terrestrial.

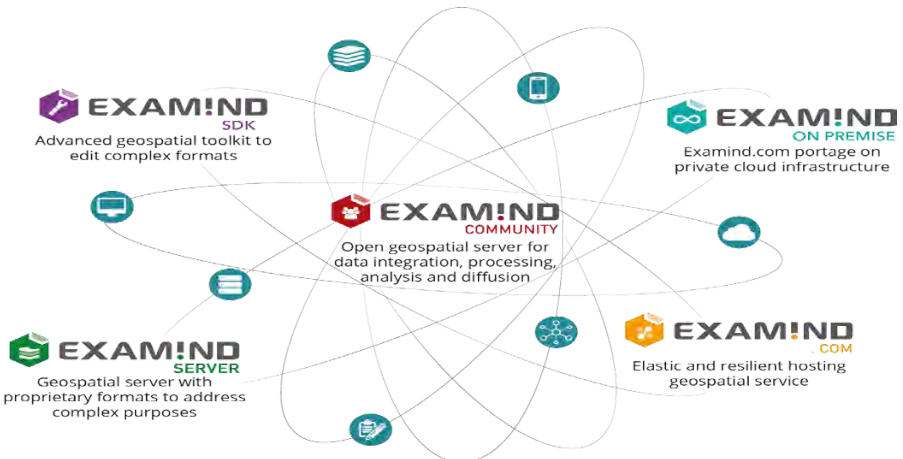

GEOMATYS

PRODUCTS & SERVICES

Geomatys has developed geospatial information applications for clients around the world since 2005, based on open source or commercial softwares. Geomatys commercial products are:

EXAMIND SDK: brings a set of software components allowing the development of advanced functionalities related to the reading/writing, processing and display of georeferenced data. It can be used as an additional component of an existing Java development project.

EXAMIND for server: brings a set of advanced GIS functionalities:

- formats: ECW, JPEG 2000, Radarsat, Spot 7, Electronic Navigation Charts, 3D Cesium,
- client-specific distribution services,
- clustering service: for better load distribution,
- web Sensor Infrastructure for the use of connected objects.

EXAMIND on premise: is a set of services that allows the end-to-end development of a geospatial Cloud solution. This allows the distribution and analysis of Big Data. This solution provides all the deployment, administration, and monitoring advantages of a resilient solution and makes the most of the unrestricted load-increase capacity.

MAJOR SPACE PROJECTS & REFERENCES

- Geosud Spatial Data Infrastructure (Geosud, SEAS-OI, AGEOS)
- Reflecs Geospatial Catalogue (CNES),
- Marine surveillance system (RESTEC/Japan),
- Earth data Catalogue (Australia),
- Geospatial Defense Project (C4ISR)

POINT OF CONTACT

ADDRESS 24 rue Pierre Renaudel
F-13200 - Arles - France

WEBSITE www.geomatys.com

PHONE +33 (0)4 84 49 02 26

POINT-OF-CONTACT: CONTACT Vincent Heurteaux
vincent.heurteaux@geomatys.com

TURNOVER > €1m

WORK FORCE 16

SPACE TURNOVER > €400k

SPACE WORK FORCE 13

Orbital systems
Transversal competencies



Gisaia is a geospatial intelligence company. It offers geospatial technology solutions and services for massive geodata to support data-driven decision making. This primarily relies on Gisaia's solution, ARLAS®. ARLAS is an open-source framework built upon cutting-edge big-data technologies. It facilitates analytics and exploration of diverse geospatial data.

Gisaia offers innovative geo-analytics solutions to help adopters strengthen their market positions.

COMPETENCIES & CAPABILITIES

- Geospatial data platform development - ergonomic interfaces, dashboards, widgets and data visualisation
- Big data technologies - platform scalability
- Geo-analytics - data cubes
- Data processing - Spark & dask on Copernicus, Landsat, Pleiade, NetCDF & zarr, AIS tracks
- Data science - Machine learning and algorithms
- Cloud computing - user access and security
- Open source - OGC compliance



Screenshot of ARLAS-EO

GISAiA

PRODUCTS & SERVICES

1. **ARLAS-EO**: market ready solution for building scalable, multi-source Earth observation data catalogues.
2. **ARLAS Framework**: An open-source development kit for creating geo-data platforms, applicable for multiple use-cases.
3. **ARLAS Cloud**: A scalable cloud environment fully adapted for geo big data analytics with ARLAS running and maintained by the team that published it.
4. **Gisaia professional consultancy and services**: support, training, software development, geodata processing to make it analytics-ready and general geospatial intelligence services.

MAJOR SPACE PROJECTS & REFERENCES

- Earth observation products catalogue builder: Multi-collection products catalogues like, Theia catalogue, Dinamis catalogue and others - owned by CNES and IRD, Airbus Defence and Space
- Earth observation data analytics: DominoX project - ESA, CNES, Airbus Defence and Space
- Spatial data pre-visualisation: GRASP

POINT OF CONTACT

ADDRESS 2 avenue de l'Escadrille Normandie Niemen
31700 Blagnac, France

WEBSITE www.gisaia.com

POINT-OF-CONTACT : Laurent DEZOU, CEO
laurent.dezou@gisaia.com

Dolphine RAMBAUD, VP for Branding
dolphine.rambaud@gisaia.com

contact@gisaia.com

SPACE WORK FORCE 10 employees

- Orbital systems
- Launchers
- Satellites
- Ground segments
- Space planes
- Transversal competencies



GMV is a private engineering and technology group, being one of the strongest players in the Space domain. It is a premier provider worldwide for space organizations and agencies, and the major satellite manufacturers and operators.

COMPETENCIES & CAPABILITIES

With over 35 years of experience behind it and nearly 500 satellites carrying its technology, GMV can safely claim to be a technological partner of cast-iron dependability, capable of meeting the most stringent needs under the strictest quality standards. It had achieved CMMI Level 5 certification, covering the whole range of activities and services within the Space sector.



PRODUCTS & SERVICES

GROUND SEGMENT: Design and integration of complete ground segment, Satellite control centers, Flight dynamics systems, Mission planning systems, Ground Stations Monitoring and Control, Fleet Management, Automation, Security Facilities, Networks and cybersecurity, Payload configuration, planning and optimization, systems, EO and Science mission operations centers.

FLIGHT SEGMENT: System-engineering and mission analysis, GNC systems, Autonomy and robotics, Satellite and mission simulators, Ground validation and testbeds, Onboard SW, ISVV, data simulator and processor prototypes for EO and Astronomy instruments.

NAVIGATION: Engineering and algorithms of satellite navigation systems, Major systems of processing and generation of GNSS signals, Precise positioning solutions and augmentation systems, Timing and PPP services.

DATA PROCESSING: Instrument processors for EO and Science missions, calibration systems, Space applications, solutions and services (e.g. security, land, agriculture, forestry, maritime,...)

MAJOR SPACE PROJECTS & REFERENCES

CNES: GMV is a framework-contract supplier of CNES's systems and services, contributing to the development and maintenance of the orbital dynamics systems used by this agency, including the next-generation SIRIUS system. GMV is performing studies and developments in the domain of Space Surveillance and Tracking and Orbital Collision Management as well as Onboard software developments especially related to autonomous navigation.

EUTELSAT: GMV is the main supplier for the ground segment of Eutelsat's satellite fleet, including the satellite control center, flight dynamics systems, ground stations monitoring and control, network and access security and payload management and configuration.

ESA: After more than 35 years of collaboration, GMV has become one of the main suppliers of ESA and has provided its specialist services and solutions for almost all of ESA's missions at any of the operating centers (ESOC, ESTEC, ESRIN, EAC, ESAC, ECSAT).

ADDRESS: 17 rue Hermès, PAT Canal
31250 Ramonville-Saint-Agne, France

WEBSITE: www.gmv.com

PHONE: +33 (0)5 34 31 42 61

POINT-OF-CONTACT: Juan PEREZ - Director France - japerez@gmv.com

TURNOVER: 243 M€

WORK FORCE: 2000

SPACE TURNOVER: 142 M€

SPACE WORK FORCE: 1020 (30 in France) – rank# 6 in Europe

Transversal competencies



Generalized Retrieval of Atmosphere and Surface Properties (GRASP SAS) is a start-up created in 2015 with the main goal of development of remote sensing algorithms and scientific methods for environment studies of atmosphere and surface of the Earth. GRASP SAS has been involved in collaboration with world-wide environmental public organizations and private companies, universities and the largest space agencies (ESA, EUMETSAT, NASA, JAXA).

COMPETENCIES & CAPABILITIES

The main GRASP SAS activities cover a wide range of remote sensing topics:

- Developments of algorithms for advanced atmosphere and surface characterization from passive and active ground based and space-borne remote sensing.
- Earth science data production and distribution.
- Scientific consulting in environmental studies.
- Services related to distribution and support of activities related with remote sensing GRASP open source software that GRASP SAS supports and develops.

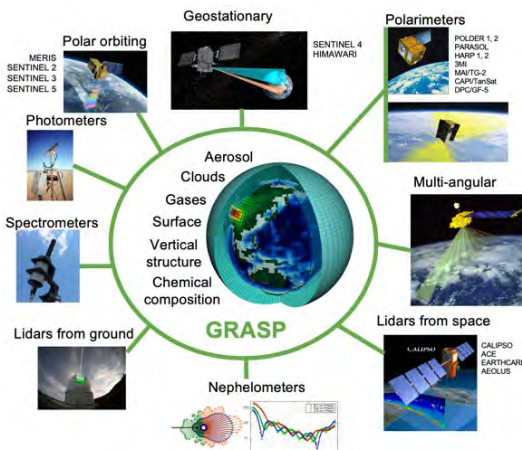

GRASP SAS

PRODUCTS & SERVICES

Generalized Retrieval of Aerosol and Surface Properties (GRASP) is a highly accurate aerosol retrieval algorithm that processes properties of aerosol- and land-surface-reflectance. It infers nearly 50 aerosol and surface parameters including particle size distribution, the spectral index of refraction, the degree of sphericity and absorption. The algorithm is designed for the enhanced characterization of aerosol properties from spectral, multi-angular polarimetric remote sensing observations. GRASP works under different conditions, including bright surfaces such as deserts, where the reflectance overwhelms the signal of aerosols. GRASP is highly versatile and allows input from a wide variety of satellite and surface measurements.

GRASP is an open source code available on <https://www.grasp-open.com>

MAJOR SPACE PROJECTS & REFERENCES

GRASP is an official Day 1+ algorithm for future 3MI mission.

GRASP is involved with EUMETSAT in the development of aerosol retrieval from Sentinel-3 OLCI observations.

GRASP is a part of the ESA operational algorithm for aerosol and surface from Sentinel-4 observations.

GRASP is involved with EUMETSAT in the development of aerosol and surface retrieval algorithm for of Sentinel-5p mission.

GRASP has been applied successfully for processing of full archives of data from POLDER-1, -2 and -3 and MERIS/ENVISAT missions, the results are publicly available at <https://www.grasp-open.com/products/>

List of GRASP related papers: <https://www.grasp-open.com/publications/>

POINT OF CONTACT

ADDRESS 20 Impasse de l'Eglise
59830 Bachy, France

WEBSITE www.grasp-sas.com

PHONE +33 (0) 7 86 80 51 80

POINT-OF-CONTACT FUERTES David, CEO, david.fuertes@grasp-sas.com

TURNOVER 0,6 M€

WORK FORCE 8 employees (incl. 7 PhD in Physics)

SPACE TURNOVER 0,45 M€

SPACE WORK FORCE 8 employees

Ground segments
Transversal competencies



Greenerwave develops next generation of *Ground user Terminals* for on the pause and on the move applications.

Our flat panel antennas are electronically steered, with no moving parts. From academic background, Greenerwave has a disruptive and patented beamforming technology to unlock multi-orbits broadband connectivity: high efficiency, low power and competitive.

Available in Ku and Ka bands our terminals will next be in Q/V band.

COMPETENCIES & CAPABILITIES

- Ground user terminals
- Radio Frequencies (X, Ku, Ka, Q and V bands)
- Wave physics and propagation
- Reconfigurable intelligent surfaces

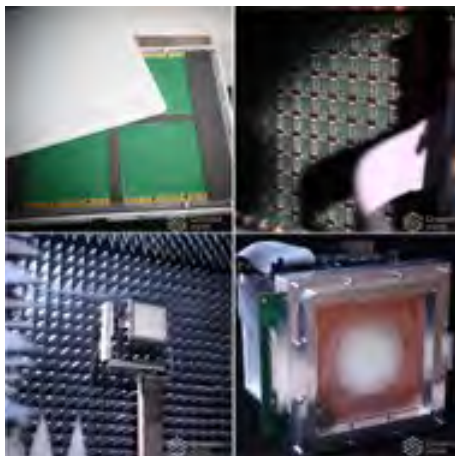

Greenerwave

PRODUCTS & SERVICES

Greenerwave is developing Ground user terminals for satellite broadband connectivity.

User terminals are available in Ku and Ka band with the following attributes:

- Full duplex, Single aperture,
- Low power,
- Flat panel, Electronically steered with no moving parts,
- Multi-bands,
- Multi-orbits,
- Multi-beams
- ...

MAJOR SPACE PROJECTS & REFERENCES

Greenerwave is working with the French Defense Agency and the CNES on large project to develop next generation terminals. Part of the plan de Relance and France 2030.

With 40 engineers (mid year 2022)

POINT OF CONTACT

ADDRESS 35 rue du Sentier

75002 Paris, France

WEBSITE www.greenerwave.com

PHONE +33 (0)1 42 36 73 20

POINT-OF-CONTACT : Geoffroy Lerosey, cofounder

WORK FORCE 40 employees

SPACE TURNOVER 3 M€

SPACE WORK FORCE 20 employees, growing fast

Launchers
Satellites
Ground segments
Transversal competencies



With three decades of experience in these fields, Groupe ADF has profoundly integrated sustainability and innovation in its solutions.

For production purpose, these solutions are based on a general Industry 4.0 approach and digital technology suit such as innovative automation, collaborative “man-robot” work and smart data management.

For specific test and industrial devices, we develop solutions according to client requirements. We then provide the most effective cost efficiency for the solutions we design, produce and maintain.

COMPETENCIES & CAPABILITIES

Groupe ADF has provided solutions to Space Industry to improve the value of the products and the services of all its clients. Our teams are covering engineering design, development and construction of production means, specific metrology, complex test and industrial devices, maintenance and exploitation of plant.



GROUPE ADF

PRODUCTS & SERVICES

In order to support our customers with integrated solutions, our teams are involved in all phases of a project. From the design to the implementation and maintenance of a solution, our service offer extends to the modernization and upgrading of equipment.

Our solutions can be divided into 7 services: Engineering, Supply chain, Production fabrication and integration, Commissioning support, Production and maintenance services, Modernization & Environmental rehabilitation.

Basically, we provide our clients a vision of the global impact of ownership of their assets and optimized it.

MAJOR SPACE PROJECTS & REFERENCES

- OWEB production lines (including MES)
- ARIANE 6 LAUNCH VEHICLE production lines (Europe & Kourou)
- French GUYANA LAUNCH PADS Maintenance and Exploitation
- ARIANE 4/5/6 Launch Pad Cryotechnics Interfaces
- TARANIS / MERLIN / MICROSCOPE / MICROCARB Satellite Structure Design & Built
- Ariane 5 BOOSTER THRUST Measuring Device
- DUMMY A6 BOOSTER (SCALE 1)
- MECHANICAL and THERMAL satellite studies
- JIG/TOOLS/MGSE & SPECIFIC TRANSPORTATION means

POINT OF CONTACT

ADDRESS ZI La Bastide Blanche, Bat G
13127, Vitrolles France

WEBSITE www.groupeadf.com

PHONE +33 (0)4 42 77 48 50

POINT-OF-CONTACT Armando PEREZ International Sales Director
Gilles TRIAY Head of Technology Segment
contagt@groupeadf.com

TURNOVER 460 M€

WORK FORCE 3700

Ground segments
Transversal competencies



GUIDE is a Testing Laboratory specialized in GNSS, implementing and providing all types of services intended to assess, validate and certify geolocation performance of critical functions used by ITS applications.

COMPETENCIES & CAPABILITIES

GUIDE covers 3 types of competencies:

- 1- METROLOGY: Specification of methods, Performance of measurement campaigns, Interpretation of the collected data to deliver reliable numerical outcomes with managed certainties.
- 2- GEOLOCATION: Expertise in precise positioning solutions based on GNSS technologies.
- 3- CRITICALITY: Identification of feared situations, risk ranking and evaluation of the occurrence of phenomena



GUIDE

PRODUCTS & SERVICES

Test engineering (E) Test Report « Certifications »

- Test specification
- Test planning
- Performance of the tests (Live testing, Simulation, Replay)
- Data processing and analysis
- Test Report

Test facility engineering (M) Test Scenarios and Analysis Tools

- Definition of test facilities
- Design, development and distribution of test scenarios
- Design, development and distribution of test tools
- Training

Performance engineering (P) R&D study and technical consulting

- Assistance to implement GNSS technologies
- Assistance to mastery of work
- Research and Development studies

MAJOR SPACE PROJECTS & REFERENCES

R&D contracts

- CNES : SPRING v2, SPRING 3D, BSAB, APPP, GEOFER, R&R1, R&R2, VEDECOM, GIMU
- ESA : HISTB2, GUEST, HDGNSS // GSA : JUPITER // SHIFT2RAIL : GATE4RAIL

Legal Metrology

- ECOMOUV : Projet Ecotaxe
- CEN/CENELEC : GPSTART1, GPSTART2

Industry

- ACTIA: ROLLOVER, TGW3 // - CONTINENTAL :GX01
- AIRBUS DS: NECT // - THALES: Rxl
- M3 SYSTEMS: ATLANS // - NAI0: ASTUS NR3

Subsidized Projects

- BPI /FUI: Path4Flight / DIRECCTE: REALOC
- OCCITANIE REGION: GEOFER, IQDATA
- NOUV. AQUITAINE REGION: KAPILARRA

POINT OF CONTACT

ADDRESS 3, avenue Didier Daurat – 31400 Toulouse - France

WEBSITE www.guide-gnss.com

PHONE +33 5 62 80 82 58

POINT-OF-CONTACT LEBLAN Xavier, Directeur
+33 6 87 60 70 91 / xavier.leblan@guide-gnss.com

WORK FORCE 4

SPACE TURNOVER 0,35 M€

SPACE WORK FORCE 4

Satellites
Transversal competencies



L3Harris Geospatial is the world leader in image science software and supporting technologies. Our products have helped scientists explore space, see the human body in new ways, and understand the world around them. Today, our customers rely on our in-depth knowledge of advanced geospatial analytics, big data management technologies, and remotely sensed data, along with a highly tuned process for applying deep learning to deliver value across a variety of industries.

COMPETENCIES & CAPABILITIES

ANALYTICS

L3Harris Geospatial's work in analytics can be traced back to 1977, when we developed Interactive Data Language (IDL) at the University of Colorado to support the Mariner Mars 7 and 9 space probes. Since then, we have stayed true to our origins of relying on scientifically proven analytics to create industry leading solutions that extract information from all types of remotely sensed data. Our software solutions support all of the latest data collection platforms (satellites, airborne, drone, terrestrial), more than 200 different types of data, and different modalities including panchromatic, multi and hyperspectral, LiDAR, SAR and FMV.

DEEP LEARNING

We have developed a highly tuned AI process, relying less on the volume of label data and more on reliable training models and high-performance computing, that allows us to solve real-world problems quicker and more cost effectively than ever before.

CONTENT MANAGEMENT

We have developed the solutions that make it easier and more profitable for our customers to access, manage, and share all this geospatial content. As geospatial content is consolidated and unified, L3Harris technology enables users to anticipate future enrichment, enhancement, and maintenance of the content in support of planned and unplanned missions.

L3HARRIS GEOSPATIAL

PRODUCTS & SERVICES

- ENVI is the industry's leading image science software that enables users to extract actionable information from geospatial data to make more informed decisions. Businesses and organizations choose ENVI because it integrates with existing workflows, supports today's most popular sensors, and can easily be customized to meet unique project requirements.
- ENVI SARscape is used to process and analyze SAR data acquired from all existing spaceborne and selected airborne platforms, taking the data from hard-to-interpret numbers and turning it into meaningful, contextual information. ENVI SARscape generates products and offers the option to integrate this information with other geospatial products.
- Custom Solutions –The L3Harris Solutions Delivery team has extensive experience handling data in many complex formats from a variety of commercial, scientific, and government sources. This team of scientific programmers can build custom, commercial-grade applications, data processing workflows, and productivity tools that will meet any geospatial data software need.

MAJOR SPACE PROJECTS & REFERENCES

The following organizations have been using our technology:

- European Space Agency (ESA)
- German Aerospace Center (DLR)
- French National Centre for Space Studies (CNES)
- Italian Space Agency (ASI)
- South African National Space Agency (SANSA)
- eGeos
- Thales Alenia Space
- Airbus Defence and Space
- UNOSAT
- HISDESAT Servicios Estrategicos S.A.

POINT OF CONTACT

ADDRESS Tour de l'Horloge - 4 place Louis Armand
75603 Paris Cedex 12
France

WEBSITE www.l3harrisgeospatial.com

PHONE +33 (0) 1 73 02 46 20

POINT-OF-CONTACT Belaidi, Ahmed
Sales Manager France
ahmed.belaidi@l3harris.com
+33 (0) 1 73 02 46 18

Orbital systems

Satellites

Transversal competencies

HEATSELF

HEATSELF is an industrial SME specialized in the development and production of thermal solutions.

HEATSELF employs electrically conductive polymers with PTC (Positive Temperature Coefficient) effect able to emit heat using the surrounding temperature without using any electronic control system.

COMPETENCIES & CAPABILITIES

The material used to for the HEATSELF products is thermo-sensitive and is able to dilate or contract depending on the surrounding temperature. This result is obtained thanks to HEATSELF's know-how in the production of polymers with an electrical impedance varying with temperature. The advantage of using HEATSELF's technology for industrial applications is the use of materials able to adjust the amount of energy needed to maintain industrial processes. In order to monitor R&D and production, HEATSELF set up an electro-thermal characterization laboratory and a performance test bench to assess products over time. HEATSELF now also has the necessary tools to simulate temperature variations in a climatic chamber.



HEATSELF

PRODUCTS & SERVICES

HEATSELF offers different types of self-regulating heating components, cable solutions, foils, wire for industry applications.

Heating cables that are commonly used to prevent frost or low temperature in pipes to avoid ice. They can be cut to length.

The self-regulated heating cable has to managed itself its power. For this reason, the cable must have a PTC (Positive Temperature Coefficient) effect: The electrical resistance increases with the temperature so power decreases when temperature increases.

This technology has been chosen to eliminate all regulation systems and electronics.

Benefits: Substantial competitiveness gain is expected from this technology, quite reduced efforts for propellant line on ATC, thermal design, integration and procurement.

MAJOR SPACE PROJECTS & REFERENCES

FSRH, Flexible Self Regulating Heating cable: Program with ESA and Thales Alenia Space in pre-development of NEOSAT.

DISTRIBUTED THERMAL SENSOR: Invitation to Tender (ITT) followed by TDE with ESA 2019: a demonstrator of a new type of smart temperature sensor, this system will provide a continuous temperature profile, richer in thermal information by TDR, Time Domain Reflectometry. HEATSELF designs thermosensitive polymer materials. Also HEATSELF manufactured a specific heater for propellant line of satellite 1W @0°C and 0.1W @40°C under 100Vdc.

R&T CNES, 2D self-regulated flexible heater for satellite equipment: feasibility followed by de-risking program TRL 5 maturity in progress (2024).

POINT OF CONTACT

ADDRESS HEATSELF, N 181 ZI Les Aulnaies, 76680 Saint Saens, France

WEBSITE www.heatself.com

PHONE +33 (0)2 35 34 21 45

POINT-OF-CONTACT : PAUL BERT, Philippe, CTO, ppaulbert@heatself.com

Mobile +33 (0)6 30 58 21 56

TURNOVER 0.7 M€

WORK FORCE 4

SPACE TURNOVER 0.3 M€

SPACE WORK FORCE 2

Satellites
Transversal competencies



HEMERIA is a young company drawing on a 30-year heritage of Defence and Space expertise, that conceives and manufactures high-dependability, high- tech equipment and systems for the very exacting requirements of the Space industry and France's nuclear deterrence force.

A renowned major player in the space industry, HEMERIA designs, supplies, integrates, and enables state-of-the-art space systems and products that meet the needs of its commercial, for the major European and international programmes.

COMPETENCIES & CAPABILITIES

HEMERIA develops integrated sub-assemblies, systems and equipment, including composites, multi-layer insulation (MLI), harnesses, flight circuit boards, machined parts, embedded electronics, complete satellite or optical instrument structures, satellite batteries, antennas, power management equipment and mechanisms.

HEMERIA operates in the fields of telecommunications, Earth-observation, science and navigation satellites, and have built up an impressive record in constellations (such as IRIDIUM NEXT); supplying also harnesses for launchers and satellite dispensers, as well as serving nuclear and military applications.

- HEMERIA is the European leader in the design, sizing, production, testing and integration of embedded harnesses for satellites and launchers.
- HEMERIA also develops its own range of nano-satellites, giving to non-experienced professionals, fast, competitive and effective access to space.



HEMERIA

PRODUCTS & SERVICES

HEMERIA's offer primarily comprises 5 complementary product lines:

- Power/control-command flight harnesses and RF harnesses,
- Aluminum or carbon composite structures (sandwich panels or monolithic parts),
- Active and passive thermal control subsystem,
- Assembly, Integration and Testing of whole or complex subsystems and embedded equipment.
- Nano-satellites platforms.

MAJOR SPACE PROJECTS & REFERENCES

- **SMALL SATS HEMERIA@:** A range of small highly reliable platforms (from 3U to personalization), from 10kg to 50kg. They are accessible to non-experienced professionals who are eager to take advantage of fast access to space that is both highly competitive and efficient.
- **IRIDIUM NEXT:** In 2012, after a tough worldwide competition, HEMERIA was awarded production of the harnesses and composite panels for all 81 IRIDIUM-NEXT satellites. Offering proposals with particularly innovative solutions, HEMERIA knew how to win customer over in its final decision.
- **METOP SG:** HEMERIA won METOP SG SAT-A and SAT B platform harnesses under a build to spec approach. This activity includes design, manufacturing, tests, and integration of 6 flight models from 2017 to 2023 for Airbus Defence and Space.
- **GEO-NG:** According to HEMERIA heritage on 4 satellites AS1000 structures and harnesses between 2015-2016, HEMERIA won 4 complete satellites structures flight harnesses, instrument MLI, and AIT on GEO-NG project for Airbus Defense and Space.
- **ARIANE 5:** Since beginning of 90's HEMERIA manufactures and tests Vehicle Equipment Bay (VEB) harnesses on Ariane 5 launcher.

POINT OF CONTACT

ADDRESS 8 impasse Boudeville

F-31100 - Toulouse

WEBSITE www.hemeria-group.com

PHONE +33 (0)5 82 95 16 22

POINT-OF-CONTACT : Nicolas Multan / Jean-Michel Gouzenes

nicolas.multan@hemeria-group.com

jean-michel.gouzenes@hemeria-group.com

TURNOVER > €25m

WORK FORCE 200

SPACE TURNOVER €15m

SPACE WORK FORCE 110

Balloons
Transversal competencies



Hemeria Airship is a European key player in aerostat systems, whether tethered, stratospheric or dirigible and one of the main French suppliers of thermal protection for satellites.

Building on a 50-year heritage and a 9,500 m² industrial site, our offer is aimed at the innovative and demanding markets of defence, security and space.

Hemeria Airship is a subsidiary of Hemeria group.

COMPETENCIES & CAPABILITIES

Hemeria Airship benefits from a unique industrial tool:

- 9,500 m² dedicated to lighter than air technologies and thermal protections, including a 700 m² ISO 8 clean room
- 5 production lines, including one line of 200 meters long
- A quality management system EN9100 certified

Which is combined with niche aerospace skills:

- Aerostat design and sub-systems
- Flexible and complex materials expertise
- Tight assembly techniques
- Innovative industrial methods and processes
- Airworthiness
- Aerostat deployment and operations



MLI - multi-layer insulation



Stratospheric balloon

HEMERIA AIRSHIP

PRODUCTS & SERVICES

Our business lines:

- Historical niche manufacturing for the space industry:
 - Stratospheric balloons
 - Thermal insulations for satellites
 - Zero-gravity balloons
- Systems for the protection of states, goods and people:
 - Surveillance and communication tethered aerostat systems
- Innovative developments for green aviation and New Space:
 - Drone airships
 - Innovative aerostat envelopes and sub-systems

MAJOR SPACE PROJECTS & REFERENCES

Among our customers: CNES, Thales, Airbus, French ministry of defense, French ministry of the interior, SSC, Onera, RTE

Hemeria Airship benefits from the trust of major international accounts:

- Long-term industrial partner of CNES for stratospheric balloons
- Awarded by the French “France Relance” program to develop a new type of stratospheric balloon: the maneuvering balloon.
- More than 100 satellites or space vehicles equipped with our thermal protections

POINT OF CONTACT

ADDRESS 2 chemin de la Val Priout, ZA Labal Priout

31450 - Ayguesvives - France

WEBSITE www.hemeria-group.com/

PHONE +33 (0)5 34 43 04 09

POINT-OF-CONTACT Cyril BAKIR, sales manager Hemeria Airship

TURNOVER €10M

WORK FORCE 70

SPACE TURNOVER



HENSOLDT SPACE CONSULTING

Transversal competencies

Since 2006, HENSOLDT SPACE CONSULTING supports space actors in the development of orbital systems by providing them solutions and guidance on their technologies.

COMPETENCIES & CAPABILITIES

HENSOLDT SPACE CONSULTING develops 3 activities in the space sector.

- We carry out all product assurance and quality assurance activities during all phases of yours projects from design to integration and we propose rapid progress of your space systems.
- We contribute to the system and technological expertise of products/system/subsystem
- We support your teams by providing organizational, technical and technological solutions throughout the cycle of your projects



HENSOLDT SPACE CONSULTING

PRODUCTS & SERVICES

- Product Assurance Hardware & Software
- System expertise
- Space qualification
- Management consulting

MAJOR SPACE PROJECTS & REFERENCES

More than 50 space missions (planetary, earth observation, meteorological, astronomy, launchers, ...).

DRAGONFLY / MMX / ENVISION / ATHENA / ARIEL / COMET INTERCEPTOR / FSS / MSL / MAVEN / INSIGHT / BEPI COLOMBO / SOLAR ORBITER / MSL2020 / EXOMARS / JUICE / CHANGE'6 / CSO / MTG / TARANIS / METOP SG / MERLIN / HERSCHEL / PLANCK / SVOM / EUCLID / PLATO / SOYUZ@KOUROU / ARIANE5 / MYRIADE PLATFORM & NEW SPACE PROJECTS ...

POINT OF CONTACT

ADDRESS 1 Rond-point du Général Eisenhower- Golf Park Bâtiment F
31100 TOULOUSE France

WEBSITE www.hensoldt-space-consulting.com

PHONE +33 (0)6 26 08 70 63

POINT-OF-CONTACT : MAYORDOMO, Nicolas, CEO

nicolas.mayordomo@hensoldt.fr, +33 6 26 08 70 63

TURNOVER 2.2 M€

WORK FORCE 20 employees

SPACE TURNOVER 2.2 M€

SPACE WORK FORCE 20 employees

Launchers
Satellites
Transversal competencies
Balloons



Hionos helps every aircraft manufacturer to build a software Flight Controller meeting most demanding aeronautics embedded software standard (DO-178C), while ensuring cost and time control.

Hionos has been built around the two major skills:

- The ability to develop safety critical, DO-178C software;
- The ability to develop software for drones.

COMPETENCIES & CAPABILITIES

Thanks to our sound experience in safety critical software development for different type of aircraft, we provide manufacturers a mix of process, development environment and already developed software allowing to meet safety regulation objectives (DO-178C) efficiently.

#FlightController

#DO-178C

#Safety

#Autopilot

HIONOS

PRODUCTS & SERVICES

Hionos provides three different products:

1. **Supvareno®**: A process compliant to DO-178C, approved by DGA and Onera;
2. **Pulsar**: A COTS autopilot for drones, compliant to DO-178C;
3. **Pulsar Factory**: A development environment to modify Pulsar.

Our product package allows our customers to choose reusable software bricks and develop the elements specific to their project.

Our development environment ensures a **cost reduction up to 80%** compared to the development of a Flight Controller from scratch and a **reduction of the development duration from 30% to 80%**. Moreover, it will allow small and medium companies to access safety critical market segment that is currently too expensive to reach.

MAJOR SPACE PROJECTS & REFERENCES

CNES : For a project requiring DO-178C compliance, the CNES decided to evaluate Pulsar Factory and Supvareno.

The goal of the project was to set up and deploy a development environment to develop efficiently and in compliance to DO-178C a safeguard equipment reusing previously developed software.

POINT OF CONTACT

ADDRESS 04 Avenue Doyen Louis Weil
Grenoble, France

WEBSITE www.hionos.com

PHONE +33 (0) 6 31 69 18 36

POINT-OF-CONTACT : Brossard, Valentin, CEO
valentin.brossard@hionos.com, +33 6 31 69 18 36

TURNOVER Not Relevant in 2020 (Product Launch)

WORK FORCE 12 people

SPACE TURNOVER

SPACE WORK FORCE

Transversal competencies
Satellites
Orbital systems



Hotblock Onboard develops and manufactures complete thermal control and heat harvesting solutions based on its thermoelectric technologies.

Hotblock Onboard is expert in designing, developing and manufacturing of sub-systems such as Peltier based μ -HVAC for the automotive industry, heat harvesters for Radioisotopic Thermoelectric Generators (RTG) or Peltier coolers for Space applications.

COMPETENCIES & CAPABILITIES

Hotblock Onboard have competencies to design single- and multi-stage thermoelectric devices for both Peltier and heat harvesting modules.

The company has its own fabrication line located in Grenoble (France) to manufacture and test thermoelectric products.

Depending on the customer's applications, we can completely design and produce energy harvesters and thermal control systems including heat exchangers and electronic control boards.

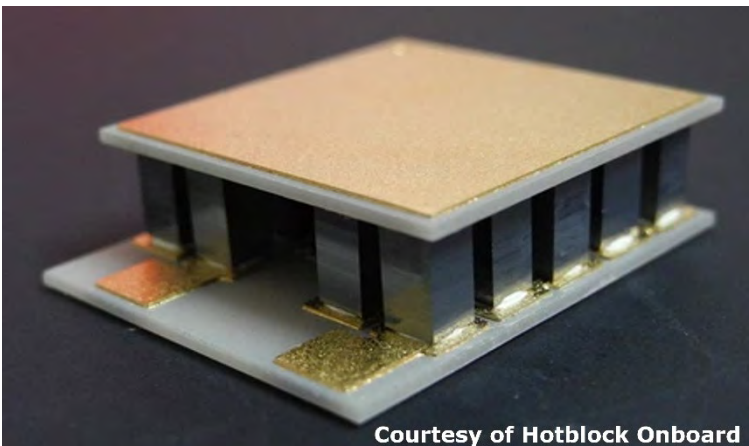

Courtesy of Hotblock Onboard

HOTBLOCK ONBOARD

PRODUCTS & SERVICES

Single- and multi-stage thermoelectric coolers (Peltier modules) and heat harvesters.

Design and thermal modelling of thermoelectric systems.

Complete cooling systems solutions including heat exchangers and electronic control (outside space industry)

MAJOR SPACE PROJECTS & REFERENCES

CNES R&T project on thermoelectric devices.

SODERN's subcontractor in the frame of an activity funded by France Relance investment plan.

POINT OF CONTACT

ADDRESS 43 Chemin du Vieux Chêne
38240 Meylan France

WEBSITE www.hotblock.fr

PHONE +33 (0)4 38 76 00 59 84

POINT-OF-CONTACT : Dufourcq, Joël, Technology Director
joel.dufourcq@hotblock.fr, +33 (0)6 87 01 81 33.

TURNOVER 0.5 M€

WORK FORCE 4 employees

SPACE TURNOVER 0.08 M€

SPACE WORK FORCE 1 employee equivalent.

- Orbital systems
- Launchers
- Ground segments
- Balloons
- Transversal competencies



We are the French leader in human-centered design and HFIP. Born in 1978 as the first consulting spin-off dedicated to the impact of digital on working environments, we designed the global digital transformation of the Air Traffic Control (ATC). Pioneers in user expertise and user-oriented design, we have been at the heart of the design of ambitious products, services, spaces and experiences for 40 years. Independents, we support a majority of large national and international accounts in their transformations.

COMPETENCIES & CAPABILITIES

We bring together a multidisciplinary team of more than 100 consultants; thus bringing together a single coherent and consistent portfolio in human factors integration programs, management and strategic anticipation of innovation, advanced HMI and IUI design, organizational and spatial / interior design. We are at the heart of the human component of all types of complex systems. Addressing the challenges of performance, ease of use as well as security and risk management.



HUMAN DESIGN GROUP

PRODUCTS & SERVICES

We design physical and cognitive environments adapted to the challenges of human-machine interaction with complex systems. This theme covers:

- Development of control rooms and supervision / hypervision spaces, ground segment for constellations monitoring, air traffic control tower);
- Human Factor Integration Program, with a one-stop-shop partnership (from the protocol definition to certification);
- Cybersecurity-oriented digital and organizational transformation;
- Human monitoring systems & ergonomics;
- Cockpit design (aeronautics and defense) and advanced interactions (Intelligent User Interfaces);

Since 2020, we also have developed specific tools and methodologies including a virtual / augmented / Mixed reality platform allowing immersive experiences and evaluation of innovative / prospective projects and contexts of use.

MAJOR SPACE PROJECTS & REFERENCES

Using holistic and human centered approach (melting organization, space and HMI key factors), Human design Group supported CNES on the development of the design referential for its facilities integrating a human component. As a way to secure the design choices and rationale, this tool defines the process of human factor integration throughout the complete lifecycle of CNES programs (Study, project, implementation and operation).

We also have contributed to the ELA 3 Ariane V spaceport program modernization by promoting human factor and ergonomics. We co-designed future work situations with the ELA3 operators (workstation digitization, organizational design).

Collaborating with the CNIM Group, Human design Group developed a unique operational design concept for micro-launchers. Involving our aerospace experts, we responded to various challenges including the operational cost optimization, flexibility, reliability and installation mobility.

POINT OF CONTACT

ADDRESS 7ter rue de la Porte de Buc 78000 Versailles

WEBSITE www.humandesign-group.fr

PHONE +33 (0)1 81 88 15 01

POINT-OF-CONTACT : M. CALVET Guillaume

TURNOVER 11 M€

WORK FORCE 100+

SPACE TURNOVER 3 M€

SPACE WORK FORCE 30+

- Orbital systems
- Launchers
- Satellites
- Ground segments
- Balloons
- Transversal competencies



HYGEOS is a SME created in 2001, specialized in the processing, analysis and validation of Earth Observation satellites data in the optical domain. HYGEOS conducts studies, algorithmic developments and software prototyping, in partnership with research and service institutes. Its main clients are spatial agencies, European institutions, research organizations and industrial companies.

HYGEOS has 12 employees (including 7 PhDs in physics).

COMPETENCIES & CAPABILITIES

In-depth understanding of radiative transfer.

- Expertise and studies in remote sensing: Simulations of the satellite signal, the radiative transfer in the ocean, atmosphere and vegetation in the optical domain, feasibility studies of space missions, in flight calibration, definition of new methods to derive environmental physical variables.
- Scientific algorithms: Definition, modelling and validation of scientific processing chains of Earth Observation data, applications in oceanography, monitoring of continental surfaces, air quality, solar energy.
- Geomatics: Development of multi-source geophysical databases and web portal for data distribution.

MERIS POLYMER composite 3-days (20030321 to 20030323)
59.4% ocean coverage

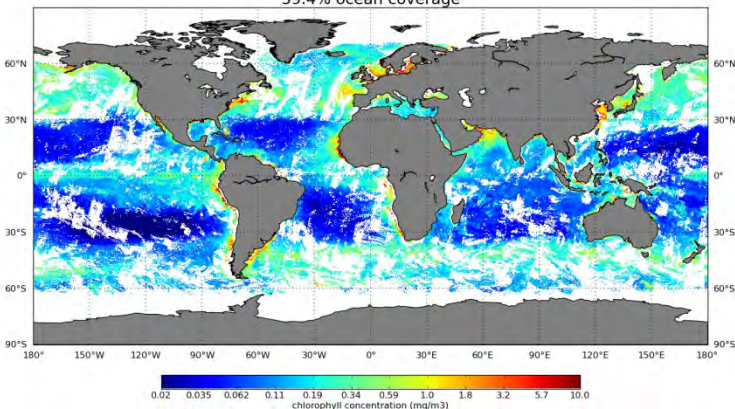

HYGEOS

PRODUCTS & SERVICES

HYGEOS has developed two major tools:

- POLYMER recovers the radiance scattered and absorbed by the oceanic waters (also called Ocean Colour) from the signal measured by satellite sensors in the visible spectrum. It can process multiple sensors like MSI/Sentinel-2, OLCI/Sentinel-3, MERIS/ENVISAT, SeaWiFS, MODIS/Aqua, VIIRS, and GOCI. POLYMER license can be downloaded for free from our Website.
- SMART-G (Speed-Up Monte Carlo Advanced Radiative Transfer using GPU) is an advanced radiative transfer code. It has been co-developed by HYGEOS for CNES to simulate how the light propagates in the atmosphere and ocean.

MAJOR SPACE PROJECTS & REFERENCES

HYGEOS is strongly involved in Copernicus services: i) leading the global aerosol project of Copernicus Atmosphere Monitoring Service; ii) coordinating the scientific activities related to the "Vegetation and Energy" variables of the Global Land Service; iii) carrying out atmospheric correction of 3 Essential Climate Variables for the Climate Change Service. HYGEOS has recognized expertise in monitoring the biological activity of the oceans, through the quantitative estimation of the optical and physical properties of the sea surface layer provided by POLYMER (e.g. in ESA's CCI Ocean Colour). HYGEOS is constantly improving SMART-G, now considered like a reference. HYGEOS performs R&D on solar resource applications for photovoltaic and concentrating solar power plants.

POINT OF CONTACT

ADDRESS: 165, avenue de Bretagne
59000 Lille, France

WEBSITE: www.hygeos.com

PHONE +33 (0)3 20 08 24 98

POINT-OF-CONTACT:

TURNOVER

WORK FORCE 12

SPACE TURNOVER

SPACE WORK FORCE 12

Orbital systems
Launchers
Satellites
Ground segments
Transversal competencies

ORBITAL
VIEWS

ORBITAL VIEWS creates high-fidelity simulations of space missions, operations and vehicles, through digital interactive technologies such as 3D, 360, Augmented Reality, Virtual Reality, and physical simulation.

COMPETENCIES & CAPABILITIES

ORBITAL VIEWS has extensive experience in the **3D simulation of space missions** and the **visualization of 3D space data**.

Our team uses high-end 3D rendering software integrated to physical simulators to produce accurate space content and software applications.

Our expertise covers the R&D, design and production of **immersive and interactive applications for the space industry**, including the development of hardware and software operating in weightlessness.



"Simulation of a suborbital flight © Orbital Views"

ORBITAL VIEWS

PRODUCTS & SERVICES

ORBITAL VIEWS produces on-demand space content to support vehicle design, mission simulation, training, and data visualization.

Examples include:

- **Simulations** for space missions, from launch to landing
- **3D renderings** of space hardware
- **3D animations** of space vehicles
- **VR experiences** of space operations

Our company also developed “**Fly in Space**”, a range of hardware and software solutions for the use of Virtual Reality in weightlessness.

Our patented physical simulator “**Virtual Moonwalk**” is also used to simulate manned and robotic operations under lunar or Martian gravity.

MAJOR SPACE PROJECTS & REFERENCES

ORBITAL VIEWS works regularly for private **New Space companies** to simulate sub-orbital, orbital, cislunar and lunar operations.

Our team also worked with **CNES** and **ESA** on the selection of European astronauts, on a manned simulated Mars landing mission (Mars500), and on the improvement of ISS astronaut performance using Virtual Reality. With CNES subsidiary **Novespace**, ORBITAL VIEWS also developed a Virtual Reality platform adapted to weightlessness on 7 parabolic flights.

Previously, our team worked extensively with the **Ministry of Defense** (DGA, SSA), long-haul French **nuclear submarines** (IRBA, FOST), and institutions involved in **Antarctic science** (IPEV, ESA, NASA).

POINT OF CONTACT

ADDRESS 37 rue Louise Weiss
75013 Paris France

WEBSITE www.orbitalviews.com

PHONE +33 (0)6 61 98 14 46

POINT-OF-CONTACT SOLIGNAC, Amaury, CEO
as@orbitalviews.com, +33(0)6 61 98 14 46

TURNOVER undisclosed

WORK FORCE 5

SPACE TURNOVER undisclosed

SPACE WORK FORCE 5

Transversal competencies



Independent
Living Base

Independent Living Base is an AgriTech created in October 2019. It has created a unique system in the world for the organic production of plant foodstuffs in soil above ground in a structure, the Bubble Tech ILB, which can be self-sufficient in water and energy, mobile, modular. This solution can easily be implemented for manned flights and space stations on Mars or the Moon.

COMPETENCIES & CAPABILITIES

Independent Living Base has a multidisciplinary team in botany, electro-technical, climatology, genetics, making it possible to design and manufacture complete on-board systems intended for space to produce continuously and in situ the food essential to astronauts in manned flights or on space bases.

A full-scale demonstrator has been in operation under normal conditions for 2 years. It has produced more than 100 different species of fruits and vegetables continuously.

A mini block of Bubble Tech 8m long, 3m high and 2m wide can produce enough to continuously feed up to 10 astronauts.



INDEPENDENT LIVING BASE

PRODUCTS & SERVICES

Independent Living Base designs, manufactures in France and distributes complete Bubble Tech systems. These food production systems in soil above ground and organic allow people in isolated sites to have abundant, balanced food, rich in trace elements and vitamins, produced continuously. Bubble Tech can be sold or rented to user companies. ILB trains future users (astronauts) of Bubble Tech for 1 to 2 days to help them quickly acquire all the skills to operate and, if necessary, repair the system in the event of a failure. The system has as standard 3 alternative operating solutions in the event of failure allowing it to operate for up to 25 years whatever the conditions.

The obvious interest for space bases is to reduce supplies by cargo, which are very expensive and uncertain, to improve the autonomy of astronauts on Mars or the Moon, to allow them to have on site a varied, fresh and non-iodified food.

MAJOR SPACE PROJECTS & REFERENCES

After more than 2 and a half years of research and tests, concluded by the filing of an international patent in November 2021, Independent Living Base has just started to market Bubble Tech to a diversified large account clientele. Energy companies are interested in feeding their employees in isolated sites in the middle of the desert. Cosmetic pharmacology companies ask ILB to produce flowers to extract essential compounds. Governments, landowners and local authorities are currently asking for quotes to increase local food sovereignty. ILB participated in the CNES Innovation Day on May 17 because Bubble Tech provides a certain and essential, tailor-made solution for the continuous production of food on another planet in order to feed the astronauts who will stay there for periods of several consecutive months.

POINT OF CONTACT

ADDRESS 24 rue Garnier Pagès 94100 Saint Maur des Fossés France

WEBSITE www.independentlivingbase.com

PHONE +33 (0)6 61 90 81 02

POINT-OF-CONTACT : BENVENISTE Pascal, CEO,
pascal.benveniste@independentlivingbase.com, +33 (0)6 61 90 81 02

TURNOVER 0,2 M€

WORK FORCE 15

SPACE TURNOVER

SPACE WORK FORCE 1

Orbital systems
Satellites
Transversal competencies



PRESENTATION OF THE COMPANY

Infinite Orbits (IO) is a New Space Deep Tech start-up founded by graduates from ISAE-Supaero, INSEAD, Stanford and Columbia universities, whose business is to develop and commercialize products and services for the in-orbit Space market. The R&D work carried out within the company, with the help of the Space Rendez-vous Laboratory at Stanford, is mainly based on artificial intelligence (machine learning, computer vision) and GNC (guidance, navigation, and control).

COMPETENCIES & CAPABILITIES

Infinite Orbits is positioned in an orbiting services market under construction to develop in-orbit services using proprietary autonomous navigation & docking technology.

It operates in the following topics: Debris detection and collision avoidance, Space situational awareness (SSA) & traffic management, Rendezvous & proximity operations, GEO satellite inspection, Spectrum preservation of orbital slots.

Infinite Orbits is differentiated through two main technology streams:

- Designing affordable and reliable highly mobile small sat (ChopeSat)
- Developing vision based autonomous navigation using AI (Orbit Guard)
- Combining both technologies to develop a disruptive life extension offer (Endurance)

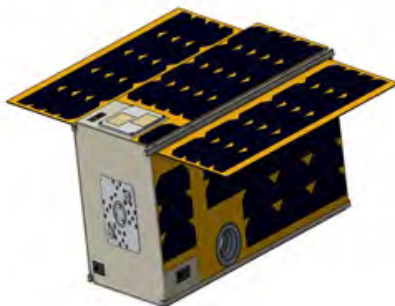

"ChopeSat"

ibe sat

INFINITE ORBITS

PRODUCTS & SERVICES

Infinite Orbits is delivering affordable in-orbit products and services for autonomous space navigation and rendez-vous, that are the following:

- **“ChopeSat”**: A first of its kind geo grade cube sat to perform Bringing Into Use services (Orbital Spectrum protection). The first version will fly on March 2022 via SpaceX Falco heavy launcher.
- **“Orbit Guard”**: A Space Situational Awareness payload carrying specialized cameras and flight computer to perform in-orbit object detection and autonomous navigation. A first In-Orbit Demonstration is being lab tested and scheduled for first in-orbit mission in 2022. First commercial prototype to be delivered late 2022.
- **“Endurance”**: A life extension servicer satellite to perform Rendezvous and docking operations for geostationary telecom satellites. A baseline study has been performed for identified cases from big space telecom players and firm order for preliminary design project is expected before end of 2021.

MAJOR SPACE PROJECTS & REFERENCES

IO has signed its first customers in 2019 and is in track to perform its first in-orbit commercial operation and technology in orbit demonstration.

IO main developments and projects include:

- Successfully launch and operate its first commercial Cube satellite (Planned with SpaceX, Feb 2022)
- Validate Autonomous GNC software platform and adapt it to commercial in-orbit applications (e.g., Debris detection and avoidance, chasing targets, etc.)
- Adapt product offering to fit space military services (surveillance of GEO assets).
- Finalize first baseline review of Life Extension project for a major geo satellite operator, before end of 2021.

POINT OF CONTACT

ADDRESS 13, rue Sainte-Ursule, Toulouse, 31000, France

WEBSITE www.infiniteorbits.io

POINT-OF-CONTACT : HADDOUD Adel, CEO, adel@infiniteorbits.io

+33 (0) 760 763 168

TURNOVER ~5 M€

WORK FORCE 10-15 employees

Transversal competencies



INMIND-VR

Originally developed to evaluate astronaut' orientation abilities, InMind-VR now brings Neuroscience expertise powered by its revolutionary software solution using virtual reality for research labs, medical monitoring and complex environments. Our solutions complement current psychological testing. We assess your teams' neuropsychological features (stress, memory, mental workload, pre burn-out evaluation), we develop specific protocols and create standards for your staff, population or cohort.

COMPETENCIES & CAPABILITIES

InMind-VR is a technological integrator, with its sets of solutions synchronizing all technologies for human behaviors investigation based on physiological, brain and behavior measurements. Develop and run your own VR protocols, combined with 2D/3D and questionnaires in one click, and pre-analyses toolboxes.

InMind-VR is a scientific integrator, gathering and opening the neuroscientific knowledge to its partners and clients. It is a scientific hub, developing and managing consortium of the most renowned neuroscience specialists, to fit the very specific needs of its partners.,

Our partners and clients range from the automotive and aeronautic industry (Airbus, European Space Agency), research and health (clinical trials ongoing), the marketing and industry (office work stress evaluation), up to humanitarian refugees help (development of pre-diagnosis tools during crisis).

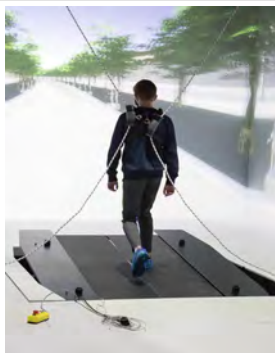

InMind-VR

PRODUCTS & SERVICES

InMind-VR proposes ready-to-use sets of cognitive (mental load, cognitive fatigue...), affective (stress, anxiety, burn-out...) and sensory assessments. These sets are ideal to monitor your team members' health.

InMind-VR can also develop tailor-made protocols, designed for your very own field of work, and for difficult and very specific environments you can meet.

InMind-VR is able to monitor physiological, brain and behaviors during your most difficult task (such as piloting), to assess cognitive function and performance loss. This are key elements to develop biomarkers and algorithms dedicated to online monitoring of cognitive/affective functions, such as stress or fatigue detection.

InMind-VR offers a software solution dedicated to human factor analyses, physiological and brain recording. Easy to master for specialists and researchers, no-code to develop 3D/VR/cave protocols, fast development, proprietary data, no cloud.

MAJOR SPACE PROJECTS & REFERENCES

InMind-VR is currently powered by ESA-Bic Nord and Nubo / TechTheMoon CNES incubators. Its solutions have been validated to measure the performance of spatial orientation and attentional capacities in microgravity during parabolic flights. This complete solution will allow to optimize the selection, the preparation and monitoring of the performances of the future astronauts and Moon workers for their safety and the success of their missions.

In addition, research and clinical evaluation of the human factor in spatial environments need unification and simplification of methodological tools. Our tool is an integrated software platform to standardize and share research, evaluation and human monitoring protocols. The goal is to be able to use these tools for research on Earth or in space station, as well as for the evaluation of cognitive and behavioral functions in lunar base.

POINT OF CONTACT

ADDRESS 17 rue Claude Bloch, 14000 Caen, France

WEBSITE www.inmindvr.net

PHONE +33 (0)6 77 18 40 61

POINT-OF-CONTACT : Montardy Quentin, CEO InMind-VR

quentin.montardy@inmindvr.net - +33 (0)6 77 18 40 61

TURNOVER

WORK FORCE 5 employees

SPACE TURNOVER

SPACE WORK FORCE 5 employees

Orbital systems
 Launchers
 Satellites
 Transversal competencies



InterAC offers high-tech engineering services in numerical vibro-acoustic and in methodology in various domains as aerospace, automotive, building, defence, energy, mechanical, railway.

COMPETENCIES & CAPABILITIES

- Predicting studies and numerical optimization of dynamic systems.
- Software development dedicated to experimental and analytical SEA (Statistical Energy Analysis). Introducing Virtual SEA (VSEA) technology in the design phase leads to cost reduction in prototyping and testing, VSEA enhances SEA modelling of complex structures by using Finite Element (FE) model to perform vibrational tests, improving models reliability.
- Participation to research projects.
- Training for engineers: calculation and measurements on SEA method.

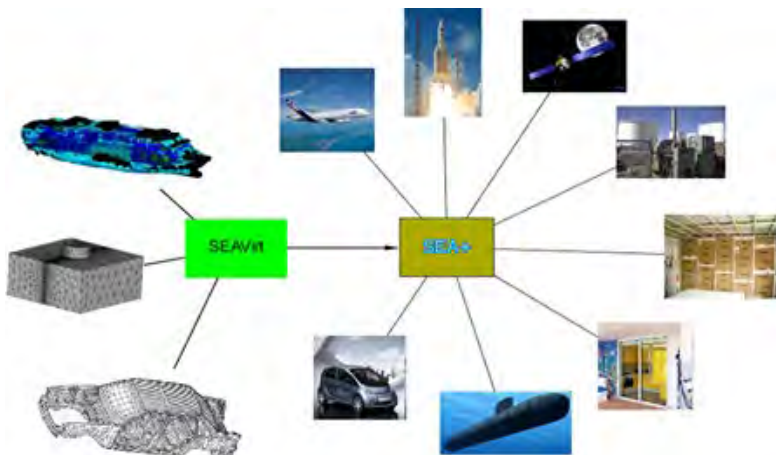

InterAC

PRODUCTS & SERVICES

SEA+ (basic module):

- Object-oriented Software for engineers to predict Noise and Vibration (N&V) design process

Four optional modules:

- SEAVirt: allows engineers to more effectively interpret Finite Element (FE) prediction for the N&V design process
- SEA-Shock: is designed to successfully predict Shock Response Spectra (SRS) from transient loads applied to SEA models of dynamical systems. For aerospace applications, SEA-Shock includes source models for pyrozip and clampband separation events.
- SEA-Foam: multiplies the capability of SEA+ by creation of acoustic trims connected to structural and/or acoustic subsystems for predicting interior or radiated noise
- SEA-Cyl: integrates a spectral method for the vibroacoustic modeling of multilayered cylindrical systems

MAJOR SPACE PROJECTS & REFERENCES

- SEA model of payloads for random acoustic responses, for pyroshock responses (CNES).
- FE and SEA models of Ariane 4 & 5 for pyroshock response prediction
- Shock synthesis using SEA (CNES).
- Identification of vibrational sources and quantification of associated injected powers from acceleration measurements (CNES).
- SEAMIC: Use of Statistical Energy Analysis for MICRo-Vibration Analysis (ESTEC/CNES).
- METAMIC: METHodology for analysis of structure borne MICRo-vibration (ESTEC/CNES).
- Development of an acoustic device for lift-off qualification of the cryogenic engine of Ariane 5 and Acoustical improvement of the ground test facilities for Vulcain acoustic qualification at lift-off (SNECMA).

POINT OF CONTACT

ADDRESS 10 impasse Borde Basse
31240 L'Union France

WEBSITE www.interac.fr

PHONE +33 (0)5 61 09 47 45

POINT-OF-CONTACT : Borello, Gérard, Manager, gerard.borello@interac.fr
+33 (0)5 61 09 47 45

TURNOVER 0.5 M€

WORK FORCE 4 employees

SPACE TURNOVER 0.1 M€

SPACE WORK FORCE 2 employees

Transversal competencies



Intraspec is specialised in defect analyses, defect localisation, reliability and qualification of electronics, optoelectronics, optical components and assemblies as well as in the entry control and electromagnetic compatibility.

COMPETENCIES & CAPABILITIES

Electrical and electro-optical characterizations of electronics, optoelectronics and optical components.

Reliability of electronics, optoelectronics and assemblies for space application (eg optocouplers, LEDs, Lasers, High-voltage MCP).

Defect localisation using non destructive techniques (Magnetic microscopy, Lock-in Thermography) and technological inspections (Micro electronics, FIB).

Destructive Physical Analyses.

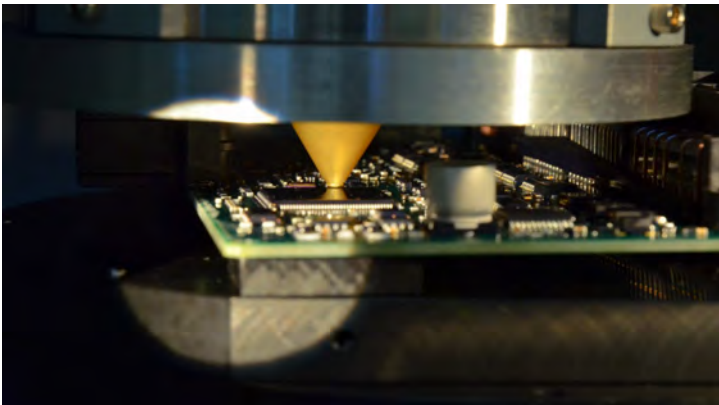

SQUID Sensor analysing the current track on assembled PCB (Magnetic microscopy)

INTRASPEC TECHNOLOGIES

PRODUCTS & SERVICES

Failure analysis: we have an advanced and transversal expertise to design, follow and present a complete failure analysis. From failure characterization, non-destructive localization up to destructive physical analysis we help you determine the root cause of your defect.

Entry control: we provide bespoke services to control your components, PCBs and assemblies amongst which functional tests, product performances validation, construction analysis, visual inspection, burn-in, counterfeit detection,...

Reliability: we support you in assessing your product in terms of performance, cost, quality and reliability using optimized test plan definition, custom test bench development, accelerated life tests execution, ageing data analysis and early failure prevision.

Qualification: we perform qualification tests for your components including radiation tests and radiation effects simulated with pulsed laser.

MAJOR SPACE PROJECTS & REFERENCES

Here are a couple of our main space projects:

- Stack laser of the Supercam of the Rover
- LEDs of the camera for the MMX Rover
- High voltage optocouplers for Juice and Solar orbiter missions
- Analyses of the calibration lamps of Microcarb
- Magnetic measures of the micro valve of a chromatograph system for Dragonfly
- Taranis (photomultipliers)
- Defect analyses on the cables of CSO and CERES.

POINT OF CONTACT

ADDRESS 20 avenue Didier Daurat
31 400 Toulouse France

WEBSITE www.intraspec.com

PHONE +33 (0)9 72 42 24 74

POINT-OF-CONTACT : Craplet, Anne-Claire, Sales Engineer

anneclaire.craplet@intraspec.com, +33 (0)6 51 49 01 79

WORK FORCE 11 employees

Satellite electric propulsion
Transversal competencies



Launched in 2021, ION-X provides electric propulsion solutions for small satellites. Based on patented electro spray technology, our unique ionic liquid thruster is the next big thing in small satellites propulsion. It will deliver unmatched thrust and fuel efficiency while offering great operability with non-toxic & non-pressurized propellant. ION-X first demo mission is expected for mid-2024 onboard SpaceX Falcon9 Transporter mission.

COMPETENCIES & CAPABILITIES

ION-X currently designs, develops and commercializes a new type of electro spray propulsion system for small satellites.

Our thruster uses a mesh of thousands of nano-spikes, and an intense electric field to dissociate ions from the ionic liquid - our green, inert and non-toxic propellant. As a result of this dissociation, ions are ejected at very high speed, therefore generating extremely efficient propulsion.

The company has acquired significant design and testing capabilities in electric propulsion, high-voltage electronics, on-board computer, fluidic system, plume characterization and more generally vacuum equipment.



ION-X

PRODUCTS & SERVICES

ION-X thruster currently under development, has the following specification:

- Propulsion performances:
 - o 1mN of thrust
 - o 5000s of ISP
- Form Factor 1U
- < 1.5 Kg wet mass
- < 50W electric power draw
- CAN communication protocol
- Non-pressurized, inert and green propellant
- No external cathode
- No warm-up period
- Stealth / low signature exhaust beam

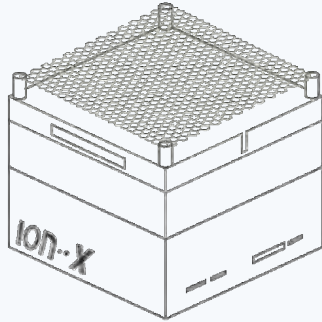

MAJOR SPACE PROJECTS & REFERENCES

- Demonstration mission #1 planned with Endurosat 12U platform on-board Space-X Falcon9 for Q3 2024
- Demonstration mission #2 planned with Space Inventor and Infinite Orbits on EDISON mission, in the frame of ESA's Pioneer program. Launched currently planned for the 2nd half of 2024
- Demonstration mission #3 planned with a French small satellite manufacturer for Q1 2025

POINT OF CONTACT

ADDRESS 10 Boulevard Thomas Gobert, 91120 Palaiseau

WEBSITE <https://ion-x.space>

PHONE +33 (0)6 31 89 46 52

POINT-OF-CONTACT : Hiriart Thomas, CEO
Thomas.hiriart@ion-x.eu, +33631894652

TURNOVER N/A

WORK FORCE ~15 employees

SPACE TURNOVER N/A

SPACE WORK FORCE ~15 employees

Transversal competencies



ISP SYSTEM is specialized in high-precision mechatronics. We design and manufacture micro- and nanopositioning systems, high resolution embedded actuators, opto-mechanics, complete mechanisms and special assembly machines for many markets (aerospace, defense, photonics, science, medical, railways, electronics...).

Our staff is composed of 30% engineers and we deliver turn-key solutions to our customers.

COMPETENCIES & CAPABILITIES

Competencies in mechanics, optics, vacuum, electronics, automatism.
Design of mechanical and electro-mechanical parts (Pro-Engineer, CATIA, SOLIDWORKS).
FEM calculations (static loads, dynamic loads, vibrations, shocks, thermal behavior, opto-mechanics): NASTRAN
Consideration of ECSS standard in our processes.
Validation and tests (internal or with partners).
ISO5, ISO6 and ISO7 clean rooms, large vacuum chambers for bake-out and outgassing tests.
High precision metrology equipment.
Optical test bench for validation of opto-mechanical systems (aperture up to Ø500mm).

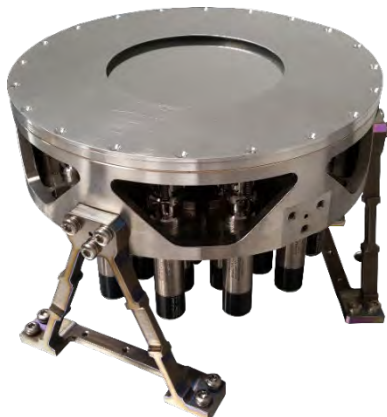

Space compatible electro-mechanical deformable mirror

ISP SYSTEM

PRODUCTS & SERVICES

Products:

- Embedded linear and rotary actuators using DC motors, stepper motors, linear motors and voice-coil
- Opto-mechanics (deformable mirror, force actuators, tip-tilt mounts...)
- Controllers for ground applications and GSE
- Complete mechanisms for GSE (opto-mechanics, mechanisms including controller)
- Low-outgassing materials and lubricants

Services:

- Design, manufacturing and Maintenance of our products.
- Manufacturing of EM, EQM, FM (quantities up to several 100's of parts/year)
- Design and manufacturing of ground control electronics (hardware and software)
- Installation of systems / machines at customer site

MAJOR SPACE PROJECTS & REFERENCES

High resolution actuator (resolution: 50nm, stroke 50mm) for SEIS project (back-up solution), qualified with CNES

Space deformable mirror for OTOS-ACMAS project (TRL 6)

Force actuator for space deformable mirror for TAS (TANGO project, TRL6)

Linear and rotary actuators for balloons (fine pointing)

GSE:

Goniometer for thermos-vacuum tests (-150°C, 10⁻⁶ mbar) of SEIS payload (30kg)

Large motorized Gimbal mount, vacuum compatible (Mirror Ø1,5m) for REOSC and ADS (EUCLID project)

Large gantry (6m x 4m) for assembly of space solar panels

Silver Oxalate sintering machine for space electronics assembly

POINT OF CONTACT

ADDRESS Zone Industrielle de la Herray – BP 10047
65 501 VIC-EN-BIGORRE CEDEX France

WEBSITE www.isp-system.fr

PHONE +33 (0)5 62 33 44 44

POINT-OF-CONTACT : ROPERT, Laurent, Account Manager
laurent.ropert@fr-ispgroup.com +33 (0)6 81 54 25 99

TURNOVER 10,3 M€

WORK FORCE 80

SPACE TURNOVER 1,5 M€

SPACE WORK FORCE 10

Satellites
Transversal competencies



I am a senior optical payload expert with 35 years of experience. I am passionate by new space. I created my company in June 2021. I help the small companies (SMEs, TPE) grow in the new space and I support the government institutions in the new space sector.

COMPETENCIES & CAPABILITIES

Competence: Concept, feasibility, and engineering studies of space systems; Assistance in -up objects and contracts; Assistance to projects and contracts follow-up; Optical expert; Orbital systems prime contractor; Security-defense payload; AIV AIT; System engineering.

Capabilities: innovating and pioneer spirit, support to develop cost-effective and efficient solution, support for procurement, building offer, management RFI/RFQ.



JFB Space Consulting

PRODUCTS & SERVICES

My services concern the Bid, the development plan, all technical aspects, the business aspects, the organization, the recruitment. The scope can be the optical payloads but also the overall system: satellite, ground segment, image processing and services.

MAJOR SPACE PROJECTS & REFERENCES

Hyperspectral payload for nanosat developed with a French PME.

End to end hyperspectral system and services developed with a French consortium (PMEs & research institute).

SSA payload for nanosat developed with a French PME.

ISAAC (CNES development) demonstrator of an innovative onboard image detection chain based a new high-performance SOC, developed with a French consortium TPE and PME.

Optical payload expertise for a French operator start-up in the new space.

POINT OF CONTACT

ADDRESS 247 Boulevard Emile Carbon
06 210 Mandelieu, France

WEBSITE

PHONE +33 (0)6 31 18 16 31

POINT-OF-CONTACT : Blanc, Jean-François, CEO JFB Space Consulting
jfb.space.consulting@gmail.com, +33 (0)6 31 18 16 31

TURNOVER NA - Launched in 2021

WORK FORCE 1

SPACE TURNOVER

SPACE WORK FORCE 1

Launchers
Satellites
Transversal competencies



Industrial group specialised in metal or composites parts and sub-assemblies manufacturing for Aeronautics, Space and Defense.

The symbiosis between our three business units enables us to present our clients with a global solution.

COMPETENCIES & CAPABILITIES

Study(co-design) and manufacturing of primary and sub assembly mechanical parts.

Complex machining.

Precision bodywork and sheet metal.

Tooling: Manufacturing of special.

Surface treatment and painting.

Assembly.

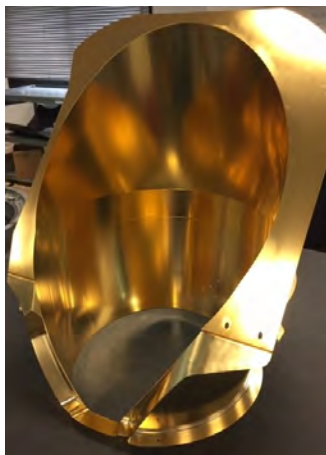

JVgroup

PRODUCTS & SERVICES

Bespoke designs, manufacture and production; JVgroup offers a global solution to all kinds of specific orders in the Aerospace and Defence sectors, thanks to the complementarity and synergy between our business units.

Within each business unit, JVgroup has built up significant technical means which are exploited by teams of experts who build and manufacture products to meet the specifications of the purchaser.

MAJOR SPACE PROJECTS & REFERENCES

Ariane Group (A6)

Airbus Defence and Space (OneWeb, NAOMI, NAOMIX, CERES, NEO...)

APCO Technologies

AIR LIQUIDE

DOMAERO

POINT OF CONTACT

ADDRESS 9 rue Bernard Palissy
33700 Mérignac France

WEBSITE www.jvgroup.fr

PHONE +33 (0)6 33 22 54 56

POINT-OF-CONTACT : Jean-Francois AUGER, JVM sales director,
jean-francois.auger@jvmechanics.com, +336 33 22 54 56

TURNOVER 32 M€

WORK FORCE 350 employees

SPACE TURNOVER 5 M€

SPACE WORK FORCE 50 employees

Transversal competencies



Kayros is the leading global asset observation platform built on fundamental science, strong R&D, and leading technology. Harnessing satellite imagery and multiple sources of unconventional data with machine learning, natural language processing, and advanced mathematics, Kayros monitors and measures energy and natural resource activity worldwide.

COMPETENCIES & CAPABILITIES

- SAR image processing (focusing, co-registration, coherence analysis, interferometry),
- MultiView stereo 3D mapping with VHR optical imagery (RPC refinement, stereo matching, triangulation, DSM/DTM estimation),
- Multi-frame Super-Resolution,
- Analysis Ready Data generation from Landsat and Sentinel L1 products (clouds detection, atmospheric corrections, co-registration, radiometric equalization),
- Hyper-spectral image analysis, Large-scale object detection

KAYRROS-CONFIDENTIAL

Kayros Studio Platform makes actionable analysis faster

- All data sources**
from satellite images to geolocation data accessible on demand into a centralized place
- At the asset level**
with options to define sub-assets and easy imports
- < 1-week of setup**
from Customer need definition to Product configuration
- Anywhere**
in the world
- In near-realtime**
up to a daily frequency with access to historical and archive data

The Kayros two-step process makes actionable analysis faster

1 Define

2 Analyze

KAYRROS

PRODUCTS & SERVICES

With access to data on more than 200,000 industry assets, Kayrros customers track individual or multiple assets in configurable proprietary or collaborative workflows to analyze industrial and environmental performance for maximum insight and optimal operational and financial decisions.

Service lines:

- Emissions monitoring
- Flood Tracker
- Infrastructures monitoring
- On Road Demand
- Jet Fuel Consumption
- Crude Oil Inventories
- E&P Intelligence
- LNG Intelligence
- Refinery Intelligence
- Metals & Minerals

MAJOR SPACE PROJECTS & REFERENCES

- METHAN WATCH (ESA)
- C-TREES (EUROSTARS)
- FLOOD TRACKER (ADEME)
- GREEN (EIC)
- PAWES (EIC)

POINT OF CONTACT

ADDRESS 33 RUE LAFAYETTE
75009 PARIS France

WEBSITE www.kayrros.com

PHONE +33 (0)1 87 39 00 51

POINT-OF-CONTACT : Camus, Julien, Administrative Director
j.camus@kayrros.com, +33 6 2109 7477

TURNOVER 4,1 M€

WORK FORCE 140 employees

SPACE TURNOVER 4,1 M€

SPACE WORK FORCE 140 employees



Transversal competencies

KERDRY developed a specific industrial tool to offer **optical and metallic coatings**. KERDRY: a park of PVD (Physical Vapor Deposition) machines installed in **1000 m² of clean rooms**. **Photolithography** steps can be associated with these coatings to produce localized deposits. These skills enable us to address markets as diverse as Space, Medical, Defense, Aeronautics, Telecommunications, Luxury Goods or Research

COMPETENCIES & CAPABILITIES

- Dielectric Coating (AR, filters, Bragg mirror, Custom)
- Metallic protected and enhanced Mirror Coating (Al, Ag, Au)
- Absorber (Black coating)
- Transparent and conductive coating (ITO)
- Metallization for soldering
- Sputtering, E-beam (IAD), Thermal evaporation, Photolithography

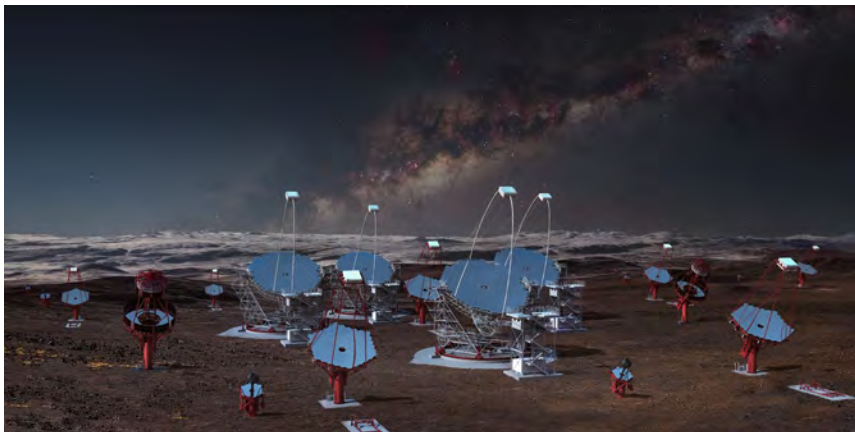

KERDRY

PRODUCTS & SERVICES

METALLIC COATING (Au, Ti, Pt, Ag, Al, Cu, Cr, Ni, Nb...)

- Evaporation and Sputtering
- Mirror, Soldering, Conductivity, Air tightness of packaging...

OPTICAL COATING

- Electron beam with ion assisted deposition
- Antireflective, Mirror, Dichroic, Cold mirror...
- Optical bandwidth: 0,35 µm to 15 µm
- Capacity up-to 1.40 m (55") substrate diameter

PHOTOLITHOGRAPHY

- On substrate from 2" up to 8"
- Process lift off, Wet & Dry Etching
- Resolution: few micrometers

OPTICAL FIBER COATING

- Optical filter - Mirror
- Metallic Coating for soldering

MAJOR SPACE PROJECTS & REFERENCES

- Metallization for JUICE project (SAP Micromecanique) : gold coating on hyperfrequency mixer
- Metallization for SEIS project (Sodern) : gold coating on domes

POINT OF CONTACT

ADDRESS 5 rue Louis de Broglie, 22300 LANNION – FRANCE

WEBSITE <https://kerdry.com>

PHONE +33 (0) 2 96 48 84 77

POINT-OF-CONTACT : Pouessel Alban, Sale-Engineer, +33 (0) 7 87 26 45 54
commercial.kerdry@hef.group

TURNOVER 2 M€

WORK FORCE 20

SPACE TURNOVER 0,1 M€

SPACE WORK FORCE 2,5

Orbital systems
Satellites
Ground segments
Space planes
Transversal competencies



Founded in 2019, Kinéis is a satellite operator and a global connectivity provider. It inherited CNES and CLS expertise from more than 30 years of working with the Argos system and developed reliable technology that provides easy access to useful satellite data. In order to make life easier for professionals and individuals and to encourage them to use its product and services, Kinéis locates and connects objects wherever they are on the planet. It does this by deploying its full capacity for technological innovation to combine NewSpace and IoT.

COMPETENCIES & CAPABILITIES

Kinéis is the first fully financed constellation of nanosatellites dedicated to the IoT in Europe. The satellites are being designed and manufactured in France.

Our expert team designs the whole system, develops the ground segment, the IT infrastructure and all the chipsets needed to build the devices.



Kinéis

PRODUCTS & SERVICES

Kinéis is a tool for **scientists and climatologists**, helping them to collect data from oceans, wildlife and the atmosphere. And knowing better our environment leads to protect it more: as an example, when you know the tracks of migratory birds, you can take protective measures along their flight paths.

Kinéis is also suitable for **livestock and smart agriculture**, by letting know to the farmer where its cattle is and if it behaves normally, or adjusting the amount of water distributed in a field according to soil moisture data.

Kinéis' connectivity also proved its value in monitoring **boats and fisheries**, as it allows to better manage natural resources and improve the security of fishermen with weather alerts or rescue messages.

In the **logistics area**, knowing the position of the cargo or container improves the quality of delivery service and helps adjusting the stock.

Kinéis Adventure will create a community of adventurers going to remote areas, allowing them to keep in touch with friends and family, and send SOS messages in emergency situations.

Besides connectivity, Kinéis provides **hardware and software** to connect the devices.

MAJOR SPACE PROJECTS & REFERENCES

Kinéis inherits from more than 30 years of experience of the Argos system. Argos has been up and running since the late 80s and still supports the scientific community to better understand and protect the planet.

POINT OF CONTACT

ADDRESS 11, rue Hermès, Parc Technologique du Canal
31 520 Ramonville Saint-Agne France

WEBSITE www.kineis.com

PHONE +33 (0)5 61 39 47 00

POINT-OF-CONTACT: Alexandre TISSERANT, CEO, info@kineis.com

TURNOVER 5,0 M€

WORK FORCE 40

SPACE TURNOVER 5,0 M€

SPACE WORK FORCE 40

Ground segments
Transversal competencies



Kratos Communications provides Ground Solutions, using COTS products, for Satellite operators, Armed forces, Frequency Regulators, Intel Agencies and Services providers.

Our solutions includes antennas, satellite control, network management, spectrum management, Interference detection and geo-location, RF Space Situational Awareness. The solutions operate on private data centers or public Cloud.

COMPETENCIES & CAPABILITIES

Our core competencies reside in providing Commercial-Off-The-Shelf products and using them, with strong engineering capabilities, to assemble turnkey systems and to support them over the long-term.

Our strong capabilities are command and control, signal processing, Cloud, software engineering and Software-defined network architectures.

We are used to deploy our products and technologies all over the World.

End-to-End Satellite Operations Solutions

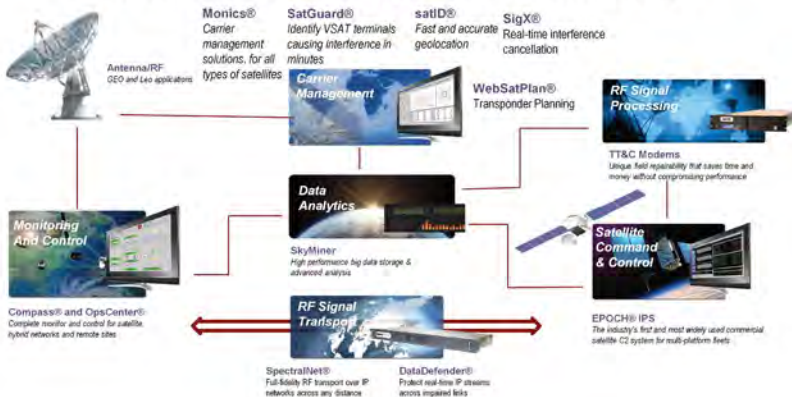

KRATOS COMMUNICATIONS

PRODUCTS & SERVICES

Kratos Communications, in Labege, is part of Kratos Defense and Space. We provide ground segment solutions to operate satellites, all over the World.

Our main products, as illustrated on the picture above, are:

- Antenna/RF: from 3.8m to 18m in all frequency bands
- EPOCH for satellite Command and Control
- COMPAS for Network management
- Monics Family: Spectrum monitoring, geolocation, VSAT monitoring
- Data Analytics
- All these products are working on classic on premises architecture or public Cloud like AWS or Azure.

MAJOR SPACE PROJECTS & REFERENCES

Major Reference projects for Kratos Labege:

- METOP Core MCS for controlling EUMETSAT satellites
- Yahsat and Thuraya ground segments
- Es'Hailsat ground segment in Qatar
- Regulatory system for the sultanate of Oman and Qatar
- Kacific Ka-band gateway and NOC in Singapore
- Multi-function satellite ground and spectrum monitoring in Indonesia

POINT OF CONTACT

ADDRESS: 57 rue Marco Polo
31675 Labege France

WEBSITE www.kratosdefense.com

PHONE +33 (0)5 61 00 22 10

POINT-OF-CONTACT: DUPAS Bruno, President
bruno.dupas@kratosdefense.com, +33 5 61 00 22 10

TURNOVER: 18 M€

WORK FORCE: 43 employees

SPACE TURNOVER 18 M€

SPACE WORK FORCE: 43 employees

Orbital systems
 Launchers
 Satellites
 Ground segments
 Balloons
 Transversal competencies

LATÉCOÈRE
 AEROSTRUCTURES & INTERCONNECTION SYSTEMS

LATecoere interconnection Systems is the brand name of LATElec which is 100% LATECOERE Subsidiary.

It is a specialist in electrical harnesses and electrical racks for aeronautic with a dedicated Business Unit for space activity located near Montpellier. It is involved in telecom, observations & sciences, launchers and exploration programs, constellations, for industrial prime customers (Airbus Defense & Space, Thales Alenia Space, OHB, LeoStella) or agencies (CNES, ESA, NASA).

COMPETENCIES & CAPABILITIES

- **HARNESS DESIGN:** Routing, Connectors Brackets, Tie base location, Layout drawings, From/to definition, connectors & contacts definition, Wires type definition & sizing (Voltage drop, current rating), shielding, over shielding & backshells definition, electrical drawings,
- **PARTS PROCUREMENT:** All components,
- **INDUSTRIALIZATION:** 3D Scale1 mock-up, Manufacturing files, Installation procedures,
- **MANUFACTURING/CONTROL/TESTS**
- **INSTALLATION:** On flight structures at customers Premises-Thermal hardware connection to Flying leads & final functional tests.

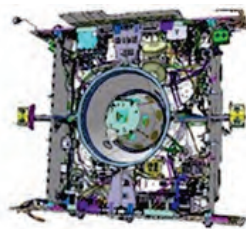

LATECOERE INTERCONNECTION SYSTEMS

PRODUCTS & SERVICES

Service Module (SM) & Communication Module (CM) harnesses for telecommunication programs (9,000 to 46,000 points)

Satellites Harnesses for Sciences & Observation missions (2,000 to 18,000 points)

Instruments harnesses (600 to 11,000 points)

Electromechanical assemblies like Fuse boxes (400 points)

Plugs with components (diodes, fuses, resistors)

Battery harnesses (1,100 points)

Main Processes used are Crimping, Soldering, Potting, Gluing, Lacing, Over shielding of harnesses (braids or aluminium tape)

Procurement of parts with PAD's sheet including sub-assemblies like 1,553 Milbus and RF harnesses

Harness tested in 1 time (15,000 points) with inhouse test bench

Thermal Vacuum Test Chamber (Bake out with/without TQCM, Thermal test)

MAJOR SPACE PROJECTS & REFERENCES

More than 200 harnesses for Telecom programs based on Eurostar & Spacebus platforms (SM &/or CM harnesses)

23 Myriade models (PF &/or CU) 3 Proteus platforms

4 Sentinel 1 models: satellite harnesses

4 Sentinel 2 models: MSI Instrument

4 Sentinel 5 models: UVN & IHAR & METIMAGE & IASING Instruments and participation to ATLID, GAIA, GEOLOC, GK2, GOMOS, MERLIN, MHS, PHARAO, PRISMA programs

5 ATV Models: Equipement Avionic Bay (EAB) Harnesses

3 ORION Models: European Space Module (ESM) Harnesses

2 Constellations: Globalstar 2 (24 models) & Blacksky (24 models)

POINT OF CONTACT

ADDRESS 762 Rue Max Planck - CS 57632
F-31676 - Labège - Cedex France

WEBSITE www.latecoere.aero

PHONE +33 (0)4 67 87 41 73 / +33 (0)6 89 95 48 47

POINT-OF-CONTACT: Michel Vial
Key Account Manager/Space BU Sales Manager
1080 Impasse des Bigos, 34740 VENDARGUES

TURNOVER > €350m

WORK FORCE 2000

SPACE TURNOVER €9m

SPACE WORK FORCE 80

Orbital systems
 Launchers
 Satellites
 Ground segments
 Transversal competencies



LATESYS is a subsidiary of ADF Group. French group, international oriented, proposing to industrial players Smart Industrial Solutions & Services enabling improvement of your performance.

We understand your present
 To design your future
 Design & Build your performance
 Secure your productivity & improve your profitability
 For an optimized Total Cost of ownership

COMPETENCIES & CAPABILITIES

Engineering Services
 Manufacturing Services
 Metrology expertise
 Assembly lines
 MGSE
 Complex Systems
 Test Benches
 Mechanical structures
 Maintenance and exploitation



LATESYS (ADF Group)

PRODUCTS & SERVICES

Launch pad:

- Complex sub-systems of launch pad
- Exploitation, maintenance and transport

Satellite:

- Engineering (design, calculation)
- Design and build

MGSE:

- Lifting devices, multipurpose trolley, Thermal vacuum, RF, 0g for integration and test

Production and tests means:

- Assembly lines
- Automated / robotized assembly means
- Control means (3D, optical, NDT...)

R&T:

- Robotics / AIT – 4.0
- Mechanism

MAJOR SPACE PROJECTS & REFERENCES

Launch-pad:

- **Ariane 5-6** sub-systems : LBS, SAV, Bras Cryo, LLPM & ULPM PCC
- **CSG** : Exploitation, maintenance et transport

Satellite:

- Structure manufacturer of all **Myriade** satellite (27 S/C)
- Structure integration (**Spot6-7, KRS...**)

MGSE:

- More than 500 MGSE for major Telecom, earth observation, launchers, science...

Assembly Lines and automated production means:

- **IRRIDIUM NEXT, ONEWEB, CO3B, ONESAT**
- **Ariane 6** : ULPM, LLPM and HAL

POINT OF CONTACT

ADDRESS 1 av Pierre-Georges LATECOERE
31570 Sainte Foy d'Aigrefeuille France

WEBSITE www.groupeadf.com

PHONE +33 (0)5 62 18 81 31

POINT-OF-CONTACT : DELAS Sébastien sebastien.delas@latesys.com

TURNOVER 80 M€ for LATESYS

WORK FORCE 500 employees for LATESYS / 3 200 employees for ADF

SPACE TURNOVER 20 M€

SPACE WORK FORCE 200 employees

Orbital systems
Launchers



LATITUDE is a start-up in the aerospace sector whose main activity lies in the development of orbital launcher.

COMPETENCIES & CAPABILITIES

LATITUDE is providing the following services:

- Launcher engineering
- Launcher Propulsion
- Launch operator
- Orbital systems engineering
- Aerothermodynamics
- Flight dynamics



LATITUDE

PRODUCTS & SERVICES

LATITUDE develops and operates the smallest launcher dedicated to cubesats and nanosats. With 70kg of orbital capabilities, Zephyr will be able to bring all cubesats and nanosats to the correct orbit and reduce ride-share.

MAJOR SPACE PROJECTS & REFERENCES

Zephyr is a cost-effective launcher with several innovative components. Venture Orbital systems was selected during CNES R&D challenge for its 3D printing engine.

POINT OF CONTACT

ADDRESS 8 allée du Vignoble, 51100 France

WEBSITE <https://www.latitude.eu>

PHONE +33 (0)6 81 76 95 11

POINT-OF-CONTACT : Maximin Stanislas, CEO

stanislas.maximin@latitude.eu

+33 (0)6 81 76 95 11

TURNOVER

WORK FORCE 20

SPACE TURNOVER

SPACE WORK FORCE 20



Transversal competencies

LISI AEROSPACE Additive Manufacturing (LISI AEROSPACE AM) is the LISI Group entity that specializes in metal 3D printing technologies. A recognized player in the aeronautics, defense and space markets, LISI AEROSPACE AM brings the industrial excellence of the LISI Group to additive manufacturing.

COMPETENCIES & CAPABILITIES

LISI AEROSPACE AM owns seven metal fusion machines, including one machine for oversize dimensions (800 x 400 X 500 mm). These machines operate 24 hours a day on site, while their metallurgic characteristics are analyzed for each production batch.

LISI AEROSPACE AM post-processing infrastructure ensures the machining and finishing of parts – including sanding, polishing, and chemical machining operations.

LISI AEROSPACE AM possesses the equipment needed to perform geometric and dimension controls on manufactured parts (3D scanner, 3D measurement machine).



LISI AEROSPACE AM

PRODUCTS & SERVICES

Additive manufacturing provides a wide range of benefits, from producing lighter pieces to designing components that were impossible to manufacture until now. Backed by the expertise and long-term vision of LISI AEROSPACE, the company is a leader in the serial production of flight parts, using the latest metal powder bed technology, integrating all the resources necessary for producing finished parts.

LISI AEROSPACE AM possesses vast experience in deformation and production simulations for a wide variety of parts. This experience and expertise enable LISI AEROSPACE AM to work with its customers to optimize the design of manufactured parts (topology optimization, modifying design to reduce support volume and enhancing the strength of the fusion process).

MAJOR SPACE PROJECTS & REFERENCES

Our serial pieces we produce are already in service, notably on the THALES ALENIA SPACE satellites, AIRBUS A350 Aircraft and DASSAULT AVIATION Falcon and Rafale.

THALES ALENIA SPACE is to use our parts in the series production of its satellites. Parts for the satellite currently include four custom-designed reaction wheel brackets. Manufactured in a single part, these brackets incorporate connector and cable fittings, cutting out the need for assembly. By switching to 3D printing for the production of these parts, Thales has managed to deliver a 10% cost saving, shorter lead times, and an overall weight reduction of 30%, all while increasing performance.

POINT OF CONTACT

ADDRESS 2 route Robert Algayon
33640 AYGUEMORTE-LES-GRAVES

WEBSITE <https://www.lisi-aerospace-am.com/en/>

PHONE +33 (0)1 40 19 84 63

POINT-OF-CONTACT : EYRIGNOUX Sébastien, Space Project Manager,
sebastien.eyrignoux@lisi-aerospace-am.com, +33 (0)6 85 75 87 85

TURNOVER 2 M€

WORK FORCE 25

SPACE TURNOVER 1 M€

SPACE WORK FORCE 12

Orbital systems
Satellites
Ground segments
Transversal competencies



Loft Orbital deploys and operates space infrastructure as a service, providing rapid, reliable, and simplified access to orbit for customer payloads. The company has developed the Payload Hub, a hardware and software interface which enables Loft Orbital to fly dedicated missions or multiple customer payloads simultaneously on a standard satellite bus design. Loft Orbital has three missions planned for 2021, and quarterly missions in 2022.

COMPETENCIES & CAPABILITIES

Our business model emphasizes standardization over customization to remove the need for non-recurring engineering (NRE). This strategy consists of three elements:

1. Develop the hardware and software abstraction layers to decouple payloads from the bus and operations.
2. Use an identical, fixed satellite bus design for each mission.
3. Bulk buy satellite bus hardware from a third-party and hold in inventory for quick deployments of customer payloads.

This approach reduces schedule uncertainty as well as overall mission risk without introducing new constraints and saving years on the schedule. Though the spacecraft may carry different payloads, it retains its heritage by remaining untouched between missions.



LOFT ORBITAL

PRODUCTS & SERVICES

Loft Orbital is a provider of space infrastructure as-a-service. Its technologies act as universal adapters to accommodate missions in drastically reduced schedules.

The Payload Hub is a modular, bus agnostic and payload agnostic interface adapter that allows a plug-and-play approach to satellite missions. It offers flexibility in satellite design, decoupling the customer's responsibility and requirements (the payload) from the satellite. This minimizes schedule and costs.

Cockpit is a first-of-its-kind mission control system. Almost all satellites use a specifically design software stack to command and control it. This has led to most organizations working with mission control software that cannot incorporate different mission requirements, ground stations, or data types, or be scaled easily without re-architecting.

Together, these core technologies enable Loft Orbital to deliver unprecedented speed-to-orbit without compromising reliability or schedule for even the most demanding customer payloads.

MAJOR SPACE PROJECTS & REFERENCES

- Partnership with Scientific Systems Company Inc. (SSCI) to fly a demonstration of the Defense Advanced Research Projects Agency (DARPA) Pit Boss mission system on one of its satellite YAM-3.
- Eutelsat onboard the first Loft Orbital missions to fly telecommunication payloads on YAM-2 and YAM-3.
- Hyperspectral mission for the UAE Government on YAM-2.
- Partnership with LeoStella to provide YAM-3 and YAM-5 buses.
- Large range of partners: ground segment providers, payloads manufacturers, launchers, etc.

POINT OF CONTACT

ADDRESS 3 rue Alaric II
31000 Toulouse France

WEBSITE www.loftorbital.com

POINT-OF-CONTACT : Pierre BERTRAND, Head of Innovation Center
pierre.bertrand@loftorbital.com
+33(0)6 08 01 56 12

WORK FORCE 60 employees (20 in France)

Ground segments
Satellites
Transversal competencies



M3 Systems is a French SME of 50 employees created in 1999 specialized in high performance positioning applications based on GNSS.

Located near Toulouse (Lavernose-Lacasse), the company is also present in Brussels (Belgium) and in Castanet-Tolosan (31) with its subsidiary (BOREAL SAS) specializing in the design and manufacture of long-range drones.

COMPETENCIES & CAPABILITIES

M3 Systems offers expertise, test & measurement software and tools to meet the needs of innovative GNSS applications.

Expertise

- Radio Navigation Engineering & Signal Processing
- GNSS Tests and Measurements solutions
- SDR (Software Defined Radio) GNSS Receiver
- ATM (Air Traffic Management) studies



M3 SYSTEMS

PRODUCTS & SERVICES

Products

- Stella NGC – GNSS test & measurement software suite
 - Stella NGC GNSS Signal Simulator (Multi-constellation, Multi-Frequency, Multi-antenna, 2 mobiles, IMU simulation, Multipath, Jamming, Spoofing)
 - Stella NGC Record and Playback (4 channels, Fine synchronization, AGC Auto, Smart I/Q Recorder)
 - Stella NGC Scenario Replayer (Manufacturing tool – EOL testing, Customized scenario)
- Boreal UAV – Fixed wing long range UAV
- e-TrackAir – Airport vehicle geolocation

MAJOR SPACE PROJECTS & REFERENCES

- EGNOS V3 SIGNAL MONITORING: KPI systems and Real time monitoring – Eutelsat
- ROC: Radio Occultation software testbed – CNES
- GNSS Spoofing test bench – CNES
- OBSIG: GNSS Signal Observatory – CNES
- KASSAV: GNSS Receiver error simulator for space launcher – CNES

POINT OF CONTACT

ADDRESS 26 rue du soleil levant
31410 Lavernose Lacasse France

WEBSITE www.m3systems.eu

PHONE +33 (0)5 62 23 10 80

POINT-OF-CONTACT : Marc POLLINA, CEO,
26 rue du Soleil levant, 31410 Lavernose Lacasse
marc.pollina@m3systems.eu, +336 11 43 55 92

TURNOVER 2,925 k €

WORK FORCE 37

SPACE TURNOVER 600 k €

SPACE WORK FORCE 7

Satellites
Ground segments
Transversal competencies



Magellium (Artal Group) is a Small & Medium Company offering solutions and services in Earth Observation all along the chain from sensors to value-added applications and Geographic Information Systems.

COMPETENCIES & CAPABILITIES

Magellium (Artal Group) has got 3 major competencies and capabilities:

- Earth Observation, a 40-staff department with solutions & services in sensor geometry modelling, radiometry calibration, Ground Segments development and thematic applications.
- Space Robotics and computer vision, a 12-engineer team having expertise in vision-based localization & navigation and other video and 3D processing techniques.
- Remote Sensing applications, a department where 20 engineers develop Space Data Infrastructures, data access portals, applications & decision support tools for end users.

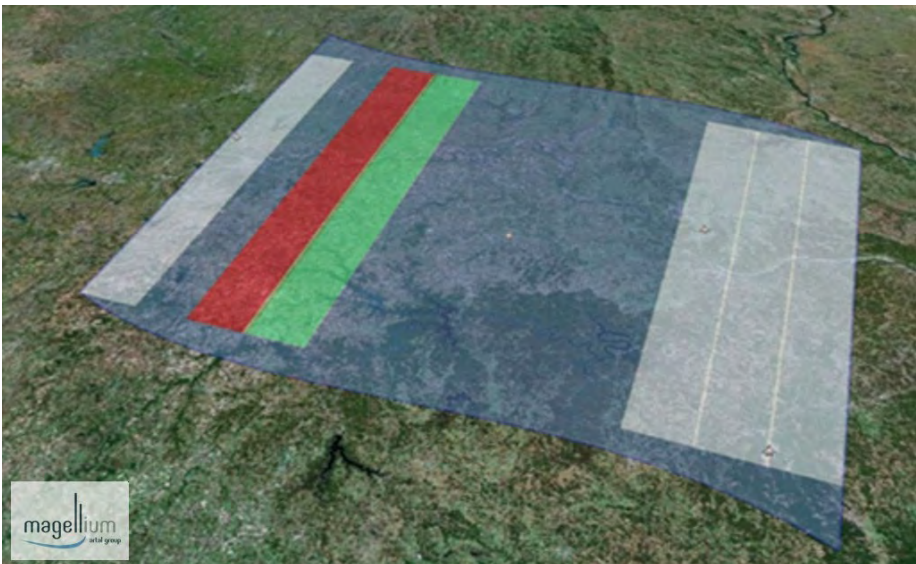

MAGELLIUM

PRODUCTS & SERVICES

Magellium's service portfolio goes from expertise, studies and specifications up to turn key developments, maintenance and in-orbit commissioning.

Magellium plays a role of software editor on behalf of CNES, IGN & DGA, and develops its own software solutions. The main products are:

- Euclidium®, a CNES & IGN workshop and set of libraries dedicated to sensor geometry modelling
- EDRES, a CNES solution for Space Robotics
- GEODEF suite (DGA), a set of libraries for geodesic purpose in Defence systems
- MagImageTools, a software toolbox belonging to Magellium and dedicated to satellite imagery processing
- INGRID² : a software platform for data and process capitalization, validation and experimentation, belonging to Magellium
- OrthoAdjust, a software solution for orthoimage and DEM production belonging to Magellium

MAJOR SPACE PROJECTS & REFERENCES

Involvement in the following space missions:

Pléiades HR, Spot6/7, Sentinel-2, Sentinel-3, CSO, Parasol, Merlin, Venus, Taranis, Spot World Heritage, Metop (IASI), Metop-SG (3MI & METImage instruments, IASI-NG), Pléiades Neo, Flex, MicroCarb, Trishna, Euclid.

Exomars: 15 years supporting CNES to develop the Vision Based Navigation which will fly with Exomars.

Rosetta/PHILAE: development & exploitation of a system combining ROLIS & CIVA images for a 3-D reconstruction of the comet and the location of PHILAE.

POINT OF CONTACT

ADDRESS 1 rue Ariane
31520 Ramonville Saint Agne (France)

WEBSITE www.magellium.com

PHONE +33 (0)5 62 24 70 00

POINT-OF-CONTACT : Lapeyre Alain, Senior Business Manager
alain.lapeyre@magellium.fr, +33 (0)6 89 57 05 11

TURNOVER 24 M€ in 2018

WORK FORCE 300 employees

SPACE TURNOVER 7 M€ in 2018

SPACE WORK FORCE 70 employees

Orbital systems
 Launchers
 Ground segments
 Transversal competencies



MaiaSpace is a European space tech company designing, operating and commercializing space transportation solutions for small spacecrafts. We are driven by the belief that space stands as a major enabler for a better and more sustainable life on Earth.

Our first and primary focus is on prototyping a reusable small launcher, building upon technologies and capabilities that bridge Newspace agility and Legacy space know-how.

We are open-minded, transparent, pragmatic, result oriented and definitely people centric.

COMPETENCIES & CAPABILITIES

MaiaSpace has capabilities and skills in the following areas

- Space launch services and operations for the smallsat market ;
- System engineering and mission analysis ;
- Rocket structural, avionics and propulsion ;
- Orbital space tug / platform engineering ;
- Assembly, Integration and Cryogenic testing.



MAIASPACE

PRODUCTS & SERVICES

MaiaSpace is selling 3 types of space related services, focused on the for the smallsat market:

- Launch services → from 2026 onwards
- In orbit logistics and services → from 2028 onwards
- Space Tech Test and Prototyping activities → active

MAJOR SPACE PROJECTS & REFERENCES

MaiaSpace has two main projects currently in portfolio:

- **A two-stage “minilauncher”**, featuring a reusable main stage. The rocket is designed around ArianeGroup’s Prometheus engine, with capacities tailored for the smallsat market, and is planned to be operated from Kourou
- **An orbital kick stage**, dubbed Colibri, which can offer a range of services in orbit, from simple rocket capability enhancement to more sophisticated features.

POINT OF CONTACT

ADDRESS Bâtiment A37 ArianeGroup, Forêt de Vernon
27200 Vernon France

WEBSITE www.maia-space.com

PHONE (email contact, please)

POINT-OF-CONTACT : Callari, Michael, CBO, michael.callari@maia-space.com

TURNOVER undisclosed

WORK FORCE 50-100

SPACE TURNOVER undisclosed

SPACE WORK FORCE 50-100

Transversal competencies



Development of passive thermal finishing coatings for the satellite and launcher industry, with a proven technological heritage, helping reduce risks for our customers.

Control of all thermal finishing stages, leading to better risk management: from product/process pairing design as far as manufacturing and implementation on flight parts.

COMPETENCIES & CAPABILITIES

Design, manufacturing and application of coatings for the space industry. ISO9001/EN9100 Certification; CNES-licenced products
We aim to ensure customer satisfaction, at the lowest cost and following regulations.

We are offering quality products, with a proven technological heritage, plus technological (ITAR/EAR free) and industrial independence (synthesis and manufacturing of our own raw materials), a clear sign of sustainability for our customers.



MAP SPACE COATINGS

PRODUCTS & SERVICES

MAP SPACE COATINGS solutions for the Space Industry:

- Low outgassing, thermal and electrical control coatings for inner and outer satellite parts,
- Low outgassing, thermally and electrically conductive adhesives,
- Low outgassing greases for satellite and launcher mechanisms,
- Low outgassing silicone conformal coatings to protect PCBs,
- White anti-static and anti-corrosion coatings for launchers.

Thermal finishing application Department (Clean rooms, Skilled space industry operators, Dedicated equipment and procedures).

Workshops and training sessions on applying our thermal control coatings. Physico-chemical characterization of our coatings.

MAJOR SPACE PROJECTS & REFERENCES

ACM 23, AEOLUS, AMOS5, ARABSAT 4, ARABSAT 5, ARSAT, ATV, AUSTRAL1N, CHINASAT, COROT, DEMETER, GALAXY 17, HOTBIRD 7A, IASI, INMARSAT 4, KA-SAT, KOREASAT, MEGHA-TROPIQUES, PHEBUS, PICARD, POSEIDON 3, PRISMA, RC1, ROCSAT 2, SENTINEL, SINOSAT (5,6), SIRAL, SMOS, SPIRALE, STAR 1 C2, SYRACUSE 3B, THAICOM 5, THEOS, YASHAT.

POINT OF CONTACT

ADDRESS Zi de Bonzom, 1 rue Paul Maes
09270 Mazères - France

WEBSITE www.map-coatings.com

PHONE +33 (0)5 34 01 27 00

POINT-OF-CONTACT: Carole Cornel - Sales Manager

TURNOVER

WORK FORCE 36

SPACE TURNOVER

SPACE WORK FORCE 30

Transversal competencies

MATRA ELECTRONIQUE offers you all services for the co-engineering and the manufacturing of space electronics, covering Scientific and Telecom Satellites including Robotic Exploration and Constellations.

This is based on our large heritage of:

- Electronics for SPACE & ESA missions: know-how since 1996, PID since 2012
- Electronics for NEWSPACE projects: from nanosatellites to large constellations since 2016
- Electronics for DEFENCE & MBDA missiles: since 1975

COMPETENCIES & CAPABILITIES

Co-engineering:

- PCB layout, mechanical drawing, test bench design & manufacturing

Manufacturing:

- Vapor phase, Selective wave, Hot air, CGA, Press-fit, Manual soldering
- Adhesive, Underfill, Conformal coating
- Visual inspection, Automatic Inspection (AOI, AXI)
- Test (FPT, JTAG), Integration, Environmental Test

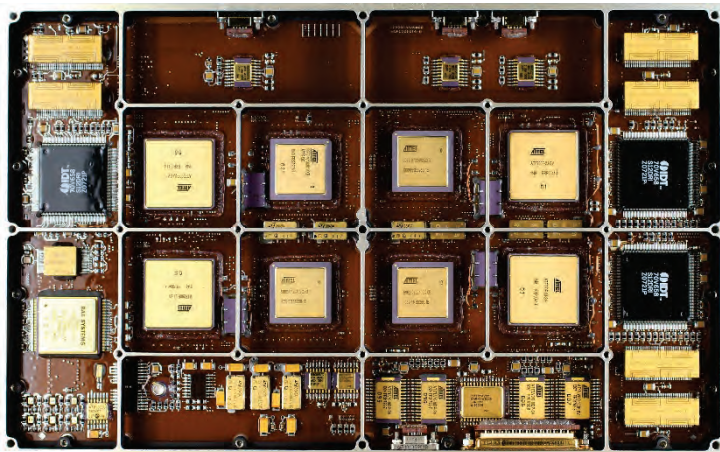

MATRA ELECTRONIQUE

PRODUCTS & SERVICES

Our services are achievable in independent or global solutions.

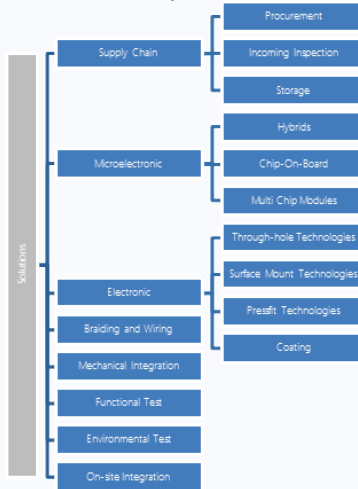

MAJOR SPACE PROJECTS & REFERENCES

Major space projects:

- EUROSTAR 3000, NEOSAT
- BEPI-COLOMBO, SOLAR ORBITER, EXOMARS, EUCLID, JUICE, IASI-NG, ESAIL, ASTRO-H, XARM, IXV, PROBA-V, PROBA-3, SENTINEL-1, MARS 2020, TARANIS
- ONEWEB

Major space references:

- CNES, ESA
- CNRS
- THALES ALENIA SPACE
- AIRBUS DEFENCE & SPACE
- AIRBUS ONEWEB SATELLITES

POINT OF CONTACT

ADDRESS Rue Ferdinand Meunier
60610 Lacroix Saint Ouen, France

WEBSITE www.matra-electronique.com

PHONE +33 (0)3 44 91 45 00

POINT-OF-CONTACT : RENAUT Frédéric, Sales & Business Development
frederic.renaut@matra-electronique.fr +33 (0)6 88 74 66 79

TURNOVER 95 M€

WORK FORCE 420

SPACE TURNOVER 5 M€

SPACE WORK FORCE 40

Orbital systems
 Launchers
 Satellites
 Balloons
 Transversal competencies



MECANO ID is a key partner in developing and manufacturing space structures, subsystems equipments and instruments.

For more than 25 years, MECANO ID has been supporting its customers from Space Telecommunications, Space Science, Earth Observation and Space Exploration fields in the development and manufacturing of predominantly mechanical and thermal systems, subjected to harsh environments and requiring effective and robust project management.

COMPETENCIES & CAPABILITIES

MECANO ID is based in Toulouse (France) in a 3000 m² dedicated with the following:

- Engineering team: 50 people specialized in mechanical and thermal architecture, design, mechanical sizing and thermal sizing. This team leads the development of space segment subsystems and also supports customers in engineering services.
- Space Manufacturing and Integration: Manufacture of spacecraft structures components or subsystems, especially in Composite. ISO 8 clean rooms dedicated to subsystems assembly and integration.
- Mechanical & thermal testing: Space environmental testing laboratory with vibrations, shocks, thermal, thermal vacuum and bake out means.

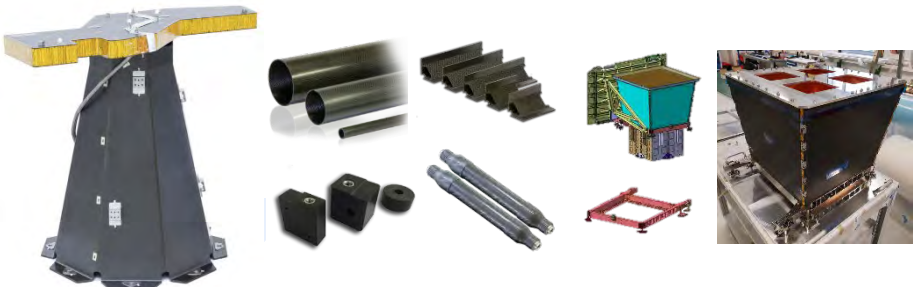

MECANO ID

PRODUCTS & SERVICES

Space products catalogue:

- Structural components (struts, tubes, brackets, inserts, etc.)
- Passive mechanisms (deployment joint, etc.)
- Composite RF components (waveguides, horns, etc.)
- Smallsat deployers EOS

Build to print: Manufacturing of composite parts with RTM or infusion processes: Carbon fiber, Glass fiber, Epoxy, etc. Manufacturing of equipments or instruments.

Build to Spec: Development of space structures, instruments or sub assemblies with global capability, from architecture to qualification tests.

Environmental Testing: Vibration (Sine, Random, Mixed mode...), shocks (SRS, Half sine, Sawtooth), thermal vacuum cycling and bake out.

Engineering support: Mechanical and thermal engineering.

MAJOR SPACE PROJECTS & REFERENCES

More than 25 years experienced in space sector:

- THALES ALENIA SPACE strategic partner for 25 years, part of the strategic suppliers program
- CNES referenced major supplier for mechanical engineering since 2006 and ESA direct supplier since 2007
- AIRBUS DS France strategic partner since 2013, part of the COMETES program
- Space Science, Exploration and Earth Observation programs: Exomars, Curiosity, Mars Sample Return, Mars 2020, Bepi Colombo, Metop SG, Solar Orbiter, GOCI II, etc.
- Space Telecom: Eutelsat 8WB, SGDC1, Arabsat6B, Telkom3S, Koreasat 5A et 7, HellaSat3, Eutelsat BB4A, Comsat-NG, Bangabandhu1, SES17, etc.

POINT OF CONTACT

ADDRESS 9 rue Paul Charrier 31100 Toulouse France

WEBSITE www.mecano-id.fr

PHONE +33 5 24 60 84 00

POINT-OF-CONTACT : Stéphane GALINIER, Business Development Manager
s.galinier@mecano-id.fr, +33 6 15 05 17 77

TURNOVER 9 M€

WORK FORCE 75

SPACE TURNOVER 8 M€

SPACE WORK FORCE 75

Transversal competencies



Created in 1989, **MEDES** is the **Institute for Space Medicine and Physiology**, a subsidiary of the French Space Agency (CNES) and Toulouse hospital.

The activities are focused on space physiology and medicine, clinical research and dual innovations, which may benefit both to space exploration and health, in particular in the field of digital Health.

MEDES staff combines multi-disciplinary experts with various skills from medical doctors, pharmacists, physiologists and nurses to IT Engineers and biomedical engineers.

COMPETENCIES & CAPABILITIES

Support for space missions: Expertise and services (i) to support space agencies for crew health maintenance - operational space medicine services (medical follow-up of astronauts), (ii) to support space experiments or technology demonstrations/evaluations in the field of health, (iii) to support astronaut medical selections.

Clinical studies: Conduct of complex clinical studies at international level, both for space and for the non-space field with studies to simulate the effects of weightlessness (e.g. Bed rest et dry immersion studies) in particular to evaluate countermeasures for international space agencies and various clinical studies to evaluate equipment or for medical research.

Application and innovations between Space and Health: Acceleration and promotion of innovations for Health on Earth and in Space, with a specific focus in the field of digital Health.



MEDES

PRODUCTS & SERVICES

- **Expertise and services in the field of space physiology and medicine**
 - * For astronaut medical selections
 - * For crew health maintenance (medical follow-up) in the frame of human spaceflights
 - * For performing advanced R&D thanks to space environment with services to support the design, preparation and performance of space experiments or technological evaluations in space in the field of health.
- **Expertise / services and infrastructure to support clinical research for space and for the non-space field.** MEDES operates a clinical research infrastructure (MEDES Space Clinic) with:
 - * Services to design clinical evaluations.
 - * Services / Infrastructure to perform clinical studies simulating the effects of weightlessness to evaluate countermeasures including physical, nutritional or pharmaceutical prevention means.
 - * Services / Infrastructure to perform clinical studies to evaluate equipment or for medical research purposes.
 - * Medical expertise to support companies willing to propose innovations in the field of health
- **Expertise and services to support innovations between space and health in particular in the field of digital health (project management, expertise and support for innovations in eHealth, telemedicine)**
- **Solutions to support flexible data collection including the DATAMIA solution (www.datamia.io)**

MAJOR SPACE PROJECTS & REFERENCES

- Weightlessness simulation / Dry immersion study. 2019.
- Weightlessness simulation / Bed rest “Cocktail” study. 2017.
- Participation to Proxima Space mission – 2017.
- Everywear – Mobile medical assistant - 2015-today.
- Deployment of a sustainable network of telemedicine in French Guiana- 2000-today.

POINT OF CONTACT

ADDRESS MEDES-IMPS / BP 74 404 - 31405 Toulouse Cedex 9 - France

WEBSITE www.medes.fr

PHONE +33 (0)5 34 31 96 00

POINT-OF-CONTACT : Berthier Audrey, Executive Director, MEDES
audrey.berthier@medes.fr, +33 (0)5 34 31 96 00

TURNOVER 3,8 M€

WORK FORCE 30 employees

Orbital systems
 Launchers
 Satellites
 Transversal competencies



Established in 1992, MEDYSYS is an engineering company specialized in mechanical, thermal and multiphysics FEA and analytical modeling. MEDYSYS is expert in simulation, design and optimization of mechanical systems.

Based on these fundamental skills, our business offering has been built along three complementary axis:

1. Computation and Simulation for industry
2. Development of specific scientific software or add-on to general FEA codes
3. Research and development

COMPETENCIES & CAPABILITIES

The main space competencies and capabilities of Medysys are:

- Low frequency vibration simulation Launcher
- Thermal and thermomechanical simulation
- Software development and methodologies (specific calculation tool)
- Multi-body dynamic simulation
- Composite material analysis tool
- Aerology data analysis



MEDYSYS

PRODUCTS & SERVICES

Independent SME serving the industry for 28 years:

- ✓ Simulation & Computation
- ✓ Software Development
- ✓ Innovation and R&D

MEDYSYS is also an innovative company with R&D certification for State credit (CIR and CII) and already leads innovation action on its own.

High-contrast micro-structured materials have been studied for spatial application last year over a R&T project with CNES. We demonstrated the theoretical acoustic behaviour of these materials and proved it by FE simulation

Our mechanical engineers can work in MEDYSYS design offices or as consultants on our customer site.

MAJOR SPACE PROJECTS & REFERENCES

MEDYSYS is a CNES supplier and participates in the framework contract on the structural dynamics activities.

Finite element calculations (ex: parametric vibration calculations on launchers), Development of scientific software (ex: improvement of structural modeling tools 3D for dynamics), Analysis of experimental data and statistical processing (ex: analyzes of natural environment data from the CSG area, notably wind databases for the CALLISTO project)

MEDYSYS has also worked on numerical simulation studies for the space industry for companies such as: SODERN, AIRLIQUIDE, REEL; Here are some examples of topics covered:

Mechanical and thermal studies of the netlander seismometer,
Dimensioning of equipment related to the handling of Ariane 6 sub-assemblies ...

POINT OF CONTACT

ADDRESS MEDYSYS, 8 Bis Boulevard Dubreuil, 91400 ORSAY, France

WEBSITE www.medysys.com

PHONE +33 6 76 36 88 53 / +33 1 69 33 24 30

POINT-OF-CONTACT : JACQ Yoann, Business Manager,
yoann.jacq@medysys.com, +33 6 76 36 88 53

TURNOVER 3 M€

WORK FORCE 40

SPACE TURNOVER 0,8 M€

SPACE WORK FORCE 8

Satellites
Transversal competencies



Specialized into laser surface preparation / decoating with robotic solution for metallic and composites materials.

COMPETENCIES & CAPABILITIES

Surface preparation before bonding onto aluminum and composites CFRP.

Automatisation with Cobot/Robot with 3D, AI, process control

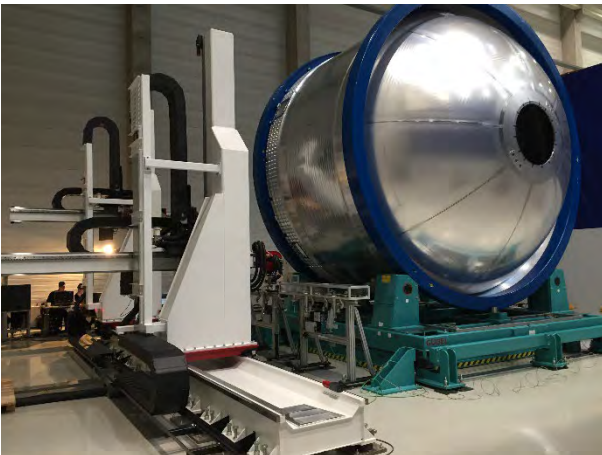

MELIAD

PRODUCTS & SERVICES

We provide studies, qualification TRL support for our customer in the way to qualify our laser technology onto metallic and composites for laser surface preparation before bonding, but also for laser surface decoating for mirroring (electric bonding consideration).

At the end, we provide a service onsite with mobile laser mobile or a fully automated solution to be integrated onto customer fields.

We also provide manual cleaning on site.

MAJOR SPACE PROJECTS & REFERENCES

Ariane 5ME – Ariane 6: development, qualification, and integration of robotic laser surface preparation before bonding onto Aluminum tanks.

Ariane 6: Automatic solution for laser surface preparation onto Aluminum and Steel components before painting.

Space companies: laser surface preparation onto Aluminum panels before bonding

POINT OF CONTACT

ADDRESS : 6, Rue des Orfèvres – 44480 Les Sorinières

WEBSITE www.meliad-sas.com

PHONE +33 (0)2 51 70 38 21

POINT-OF-CONTACT : Duchazeaubeneix, Jean, CEO,
jm.duchazeaubeneix@meliad-sas.com, +33 6 86 48 51 69

TURNOVER 3 M€

WORK FORCE 15 employees

SPACE TURNOVER 0.8 M€

SPACE WORK FORCE 3 employees

Satellites
Tranversal competencies



MERSEN BOOSTEC's activities are based on the manufacture of sintered silicon carbide parts. This material called Boostec[®] SiC brings original solutions to markets as diverse as space, astronomy, laser processes, semiconductor/optomechanical OEMs and chemical industries.

COMPETENCIES & CAPABILITIES

MERSEN BOOSTEC provides SiC mirrors, SiC stable structures and also focal plane hardware for telescopes to be used in space or on ground. Thanks to the combination of very high specific stiffness and high thermal stability, Boostec[®] SiC provides the very high thermoelastic stability required for optical instruments on board satellites.

MERSEN BOOSTEC offers assistance to its customers for the design of their SiC parts to ensure better feasibility, mitigate risks and also reduce costs and lead time.

MERSEN BOOSTEC has developed over the years a unique expertise and capacity to manufacture space-quality SiC parts up to Ø 3.50m.

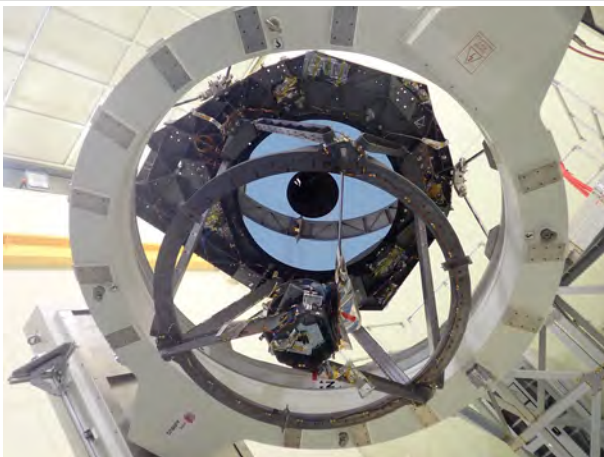

Euclid full-SiC telescope – Image courtesy of Airbus D&S

MERSEN BOOSTEC

PRODUCTS & SERVICES

SiC Products:

- Mirrors including optional SiC CVD coating on the optical face, up to Ø 3.50 m,
- Highly stable structure elements; 4-meters-class structure assemblies obtained by brazing, gluing and/or bolting,
- Detector supports and other focal plane hardware,
- Full-SiC telescopes.

Services:

- Assistance to the design,
- Quality in conformance with ESA ECSSs,
- Mechanical proof-tests.

MAJOR SPACE PROJECTS & REFERENCES

Sciences of the Universe:

ROSETTA Osiris Narrow Angle Camera, HERSCHEL telescope, GAIA Payload Module, NIRSpec JWST, EUCLID (main telescope, VIS and NISP instruments)

Earth Observation:

Space Lidars (Aladin AEOLUS, Atlid EARTH CARE), METOP-SG-A (IASI-NG, METImage derotator), MICROCARB, Multispectral Imagery (SENTINEL-2, PLEIADES and CSO focal planes), NAOMI telescopes developed for Airbus export and for AIRBUS DS Intelligence use.

POINT OF CONTACT

ADDRESS MERSEN BOOSTEC, ZAE Ceram'Innov Pyrénées
65 460 Bazet, France

WEBSITE www.mersen.com

PHONE +33 (0)5 62 33 45 00

POINT-OF-CONTACT : MALLET Florent, Sales / Projects Manager
florent.mallet@mersen.com +33 (0)5 62 33 45 03

TURNOVER 13 M€

WORK FORCE 90

SPACE TURNOVER 7 M€

SPACE WORK FORCE 50

Ground segments
Satellites
Transversal competencies



Metravib Engineering, a European leading company in vibroacoustic engineering, has demonstrated high expertise in design of passive and active solutions to minimize noise and vibrations, and deep understanding of related physics. Most of technologies used to attenuate shocks or solve vibration problems are based on mechanical and viscoelastic material solutions for damping, isolating or absorbing energy, possibly including metamaterials, as validated and recommended by Metravib.

COMPETENCIES & CAPABILITIES

Launchers induce high acoustic levels, shocks and vibration that increase payload damage risk. On observation satellites for instance, instrument pointing accuracy may strongly depend on micro vibrations disturbance. Mastering vibration & acoustic parameters and providing effective solutions are thus key-factor for the success of any mission.

Metravib Engineering know-how includes design methodologies (computational analysis, heritage synthesis), software and mechanical solution development, experimental capabilities to supply qualified/flight proven solutions, and tight connection with material characterization (SPACEMAT, material database dedicated to space applications).

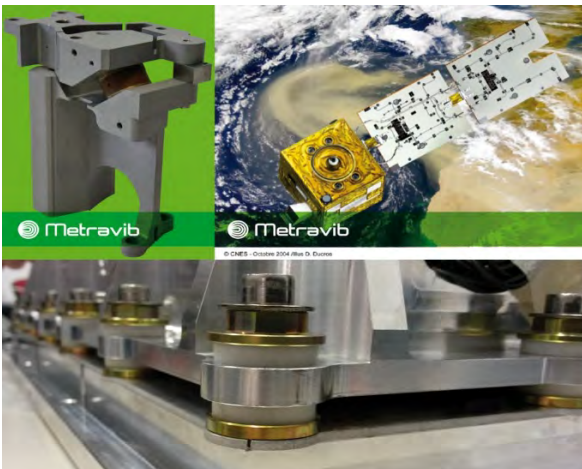

METRAVIB ENGINEERING

PRODUCTS & SERVICES

Equipment protection (during launch phase and orbital life):

Micro vibrations Isolators (Soft mounts on metallic frame).

Shock attenuators (Viscoelastic rings at the interface with metallic support on existing standards, including adaptation to various needs in terms of frequency and performance).

Protection of ground sensitive structures facing most severe vibration and acoustic environment.

Structure improvement:

Dynamic absorbers (Tuned system with damped stiffness + resonant mass).

Damped trusses (Strut insert on structure, introducing suitable damping effect).

Lightweight structures based on metamaterials technologies possibly enhancing shock reduction and vibration damping properties.

Deployment mechanisms:

MAEVA Hinges (Self-motorized and blocking device qualified and approved on several flights).

Software development:

Micro vibration calculation (in-orbit optical sensor performance qualification).

Vibroacoustic calculation (ASTRYD software: payload, onboard systems and components resistance to acoustic load).

MAJOR SPACE PROJECTS & REFERENCES

- ELA4 (Launch Pad Vibroacoustic modelling)
- ESAIL Project - supply of deployment mechanisms
- IASI-METOP1 & 2 vibrations damping solutions (military)
- INTEGRAL, HERSCHEL PLANCK, METOP vibroacoustic calculations
- GAIA (MAIT TVIS microvibrations insulation)
- DUMSAT (suspended mass on metallic blades)
- SPACE BUS (Eurasiasat / Stentor Missions)
- ARD on Ariane 503
- ENVISAT (MERIS equipment damping)
- CASSIOPEE-MIR (CASTOR Experiment)
- MYRIADE Microsatellite platform - vibration damping issues (Demeter, Parasol, Picard, Spirale, Mistigri, Vnred)
- PROBA2, MICROSCOPE, TARANIS

POINT OF CONTACT

ADDRESS 200 chemin des Ormeaux | F-69578 - Limonest Cedex – France

WEBSITE metravib-engineering.com

PHONE +33 (0)6 79 86 26 45/+33 (0)4 78 66 34 10

POINT-OF-CONTACT: Daniel Vaucher de la Croix
daniel.vaucherdelaCroix@acoem.com

TURNOVER (ACOEM / METRAVIB) €100m / €12m

WORK FORCE (ACOEM / METRAVIB) 700 / 75

SPACE TURNOVER 2M€ (Aerospace & Defense)

Orbital systems
 Launchers
 Satellites
 Transversal competencies



French SME: More than 50 years as **subcontractor expert in custom hermetic sealing & hermetic interconnections** for harsh environment (pressure, intensity, tension, temperature, etc...) and **Pure Gold Electroplating** for space environment.

Design and production of prototypes, small and medium series, **based on customer technical specifications.**
 Small size of pieces (Ø 0,2 mm up to 150 mm)

COMPETENCIES & CAPABILITIES

- **Glass to Metal seal** (including dilver P1 (kovar) and titanium) and **high and low temperature brazing** (ceramic, sapphire, etc...)
- Hermeticity: **Leak rate less than 10^{-8} mbar.l/s**
- Electric isolation: Isolation resistance over 10 GΩ
- Breakdown voltag : from 500 to 3000 V
- Pressure: up to **3000 bars**
- Operating temperature: **from -180°C to +300°C** (according to coating)
- Precious metal electroplating process; Our expertise: Selective custom work (savings), total deposit. Expert in high thicknesses in gold plating (up to 100µm) and silver plating (up to 500µm)

Glass to metal sealing & brazing are complementary technologies

Supercam LASER

Sapphire window brazed on Titanium



Glass to metal sealing interconnection 18 pin hermetic feedthrough

MICRONOR

PRODUCTS & SERVICES

- Products : feedthroughs, electronic packages, sensors, relay bases, connectors, isolators, igniters bases,
- Base and **Precious metal electroplating processes** (gold, silver) and common metal (tin, copper) for industrial applications (space, defense, etc...) – specific **99.99% pure gold electroplating** process for space application

Alkaline copper plating & Acid copper

Nickel-plating sulfamate & Bright Nickel

Silver plating

Direct gilding on stainless steel

Gilding (indirect) on molybdenum

Cobalt doped gold; Nickel doped gold, Pure space gold, 18K alloy gold

Tin-Lead & pure Tin

MAJOR SPACE PROJECTS & REFERENCES

- Hermetic brazing of the sapphire window for the perseverance's chemcam & lasercam (Thalès)
- Hermetic 18 pin feedthroughs connectic plate for the rover Perseverance
- Hermetic feedthroughs for pyrotechnic systems of Ariane 5 &6 rocket (Dassault)
- Gold electroplating for aluminium parts (Mirion,TAS)

POINT OF CONTACT

ADDRESS 62 boulevard de Beaubourg
77184 Emerainville – France

WEBSITE www.micronor.fr

PHONE +33 (0)1 60 17 60 60

POINT-OF-CONTACT Xuan DANG, technical partnership manager,
xuan.dang@micronor.fr, + 33 6 08 90 35 53

TURNOVER 9 M€

WORK FORCE 48

SPACE TURNOVER 2 M€

SPACE WORK FORCE 22

Launchers
 Satellites
 Ground segments
 Balloons
 Transversal competencies



MICROTEC is specialized in large scale production of high reliability electronics for space & aeronautic.

COMPETENCIES & CAPABILITIES

- Design, Validation, Industrialization, Manufacturing & Operational Maintenance of High Reliability Electronics for AeroSpace
- Design, validation & industrialization: 23 people
- Hardware & Software, from mock-up to flight model, & EGSE
- Industrialization: 6 people
- Manufacturing: 70 people, including 27 people in clean room
- Maintenance: 4 people
- Clean room (ISO8-9): 400m² + 200m² automated line for electronics board assembly

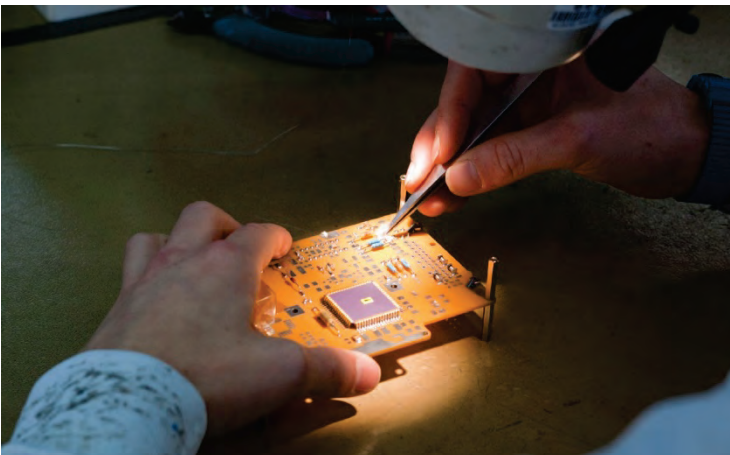

MICROTEC

PRODUCTS & SERVICES

- Design: electronics for scientific instrumentation & DCDC converters for telecom
- Validation: design & manufacturing of EGSE, environmental qualifications
- Industrialization: design of PCB compliant with ECSS, integration - Design-to-cost, design-to-manufacture & design-to-test
- Manufacturing compliant with ECSS: electronic flight model board & equipment. Assembly, control, burning, coating, functional testing. Delivery with qualification for flight.
- Operational Maintenance (aeronautics)

MAJOR SPACE PROJECTS & REFERENCES

- IRIDIUM NEXT: 2,430 electronic boards EPC & 2,430 radiating panels O3B, GLOBAL STAR
- Monthly: 150 up to 250 electronic space devices produced for Thales Alenia Space

POINT OF CONTACT

ADDRESS 10 rue Hermès
31520 Ramonville saint agne

WEBSITE www.microtec-agera.fr

PHONE +33 (0)5 61 39 11 39

POINT-OF-CONTACT: Vincent Gayde – vincent.gayde@microtec-agera.fr
Pascal Mexé – pascal.mexe@microtec-agera.fr

TURNOVER €9,7m

WORK FORCE 110

SPACE TURNOVER €4m

SPACE WORK FORCE 40

Ground segments
Transversal competencies



Miratlas provides complete characterization of optical atmospheric conditions including cloud and absorption but also turbulence by night and by day.

Our integrated sky monitor offers a comprehensive array of passive optical sensors with all the functionalities necessary for robotic telescope operation and is designed to operate continuously without maintenance.

The data is readily available through online subscription via a comprehensive dashboard.

COMPETENCIES & CAPABILITIES

Comprehensive atmospheric characterization according to the CCSDS recommendations for optical comms:

- Cloud cover imager, high resolution visible and thermal cameras
- DIMM (night) and SHABAR (day) turbulence measurements
- Weatherproof Alt/Az tracking mount
- Physical atmospheric modelling of turbulence



MIRATLAS

PRODUCTS & SERVICES

The Integrated Sky Monitor is available both as a product or as a service. The configuration is modular according to the parameters required as well as the location of the installation site.

It is designed to inform the number, location and operations of the ground segment gateways by providing:

- Site survey
- Laser Communication Terminal design information
- Minimum number of sites necessary to ensure sufficient diversity.
- LCT operations and handovers optimization

MAJOR SPACE PROJECTS & REFERENCES

Miratlas is involved in numerous collaborations including:

- CNES on optical feeder link for GEO satellite with Airbus, Thales, Cailabs, Alpao etc.
- ONERA on cloud and turbulence measurements
- CAI Durham on atmospheric modelling

Our customers include:

- NASA CDSOC, DLR, Airbus, KSAT, RAS SAO, USTC

POINT OF CONTACT

ADDRESS 139 rue Philippe de Girard
84120 Pertuis, France

WEBSITE www.miratlas.com

PHONE +33 (0)6 51 14 73 82

POINT-OF-CONTACT Communal, Jean-Edouard, Co-founder & CEO
jec@miratlas.com, +33 6 51 14 73 82

TURNOVER

WORK FORCE 18 employees

SPACE TURNOVER

SPACE WORK FORCE 18 employees

- Orbital systems
- Launchers
- Satellites
- Ground segments
- Balloons
- Transversal competencies



The Microwave Vision Group offers cutting-edge technologies for the visualisation of electromagnetic waves. Enhancing the speed and accuracy of wireless connectivity testing, as well as the performance and reliability of anechoic and EMC technologies, our systems are integral to meeting the testing challenges of a fully connected world.

COMPETENCIES & CAPABILITIES

- Antennas
- Electromagnetic compatibility
- Electronics
- Radiofrequencies



MVG (SATIMO)

PRODUCTS & SERVICES

- Production of electromagnetic wave imaging systems
- Innovative Antennas / Reference Antennas
- Electromagnetic compatibility testing of systems
- OTA (TRP/TIS) Measurement service
- Passive antenna measurement service

MAJOR SPACE PROJECTS & REFERENCES

- Production, delivery and installation of an innovative Antenna Measurement system (Starlab 50GHz) to the CNES Toulouse.

Contact at CNES Toulouse:

Mme Lise Feat

Mr Daniel Belot

Mr Anthony Bellion

<https://phototheque.cnes.fr/cnes/search.do?q=starlab>

- Production and delivery of reference Antennas to the CNES Toulouse

DSO/RF/AN

Bât Lagrange Sud 141

18 Avenue Edouard Belin

31400 Toulouse

POINT OF CONTACT

ADDRESS 13 rue du Zéphyr
91140 Villejust France

WEBSITE www.mvg-world.com

PHONE +33 (0)1 69 29 81 60

POINT-OF-CONTACT : QUINQUIRY, Alain, Regional Sales Manager
alain.quinquiry@mvg-world.com, +33 (0)6 30 44 20 43

TURNOVER 100 M€

WORK FORCE 300 employees

SPACE TURNOVER 1 M€

SPACE WORK FORCE 10 employees

Transversal competencies



NanoXplore is a privately owned fabless company based in France. The company was created in 2010 by three veterans of semiconductor industry with long experience in the design, test and debugging of FPGA. The founders of NanoXplore were amongst the pioneers of custom FPGA based emulation systems and IP macros for embedded FPGA cores. In 2006 they developed a new family of FPGA devices with 750K four-input LUTs implemented in a 65nm technology.

Based on his team's long standing FPGA development track record, NanoXplore has designed a leading radiation hardened FPGA portfolio for aerospace, defense and industrial market.

COMPETENCIES & CAPABILITIES

NanoXplore competencies & capabilities are:

- Programmable Logic Devices,
- VHDL & Verilog design,
- High-Speed Serial Links,
- IP core development,
- Radiations Effects on Components & Systems,
- Electronic Packaging,
- Space & Military quality standards
- Etc.

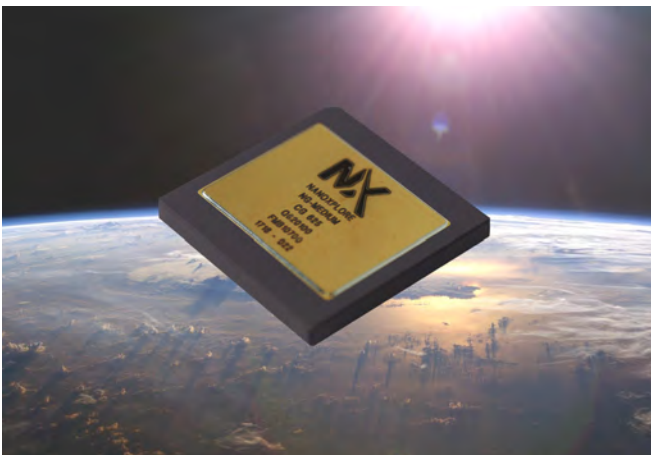

NANOXPLORE

PRODUCTS & SERVICES

NanoXplore develops Radiation-Hardened By Design Sram-based FPGA components for use in any spaceborne applications starting with Low-end FPGA to High-end FPGA System-On-Chip.

Since FPGAs are standard components, being programmable, even reprogrammable, these devices can be implemented in basically all electronic systems. The programming is done with our Software tool suite named NXmap.

Since those components are complex, full technical support is done by NanoXplore themselves as well as by franchised distributors.

MAJOR SPACE PROJECTS & REFERENCES

NanoXplore is involved in many Space projects, either from Space Agencies and Europeans organizations as well as from Prime Contractors and Subcontractors.

Hereafter a very short list of projects where NX involved:

- SVOM mission
- Floripasat
- Galileo Second Generation,
- Etc.

POINT OF CONTACT

ADDRESS 1 avenue de la Cristallerie
92310 SEVRES - France

WEBSITE www.nanoxplore.com

PHONE +33 (0)1 77 87 00 48

POINT-OF-CONTACT : Joel LEMAUFF – Head of Marketing & Sales –
+33 (0)6 8382 0053 – joel.lemauff@nanoxplore.com

TURNOVER

WORK FORCE

SPACE TURNOVER

SPACE WORK FORCE

Orbital systems
 Launchers
 Balloons
 Transversal competencies



Nerys designs solutions allowing to test your equipment under real life conditions and to measure its behavior. Nerys intervene during R&D, design & development, qualification, pre-marketing, production and maintenance phases.

Nerys is a multi-disciplinary team capable of providing project management to test equipment, ranging from the simplest to the most complex, in several domains (aerospace, industry, automotive, defense).

COMPETENCIES & CAPABILITIES

- Project management (Quality, documentations, risks management, subcontractors management, ...).
- System engineering: IT, electronic, electrical and mechanical design (specifications, analysis, schematics, CAD, definition files, design justification files, testing, qualification & acceptance plans).
- Development (electronic PCB design, FPGA, embedded and applicative software's,).
- Manufacturing (FAI, raw material traceability): electronic boards, mechanical housings, harness, integration
- Qualification in environmental conditions: mechanical, thermal, EMC/ESD, pressure.



NERYS

PRODUCTS & SERVICES

Nerys' role is to provide you with autonomy and precision in your test campaign due to complete, tailor-made solutions (bench testing, electrical engineering units, computer "workstation" and software).

Our versatility and know-how as an integrator enable us to be an important factor during each stage of your testing process. We are able to:

- Define the test strategy adapted to your product, your business sector... (specifications, diagnosis).
- Designing and building a complete test facility (CAD, bench manufacturing, electrical engineering, data acquisition system, PC and data processing and control software ...).
- Modernize, complete or maintain an existing installation (instrumentation, test software, mechanical retrofit, electrical engineering).
- Develop measurement systems (instrumentation, data acquisition systems, on-board systems).
- Team training.

MAJOR SPACE PROJECTS & REFERENCES

Active & customized instrumentation equipment embedded on ArianeGroup launchers allowing mainly to manage:

Hi-rel sensors (strength, pressure, temperature, inertial central, ...)

Imaging processing (JPEG2000, CAMLINK, ...)

Data encryption (AES)

Radiofrequency communications

Low energy consumption

POINT OF CONTACT

ADDRESS Pôle d'activités Yvon MORANDAT- 1480, Avenue d'Arménie
13120 Gardanne - France

WEBSITE www.nerysgroup.com

PHONE +33 (0)4 42 24 52 00

POINT-OF-CONTACT : GARRON MELLET Stéphanie, in charge of customer relationships, stephanie.garron@nerysgroup.com, 04 42 24 52 01

TURNOVER 1 500 000 €

WORK FORCE 15 employees

SPACE TURNOVER 600 000 €

SPACE WORK FORCE 4.5 employees

Orbital systems
Transversal competencies

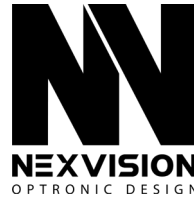

Nexvision is an optronics design house specialized in the design & production of embedded vision systems requiring high computing power up to 1000 Tops on 100 Gbits/s data stream, image sensors in all frequency bands and the fusion of different imagers technologies (video camera, radar, lidar). We design complete electronic systems, including the development of advanced image processing and analysis algorithms.

COMPETENCIES & CAPABILITIES

Our Engineering team masters the entire vision system architecture :

- Image sensors integration in multi-spectral band (UV, visible, night/VNIR, SWIR, Thermal MWIR & LWIR, Terahertz)
- High Performance Computing embedded electronic design (CPU/GPU/NPU/FPGA : Nvidia AGX orin, Xilinx Ultrascale+/Versal)
- Image processing & analysis software (you can find out our algorithms' library here : <http://nexvision.fr/solutions/modules/ip-core-fpga-libraries/>)
- Video streaming, video over IP & high speed real time transmission
- Photonics and optical design
- Electro-mechanical design



NEXVISION

PRODUCTS & SERVICES

Our Engineering team masters the entire vision system architecture :

- Image sensors integration in multi-spectral band (UV, visible, night/VNIR, SWIR, Thermal MWIR & LWIR, Terahertz)
- High Performance Computing embedded electronic design (CPU/GPU/NPU/FPGA : Nvidia AGX orin, Xilinx Ultrascale+/Versal)
- Image processing & analysis software (you can find out our algorithms' library here : <http://nexvision.fr/solutions/modules/ip-core-fpga-libraries/>)
- Video streaming, video over IP & high speed real time transmission
- Photonics and optical design
- Electro-mechanical design

MAJOR SPACE PROJECTS & REFERENCES

For the past 4 years, Nexvision has been designing innovative on-board image processing electronics for LEO satellites and earth observation optronics (ex : DARWIN & ISAAC projects for CNES).

POINT OF CONTACT

ADDRESS Parc SWEN Sud - Bât. D2 Hall D4, 1, Bd de l'Océan - Imp. Paradou
13 009 Marseille - France

WEBSITE www.nexvision.fr

PHONE +33 (0)6 30 36 08 28

POINT-OF-CONTACT : CARRIER, Vincent, CEO, vincent.carrier@nexvision.fr

TURNOVER 3 M€

WORK FORCE 25 engineers

SPACE TURNOVER 0.8 M€

SPACE WORK FORCE 8 engineers

Transversal competencies



Where there is electromagnetism, NEXIO has a role to play. NEXIO turns electromagnetic waves and their EMC/RF/LIGHTNING/RCS constraints into added value for major groups, SMEs and VSEs in 30 countries. NEXIO is organized into 3 business divisions: Services-Engineering, Test Automation, Simulation software and 2 Innovation and Training transverse centers.

NEXIO is based in Toulouse, Paris, Lyon-Grenoble, Munich, Austin and Shanghai.

COMPETENCIES & CAPABILITIES

Our products and services cover all phases of electronic product development, from design to qualification, in the Aerospace, Spatial, Automotive sectors as well as the Electronics Industry.

NEXIO offers a platform of unique electromagnetic services. We have a team of more than 80 technicians, engineers and doctors able to handle all types of issues oriented: test, design and simulation in EMC, lightning RF and HYPER.

Our specialists are involved in short studies, innovation projects or long-term services. Using if necessary, NEXIO's laboratories for measurement or major simulation software and cluster capabilities.

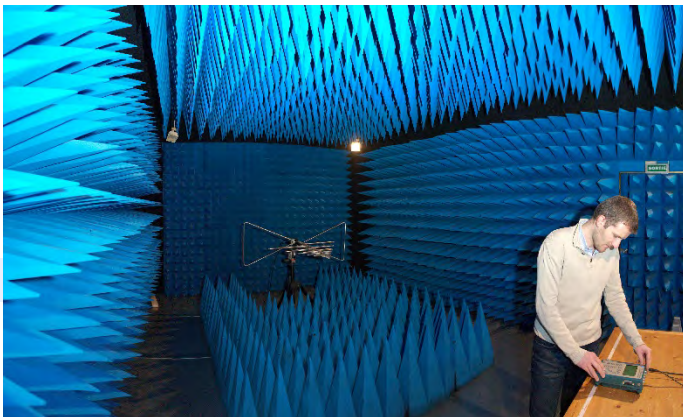

One of the NEXIO's EMC Test Lab for Tuning, Optimisation or Qualification.

NEXIO

PRODUCTS & SERVICES

As for its services, NEXIO is the only Software Company that covers both measurement and simulation.

Concerning Test and Measurement, NEXIO offers, BAT, the market's widest range and the high-performance automation test software for a EMC and RF testing requirements for all industries. Its flagship BAT-EMC software is the leader in EMC automation software in France, Germany and USA.

Concerning Simulation, NEXIO offers an Electromagnetic Simulation Software range, CAPITOLE-EM. Its RF module is dedicated for antenna design and positioning. Its RSC module is choice by MOD for furtivity study.

With BAT-SCANNER, NEXIO use the near field measurement and robotic to helps the design of electronic circuits by evaluating their behaviour in terms of EMC. With its innovate phase measurement technology, the result of BAT-SCANNER is used in software simulation.

Our software are offered through a world network of support staff and sales representatives.

MAJOR SPACE PROJECTS & REFERENCES

ENGINEERING & TEST for CNES, AIRBUS D&S, THALES AS, ARIANE GROUP, INTESPACE, STEEL ELECTRONIQUE...

- EMC Expertise on equipment, system and satellite
- RF antennas design and characterization
- EMC and RF tests on demand or in customer laboratory
- EMC / Lightning study and simulation on launcher
- EMC equipment analyses, drafting of specifications, numerical simulations (ESD, mass networks, magnetics)
- Design of microwave Integrated Circuits
- Charging simulation and analyses

INNOVATION with ESA, CNES, DGA, AIRBUS D&S, ARIANE GROUP ..., in the frame of FUI, R&T CNES, ESA ITI, RAPID DGA in topics:

- EMC characterization by Near-Field Scan
- Fast EMC simulation
- New method of antenna modelling

POINT OF CONTACT

ADDRESS NEXIO - 48 rue René Sentenac
31300 TOULOUSE France

WEBSITE www.nexiogroup.com

PHONE +33 (0)5 61 44 02 47

POINT-OF-CONTACT : DELHOUME, Nicolas, Business Developer,
nicolas.delhoume@nexiogroup.com +33 (0)6 82 83 62 87

TURNOVER 6,3 M€ (2019)

WORK FORCE 75

SPACE TURNOVER 1 M€ per year

SPACE WORK FORCE 12

Launchers
Satellites
Transversal competencies



Nexter Munitions has been developing, manufacturing and marketing pyrotechnic components and actuators for over 100 years. Thanks to its recognized know-how and experience in this field of activity. Nexter Munitions meets the highest requirement of defense, aeronautical, space and civil applications. Today, Nexter Munitions (facilities located in Tarbes) a major European in this sector, is one of the few manufacturers of primary explosive

COMPETENCIES & CAPABILITIES

Nexter Munitions has recognized expertise areas of mechanics, formulation of energetic materials, detonics and ballistics. We are able to manufacture from few dozen prototypes to 200 000 units per day, meet complex specifications : defense, aeronautics and space, resistance to extreme accelerations and environments, take into account the highest requirement of safety and reliability, design components with a demonstrated lifetime up to 25 Years



NEXTER MUNITIONS

PRODUCTS & SERVICES

Formulation of new energetic materials, miniaturisation of components and systems, optopyrotechnics igniters and detonations, slappers, MEMs

Computation codes in ultra fast dynamics, thermodynamics, digital simulation, modelling.

Unique in Europe ; synthesis of primary explosive with safety system, computer assisted bridge wire welding; loading and assembly means, statistical process control, cold pressing workshop, hermeticity of products ensured by laser welding process.

MAJOR SPACE PROJECTS & REFERENCES

- ARIANE 5 : SELF DESTRUCT DETONATOR
- ARIANE 6 : OPTO-PYROTECHNIC DETONATOR & PYROACTUATOR

POINT OF CONTACT

ADDRESS : 13 Bis Chemin des Poudrières
65 000 Tarbes, France

WEBSITE www.nexter-group.fr

PHONE +33 (0)5 62 53 01 00

POINT-OF-CONTACT: Alexandre THARREAU, B2B Sales Manager
a.tharreau@nexter-group.fr +33 7 64 79 99 14

TURNOVER 320 M€

WORK FORCE 750

SPACE TURNOVER 3 M€

SPACE WORK FORCE 8



Transversal competencies

Nicomatic is a French company with 44 years' experience in designing and manufacturing connectors & specific solutions for harsh environments.

- ✓ Full in-house manufacturing & design results in high quality products,
- ✓ Short term deliveries with 98% on time delivery,
- ✓ Innovative spirit & high degree of specialization,
- ✓ Working with all the world class leaders in industry, defense & aerospace

COMPETENCIES & CAPABILITIES

Nicomatic offers a wide range of interconnexions solutions: catalogue products (20 million of possible configurations) and customized solutions designed by our dedicated team to support your design activity.

Indeed, Nicomatic can support your projects from the design to the qualification.

We can also offer extra services such as:

- ✓ R&D studies,
- ✓ Mock-up production,
- ✓ Laboratory tests and qualification
- ✓ Specifics assemblies



NICOMATIC

PRODUCTS & SERVICES

“**Inside of the box**” connectors:

- ✓ Board to wire connectors with mixed layout (Low frequency, High Power, Coaxial contacts)
- ✓ Board to Board solution,

“**Outside of the box**” connectors:

- ✓ Metal or composite connectors for EMC/EMI enhanced performances (DMM/DLMM series), EN qualification in progress
- ✓ Modular solutions based on EN4165 standard

Services: Harnessing, cable assemblies, specific developments, Integrated solutions (customer tapes, test bench...), testing sessions in our internal laboratory, ...

MAJOR SPACE PROJECTS & REFERENCES

Exomars,
Jade Rabbit,
Nanosat 01B,
DubaiSat,
Vega launcher,
Ariane 6,
Lunar landing system,
Horizon 2020 programs,
Space Inspire programs,
And many other New Space programs,
...

POINT OF CONTACT

ADDRESS Nicomatic ZI Les Bracots – 173 Rue des Fougères
74890 Bons en Chablais France

WEBSITE www.nicomatic.fr

PHONE +33 (0)4 50 36 13 85

POINT-OF-CONTACT : MESSORI, Christophe, International Key Account Manager
c.messori@nicomatic.fr, 06 84 93 61 66

TURNOVER 45 M€

WORK FORCE 350

SPACE TURNOVER

SPACE WORK FORCE

Satellites
Transversal competencies



Founded in 2008, Nimesis relies on a technical know-how of more than 30 years in the field of shape memory alloys (SMA).

Nimesis develops, designs, and produces actuators, thermal safety devices and other smart devices for the industry.

Dedicated to the business development of the SMA Technology and leader in the field of smart space actuators, Nimesis is also present in other fields, such as biomedical, nuclear, aeronautics, defense, automotive and luxury watchmaking.

COMPETENCIES & CAPABILITIES

- Expertise in the technology of shape memory alloys
- Unique know-how, highly specialized skills
- Patented processes
- European leader in the development of devices using SMA for different industries.
- R&D and manufacturing means, from elaboration to assembly in clean room
- Expert in projects monitoring (from feasibility study to product delivery)
- Expertise in 4D printing



Triggy® TRHT02

NIMESIS TECHNOLOGY

PRODUCTS & SERVICES

Nimesis developed and implemented a series of new actuators, mainly for the space industry. They are considered as the perfect solution for deployment, locking, unlocking, release or dismantlement of spacecraft mechanisms, and can be described as follows:

<p>TRIGGY® is our off-the-shelf product, used for the deployment, locking, unlocking, release or dismantlement of spacecraft mechanisms:</p> <ul style="list-style-type: none">➤ Compatible with HDRM (Hold Down Release Mechanisms)➤ Triggering time: 30 to 300 sec➤ Triggering temperature up to 230°C➤ In Orbit operational temperature range: from -120°C to +120°C➤ Preload up to 60 kN	<p>Pinloader, still under development is a new auto-resettable smart actuator to deploy, lock unlock, release spacecraft mechanisms:</p> <ul style="list-style-type: none">➤ Compatible with HDRM➤ Triggering time: 30 to 90 sec➤ Triggering temperature up to 230°C; select your own triggering temperature from 0°C to 230°C➤ In Orbit Operational Temperature range - 120°C to +120°C	<p>Other HDRMs (Hold down and release mechanism for space applications) that are being developed are:</p> <ul style="list-style-type: none">➤ HECTOR, our smart rotative actuator that provides a simple, unique and efficient solution for rotation in space mechanisms.➤ The Hinge is used for a smooth deployment of antennas or booms.
---	--	---

MAJOR SPACE PROJECTS & REFERENCES

- Patents: process for producing a monocrystalline copper-based alloy
- R&T References with CNES:
 - ✓ R&T R-S18/ TG2-0002-008: Increase of the diameter of AMF HT bars
 - ✓ R-S16/TG-0002-008: DEVELOPMENT OF A HIGH TEMPERATURE SMA-BASED MECHANISM
 - ✓ R-S18/TG2-0002-136 and R-S19/TG2-0002-136: Study of heating systems for AMF components
- European Commission (EIC accelerator HORIZON2020 and CLEAN SKY2)
- Development projects with ESA, such as the 4D printing
- POC CNES dedicated to the qualification of Triggy actuators.
- Developments and projects with Airbus, DGA, and other organisms
- ISO: Nimesis has recently recruited a quality engineer to obtain the EN9100 quality standard.

POINT OF CONTACT

ADDRESS 4 rue des artisans - Frontigny
57245 Mécleuves
FRANCE

WEBSITE www.nimesis.com

PHONE +33 (0)3 87 74 26 87

POINT-OF-CONTACT: Heiko ZSCHIEDRICH, Technical Sales Engineer
h.zschiedrich@nimesis.com, +33 (0)7 88 44 90 41

TURNOVER 636 439 €

WORK FORCE 18 employees

SPACE TURNOVER 439 143 €

SPACE WORK FORCE 10 employees

Orbital systems
 Satellites
 Balloons
 Transversal competencies



NOVELTIS is a French private company that was created in 1998.

We perform innovative scientific engineering studies and implement customized end-user solutions in the fields of Space, the Environment and Sustainable Development.

Our engineers and scientists develop high-tech solutions that involve top-level skills in environmental and physical sciences, in areas covering atmosphere, oceans, and land surfaces.

COMPETENCIES & CAPABILITIES

NOVELTIS teams have extensive expertise in multi-source data processing, environmental modelling, big data, cloud computing, Web-GIS and operational decision support systems. Our company supplies end-to-end services to governmental bodies and industries.

NOVELTIS helps also the space agencies and industry design tomorrow's space missions, and promotes the use and exploitation of current missions. NOVELTIS focuses its activities on innovation, in close relations with international research laboratories.

NOVELTIS is certified to the ISO 9001 standards and has been granted "Confidential-Defense" status by the French Defense Ministry.



NOVELTIS

PRODUCTS & SERVICES

NOVELTIS offers a multitude of services and products to meet several environmental, societal and security needs. Below are some examples of these services and products:

- TechForFire is an innovative operational service for supporting tactical firefighting. This service provides real-time information concerning the current situation of the fire theatre based on satellite and aerial monitoring, as well as the risk forecasts for the coming hours thanks to advanced weather and fire modelling capacities.
- WINEO offers a full blown list of vineyard characterization and management services based on fine-scale mapping.
- MetOcean and Current EO are operational services providing a large set of innovative and reliable indicators for sea state, 3D current, weather Met Ocean and risk monitoring and forecasting.
- Atlases and advanced forecasting services for Renewable Energies (solar, wind, marine energies and biomass).

MAJOR SPACE PROJECTS & REFERENCES

NOVELTIS' range of projects in Space includes:

- Preliminary studies of new mission concepts;
- Development and exploitation of end-to-end simulators;
- Specification and analysis of the performance of observation instruments and space missions;
- Design and development of geophysical products;
- Validation of observation products and mission calibration;
- User support for the uptake of space based products.

NOVELTIS is involved in various Earth Observation missions and programs: IASI, IASI- NG, MTG, EPS-SG, IRASS, Sentinel 1 to 6, Copernicus, JASON, MERIS, GRACE, GOSAT, Microcarb, SWOT, Altika, SPECTRA, HypXim, Sentinel-NG, etc.

POINT OF CONTACT

ADDRESS 153, rue du Lac
31670 Labège - France

WEBSITE www.noveltis.com

PHONE +33 (0)5 62 88 11 11

POINT-OF-CONTACT contact@noveltis.fr

TURNOVER > M€4

WORK FORCE 40 PhD and Engineers

SPACE TURNOVER 75%

SPACE WORK FORCE 75%

Orbital systems
 Launchers
 Ground segments
 Transversal competencies



Numerisat is an ISP specialized in satellite broadband and narrow band connectivity and data communication thanks to 4G and 5G networks.

We operate BtoC and BtoB services in Europe and some African countries.

Numerisat is partner of Agence Nationale de Cohesion Numerique des Territoires (ANCT) and located in Le Bourget du Lac (73370)

COMPETENCIES & CAPABILITIES

Numerisat is specialized in Satellite data communication, IOT, and development of products for E-Health, link aggregation and events.

We design products and deliver them as plug and play packages including full operational satellite links all over the world.



NUMERISAT

PRODUCTS & SERVICES

- Satellite Kits for GEO and LEO Broadband and Narrowband Communication
- Auto-pointing antennas
- 4G and 5G Routeurs
- Backhaul technologies
- Aggregation technologies – Boîte AGREG

MAJOR SPACE PROJECTS & REFERENCES

- Satellite connections in white area zones
- Satellite and 4G connectivity for Events and disasters recoveries
- Satellite and 4G connectivity for Renewal energy fields monitoring
- Telemedecine solutions using satellite connectivity

Our products are marketed thanks to the following brands: OuiSAT – Oui4G – OuiEvents – OuiTelemedical

As part of our more than 1000 references we have: Thales, FFCAM, ESA, Lyon Airport, Videlio, French Ministry of Defense, US Army.

POINT OF CONTACT

ADDRESS 48 Avenue d Lac du Bourget
73370 Le Bourget du Lac - France

WEBSITE www.numerisat.fr

PHONE +33 (0)972 588 512

POINT-OF-CONTACT : Patrick Rousset – Directeur Général
Patrick.rousset@numerisat.fr - 22 6 71 80 49 66

TURNOVER 0.9 M€

WORK FORCE 10 employees

SPACE TURNOVER 0.5 M€

SPACE WORK FORCE 5 employees

Orbital systems
 Launchers
 Satellites
 Transversal competencies



With over 20 years of experience delivering proven thermal insulation solutions for technically challenging industries, Web Industries and its subsidiary OMEGA SYSTEMES is a leading converter of composite materials and outsourcing manufacturing services designed to simplify the production of current programs and to prepare projects of tomorrow for the aerospace industry.

Our expertise in the entire value chain with facilities in Europe & USA support the world's largest aerospace programs ensuring proximity, responsiveness and enables our customers to innovate quickly and on a large scale.

COMPETENCIES & CAPABILITIES

Comprehensive range of solutions to take over projects from design to the launch pad with:

- **Conversion and assembly of all types of materials** (including gold & black Kapton), carbon fiber, tapes, adhesives
- **All processes:** ply-cutting, CNC laser, sewing, gluing, Velcro®, edge seal-out, festooning, layering, grommets, snaps, grounding straps and more.
- **Assembly, finishing, and kitting.** Delivery to the launch pad.
- Smart **co-sourcing and supply-chain management** for better cost-control and availability of critical components



OMEGA SYSTEMES

PRODUCTS & SERVICES

Precision design conversion & precision converting of 3D models into flat patterns for thermal insulation blankets that are individually tailored to fit the complex geometries of customer hardware - custom fabrication for any size and shape:

- CAD/CREO automation and experience converting **2D to 3D designs**
- Uncompromising **QC & testing (TRL9, NFL-0015, AS/EN 9100D, ISO 9001, EN 9120 : 2018, ISO 14001, etc.)**

Automated cutting systems to faster integration and faster development of all types of materials and products, including: MLI, multi-insulation blankets, MMOD blankets, ply cutting and kitting composite prepreg for capsules and rockets.

Supply Chain simplification thanks to our vendor managed inventory services from PO to delivery.

MAJOR SPACE PROJECTS & REFERENCES

Major Launch Manufacturers.

NASA

- CADMES
- SHIVER
- ACC, Advanced Composite Project
- PETI

Ariane Group

And more

POINT OF CONTACT

ADDRESS OMEGA SYSTEMES Aquitaine
Rue Cassiopée, 33160 Saint Médard en Jalles France

WEBSITE www.webindustries.com

PHONE +33 (0) 05 56 10 40 74

POINT-OF-CONTACT : Cohard Véronique, Marketing Manager
vcohard@webindustries.eu, +336 45 99 68 08

TURNOVER

WORK FORCE Web Industries - 1000 employees

SPACE TURNOVER

SPACE WORK FORCE France - 80 employees

Launchers
 Ground segments
 Transversal competencies



Founded in 2019, OPUS Aerospace is a French newspace start-up that designs, manufactures and operates launch vehicles and space systems for small satellites.

The company's aim is to make space accessible to all, inspire humanity and shape a sustainable future in the universe.

COMPETENCIES & CAPABILITIES

OPUS Aerospace develops innovative technologies thanks to the skills of its engineers. OPUS Aerospace skills:

- Propulsion
- Structure
- Avionics
- Mission analysis
- Ground segment
- Embedded Software
- Propulsion System Testing

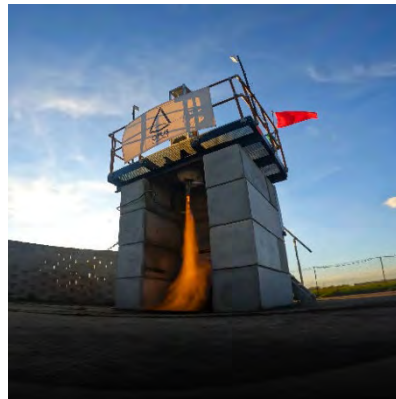

OPUS AEROSPACE

PRODUCTS & SERVICES

As a launch service provider dedicated to small satellites, our vision is to enable tailored, easy and sustainable access to space through Sterne, an orbital launcher with a payload capacity of up to 250 kg.

We provide space components designed entirely in-house such as propulsion and avionics modules to complete our in-orbit and mission management services for spacecrafts or launchers.

MAJOR SPACE PROJECTS & REFERENCES

- Mesange: a suborbital rocket to test our technologies following an R&D contract with the CNES
- Sterne: an orbital launcher dedicated to small satellites with a payload capacity of up to 250 kg
- Space Systems: propulsion and avionics modules

POINT OF CONTACT

ADDRESS 6 avenue du Centre d'Essais en Vol
91220 Brétigny-sur-Orge, France

WEBSITE www.opus-aerospace.com

PHONE +33 (0)6 67 14 43 44

POINT-OF-CONTACT : BENAMER Safouane, CEO, saf@opus-aerospace.com
+33 (0)6 67 14 43 44

WORK FORCE 21 employees

Launchers
Satellites



Pangea Aerospace develops disruptive propulsion systems to provide mobility to space and in space. We have demonstrated our expertise by developing in less than 3 years the first Methalox aerospike engine of 20kN (DemoP1) that was successfully hot fire tested in 2021. We are now developing a second aerospike engine, Arcos, that will have a thrust of 300kN. Our knowledge in chemical propulsion also extends to in-space propulsion through the development of UNYX, a 1N small sat propulsion system.

COMPETENCIES & CAPABILITIES

Our main expertise resides in propulsion systems as we have proven our competencies by developing proven propulsion subsystems thanks to efficient regenerative cooling systems that are key to aerospike engines.

We have a team of specialists in Thrust Chamber Assemblies, Turbopumps, integration of subsystems within launch vehicles, fluidic systems, test benches, and propulsion components.

In addition to our engineering offices in Barcelona and Toulouse, we also have built test facilities for our in-space propulsion system and cold-flow checks of our engine subsystems in Lleida.

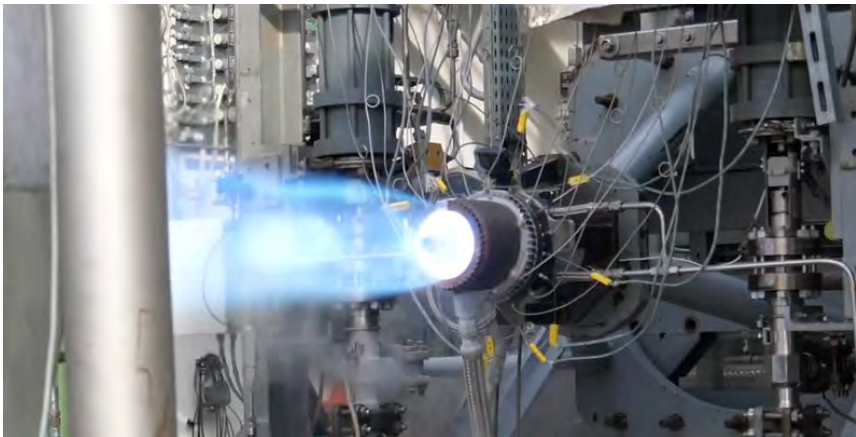

PANGEA AEROSPACE FRANCE

PRODUCTS & SERVICES

We currently have two product lines under development, ARCOS and UNYX.

Our core development is towards the conception of an aerospike rocket engine, ARCOS, which can be adapted to specific needs as it is highly scalable in terms of thrust, ranging from smaller engines of 20kN thrust to servicing the micro-launcher market with thrust between 300 and 700 kN. We expect our first engine to fly by the end of 2025.

We also can offer mobility in-space through our propulsion system U-NYX, providing chemical propulsion to help satellites or any OTV in their maneuvers.

Both products can be adapted to specific requirements, we provide services to study their integration. For our rocket engine ARCOS, we will also offer a pay-per-flight model for reusable flights in which we will manage the refurbishment of the engine once recovered.

MAJOR SPACE PROJECTS & REFERENCES

A major accomplishment for Pangea Aerospace has been the successful hot fire test of our DemoP1 aerospike engine, the first one to use Methane and liquid oxygen as propellants. Consequently, we patented our regenerative cooling system.

We have been involved in contracts with ESA and CNES to study and prove aerospike technology, most notably we just hot fire tested at the DLR's test facilities injector plates under the ITAN contract with ESA. Pangea Aerospace has also been leading a European consortium for the RRTB EC project under which reusable technologies for small launch vehicles were developed.

POINT OF CONTACT

ADDRESS 3 rue Tarfaya, B612
31400, Toulouse France

WEBSITE www.pangeaaerospace.com

PHONE +33 (0)6 26 76 75 15

POINT-OF-CONTACT : Gouzy, Marie-Laure, Country Manager,
marilaure.gouzy@pangeaaerospace.com, +33 (0)6 26 76 75 15

TURNOVER 1.4 M€

WORK FORCE 36 employees

SPACE TURNOVER 1.4 M€

SPACE WORK FORCE 36 employees

Orbital systems
Satellites
Ground segments
Transversal competencies



Parsimoni develops software solutions for satellites.

SpaceOS is a “Secure By Design” operating system, designed for efficiency and scalability to power not only current but also next generation – multi-user, multi-mission or software defined satellites. Our goal is for SpaceOS to become the “android” for satellites.

The Parsimoni Satellite As A Service marketplace is our second offer – powered by SpaceOS – to make real time satellite data accessible to all.

COMPETENCIES & CAPABILITIES

- Secure By Design , highly efficient operating system for satellites, invented and developed in Europe: the “android” of satellites
- Unikernel technology – upto 50x smaller vs. alternatives
- Memory safe programming language – block 70-80% of all cyber attacks by design
- We develop space software in Europe – and our technology is one of the best in the world



SpaceOS

PARSIMONI

PRODUCTS & SERVICES

- We work with satellite operators to replace their current software containers with SpaceOS to allow for 10-20x more software in the same storage
- We also propose SpaceOS to satellite builders: SpaceOS can be a part of a payload computer from the design stage to provide the biggest benefits in efficiency and scalability.
- The Parsimoni Satellite As A Service marketplace will benefit all users of the satellite ecosystem. Users of data will get access; developers of satellite software (AI in Space) will get a secure and standard platform (no need to rewrite the code for a different satellites – develop it once and run on any satellite) and satellite owners / operators will see an increase in revenues due to higher utilization of the capacity on board their satellites. Everybody wins!

MAJOR SPACE PROJECTS & REFERENCES

- Thales / TAS: SpaceOS POC: 20x smaller vs. Thales alternative; less memory, less process resources used
- OHB – partnering on the development of the Parsimoni Satellite As A Service Marketplace
- Airbus – winner of the 2024 Paris Space Week innovation Prize
- CNES – Recipient of the Space Ticket

POINT OF CONTACT

ADDRESS 7, Rue Leonard Da Vinci, Pau
64000 France

WEBSITE www.parsimoni.co

PHONE +33 (0)6 52 45 37 60

POINT-OF-CONTACT : Miklos Tomka, CEO, miklos@parsimoni.co
+33(0)652453760

TURNOVER 60 K€

WORK FORCE 4

SPACE TURNOVER 60 K€

SPACE WORK FORCE 4

Launchers
Satellites
Ground segments
Transversal competencies



PCB PIEZOTRONICS manufactures piezoelectric, Mems piezoresistive, capacitive sensors and instrumentation for ground & flight tests.

COMPETENCIES & CAPABILITIES

Accelerometers, pressure sensors, microphones and piezoelectric, MEMS piezoresistive sensors are used for numerous applications, such as ground testing of aircraft & defense vehicles, satellite testing, aerodynamic and aeroacoustics tests, environmental tests, pyroshock applications, aerospace flight tests,

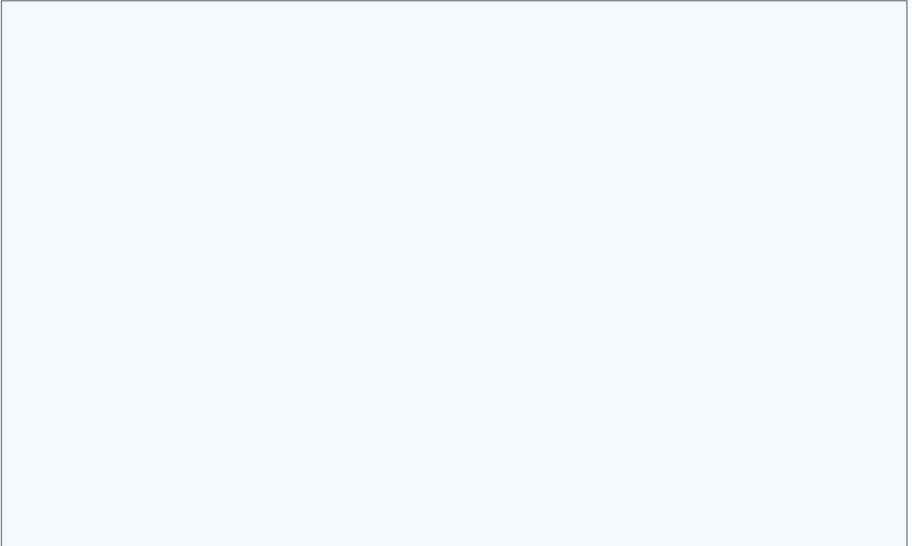

MAJOR SPACE PROJECTS & REFERENCES

AIRBUS EADS DGA SAFRAN

POINT OF CONTACT

ADDRESS Immeuble Discovery – Bat A – Parc Technologique – Route de l’Orme – 91190 SAINT AUBIN France

WEBSITE www.pcbpiezotronics.fr

PHONE +33 (0)1 69 33 19 60

POINT-OF-CONTACT : BRIQUET Philippe, Chef de Marche A&D
pbriquet@pcbpiezotronics.fr, +33 (0)6 26 29 46 29

TURNOVER 11 M€

WORK FORCE 15

SPACE TURNOVER 6 M€

SPACE WORK FORCE 2

Satellites
Transversal competencies

PHOTONIS

Photonis is a global manufacturer of electro-optic solutions used in the detection of ions, electrons, and photons. We develop, produce, and market innovative sensors for detecting and amplifying very low levels of light, charged particles, and radiation. Our products are used in a wide range of applications from night vision devices to analytical instruments, and even in nuclear reactors and warships. We manufacture custom detectors designed to meet your specified performance and sensitivity criteria.

COMPETENCIES & CAPABILITIES

- We innovate and engineer quality components for integration into a variety of applications such as night vision optics, digital cameras, mass spectrometry, physics research, space exploration, nuclear applications and many others.
- The R&D staff is located in factories and laboratories across the globe. We employ engineers, innovation experts, physicists, chemists and other specialists to challenge the accepted beliefs of physics, optics and electronics to advance ion, electron and photon detection technologies. These technologies further advance to bringing new and innovative products to market.



DISCOVER THE SECRETS OF THE UNIVERSE

Photonis

PRODUCTS & SERVICES

- **Space Exploration Solutions:** Our products have soared into distant galaxies and have led to incredible breakthroughs space research.
- **Nuclear Instrumentation Solutions:** Through collaborations with CEA and other agencies, we have developed a wide range of standard and custom products to monitor fission reactions and spent fuel.
- **Analytical Instrument Detectors:** We offer greater sensitivity and longer lifetime to increase the performance of your instrument.
- **Photonic Detectors:** Our award-winning products are used in various fields - from medical diagnostics to high energy particle physics research
- **Night Vision Tubes and Systems:** We design and manufacture state-of-the-art image intensifier tubes for military, space and commercial applications.
- **Digital Vision Solutions:** We offer award-winning innovations in low light CMOS technologies. From sensors to systems, we provide a wide range of options for single technology day-through-night images.

MAJOR SPACE PROJECTS & REFERENCES

Photonis has been partnering with the world's leading space agencies for decades in order to provide the highest quality detectors. Photonis is on board of: •Parker Solar Probe •GOES-S •GOES-R Orbiter •Juno spacecraft •New Horizons •ASTRO-H •MAVEN •Rosetta •Laser Megajoule •Rover module •Hubble Telescope

References:



POINT OF CONTACT

ADDRESS Avenue Roger Roncier, 19100 Brive-la-Gaillarde France

WEBSITE www.photonis.com

PHONE +33 (0)5 55 86 37 00

POINT-OF-CONTACT : Emilie Kernen - R&D Group Manager and Manager
Scientific Detectors Science@photonis.com

TURNOVER 80% Defence, 20% Science

WORK FORCE 1.000 Employees worldwide, Multi-award winning technology,
80+ Years of experience in optical imaging and particle detection

SPACE WORK FORCE 6% Annual revenue re-invested in R&D and
Innovation, 100+ Patents for Proven Technology

Transversal competencies



Pixstart delivers insights without precedence from satellite imagery, bringing geostrategic and geomarketing services to organizations. Our methodology leverages scientific satellites & Artificial Intelligence algorithms to create valuable services.

COMPETENCIES & CAPABILITIES

Pixstart developed its own operational platform using all the last disruptive innovation: bigdata, cloud computing, Machine Learning, Deep Learning ...

It allows Pixstart to process automatically a huge volume of data (imagine a scan of all Earth every 5 days...we use several satellites with this capability).

All our process lines mix data from satellite observation with other kinds of geographical data like INSEE data, governmental data or your own private data.

Our system of machine learning & artificial intelligence enables continuous improvement of our algorithms. This provides more and more valuable KPI for public or private strategic decision maker



PIXSTART

PRODUCTS & SERVICES

We have generated an application portfolio dedicated to each activity sector like:

- Buildspot to monitor construction sites
- Urbanwatch to analyse the urban expansion and composition
- Airwatch to monitor the aerosols
- Waterwatch to monitor water quality
- Poolspot to detect and contact swimming pool owners
- Farmwatch to monitor farm production
- Woodwatch dedicated to the forestry sector
- Sitespot to monitor human activities like car parking

To answer your expectation, it's possible to mix different applications or create a specific one based on our algorithm portfolio.

More information on <https://www.pixstart.io/our-services/>

MAJOR SPACE PROJECTS & REFERENCES

Poolspot application using S2 data funded by ESA / CNES :
<https://business.esa.int/projects/poolspot>

Buildspot application using S2 data funded by ESA / CNES

QuantEO : <https://eo4society.esa.int/projects/new-ia-innovative-service-for-sentinel-data/>

Securitywatch boarder monitoring using Sentinel2 data with WCO - the World Customs Organization (<http://www.wcoomd.org/>)

Diamniado Project – Senegal urban monitoring using Sentinel-2 and Pleiades Data - Funded by CNES

POINT OF CONTACT

ADDRESS 244 routes de Seysses – Bat. 3 – 31100 Toulouse - France

WEBSITE www.pixstart.io

PHONE +33 (0)6 61 57 32 07

POINT-OF-CONTACT : Richard Barré, CEO

richard.barre@pixstart.io, +33(0)671131736

TURNOVER 220 K€

WORK FORCE 6 employees

SPACE TURNOVER 220 K€

SPACE WORK FORCE 6 employees

Transversal competencies



Established in 1999, PLUG IN is a reference in designing and manufacturing **original hermetic feedthroughs**.

We can offer any type of standard flanges (**ISO KF, K, F or CF and even special**) having any type of connector sealed.

COMPETENCIES & CAPABILITIES

- Design and manufacturing of hermetic feedthroughs using epoxy compound sealing.
- Sealing of almost any type of components (connectors as DSub, MicroD, RF, Optical, Circular, Network & Video, and Wires, Thermocouples, even PCB).
- Quantities from 1 to several dozens.
- Design & manufacturing of specific connectors, vacuum components and small vacuum chambers.
- Technical assistance



PLUG IN

PRODUCTS & SERVICES

Established in 1999, PLUG IN is nowadays considered as a reference in terms of design and manufacturing of HERMETIC FEEDTHROUGHS dedicated to environmental testing under vacuum, and more generally everywhere there are two different environments (liquids or gases). Our concept is based on an original space qualified epoxy compound offering reactivity, reliability, flexibility and high hermeticity. Then we can seal almost any type of connector (signal, power, high voltage, RF, networks, etc.) or cable (high voltage, power, thermocouples, etc.)

MAJOR SPACE PROJECTS & REFERENCES

Environmental test labs of CNES, TAS, AIRBUS D & S, ESA, ESTEC, OHB, IABG, RUAG, CRISA, DLR, NLR, ISRO, KARI, JAXA, IAI-MBT, Blue Origin, etc.

POINT OF CONTACT

ADDRESS 5 rue du Corps Franc du Sidobre
81210 Roquecourbe, France

WEBSITE www.plugin-vacuum.com

PHONE +33 (0)5 63 82 50 60

POINT-OF-CONTACT : LIONNET, Agnes, Sales & Quality Manager
quality@plugin.fr

TURNOVER 1.3 M€

WORK FORCE 6 employees

SPACE TURNOVER 1.1 M€

SPACE WORK FORCE 6 employees

Ground segments
Transversal competencies



POSITHÔT – la Manufacture d’Antimatière – offers services and equipment’s for non-destructive defects measurement with a nanometer scale resolution. Based on positron annihilation spectroscopy, this nondestructive analysis technique is efficient on any kind of materials, metals, ceramics, polymers, semi-conductors. POSITHÔT has a unique technology of positron production by a non-radioactive way.

COMPETENCIES & CAPABILITIES

POSITHÔT has a unique technology of positron production by a non-radioactive way. Using it POSITHÔT develops services in defect characterization, and equipment for materials development, surface analysis and non-destructive testing. The ultimate resolution of these systems is in the range of the transmission electron microscopy technique, but with a non-destructive technique. It gives information of the dislocation and vacancy density, prior to the appearance of cracks and vacancy clusters.

The positron spectroscopy is effective on any kind of materials, metals, ceramics, semiconductors, polymers, composites, thin films and layered structures. Analysis has to be adapted to each material.

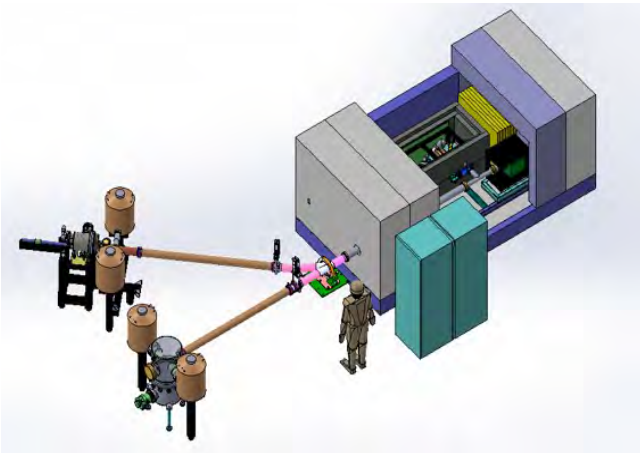

POSITHÔT

PRODUCTS & SERVICES

POSITHÔT offers nondestructive testing equipment's based on nonradioactive positron generators, and their installation on the customers premises. These equipment's are designed following the customer specification and adapted to the requirement of the part to be analyzed. The equipment definition is made after R&D phases to validate the effectivity of the technique to fulfill the key issues of the specification.

In order to validate the testing sequences and measurement procedures, POSITHÔT also offers services in defect and defect density analysis. Eventually long-term contracts for maintenance repair and overhaul activities can be considered.

MAJOR SPACE PROJECTS & REFERENCES

Ongoing studies done by POSITHÔT covers the following fields:

- Early-stage damage appearing in fatigue in metallic structures. This is done under the CNES challenge R&D "launchers for the future" contract; It highlighted the initial damage appearing in the first 50 nanometers near the surface of the material for a solicitation corresponding to half of the mechanical strength. Similar works are carried out for aircraft parts and materials;
- Identification of ageing consequences in solid propellants for rocket engines.

POINT OF CONTACT

ADDRESS 31 rue Achille Garnon
92 330 Sceaux, France

WEBSITE www.posithot.com

PHONE +33 (0)6 52 02 65 60

POINT-OF-CONTACT : REY Jean-Michel, CEO, jean-michel.rey@posithot.com

TURNOVER

WORK FORCE 5 employees

SPACE TURNOVER

SPACE WORK FORCE 5 employees

Transversal competencies

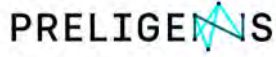

Preligens (ex-Earthcube) develops pioneering technology to enhance operational decision-making to build a safer world. Its artificial intelligence solutions are based on an automated analysis of geospatial intelligence (GEOINT) workflows. Powering state-of-the-art Machine Learning and Computer Vision, Preligens aggregates information from multi-intelligence sources (Multi-INT) to provide its Defence and Intelligence customers with strategic knowledge regarding mission critical areas of interest ensuring a more insightful operating picture.

COMPETENCIES & CAPABILITIES

Preligens' historical expertise lies in the automated analysis of optical satellite images. Its proprietary powerful AI algorithms run on the latter to detect, classify and identify objects of military interest (see illustration below).

Later on, Preligens teams have started working on other types of geospatial data, adding up other kinds of satellite imagery, such as SAR, Night Light, or SWIR, but also data coming from ELINT sensors such as AIS or ADS-B, or Open Source data coming from social network. All metadata associated to this geospatial information is hence used to deepen the analysis, continuously train AI algorithms to reach better performance, and eventually to structure, correlate and fuse information coming from all sensors for a comprehensive analysis.

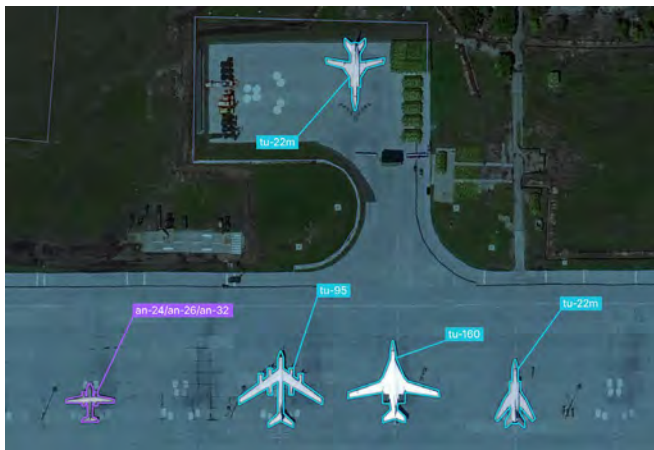

Aircraft

<input checked="" type="checkbox"/> All	113
<input checked="" type="checkbox"/> Bomber	23
<input checked="" type="checkbox"/> Civilian	15
<input checked="" type="checkbox"/> Combat	39
<input checked="" type="checkbox"/> Special	0
<input checked="" type="checkbox"/> Transport	33
<input checked="" type="checkbox"/> Helicopter	3

PRELIGENS
 Détection automatique des classes et modèles d'aéronefs grâce à l'intelligence artificielle

PRELIGENS

PRODUCTS & SERVICES

Preligens' pioneering AI solutions are divided into two lines of products.

The IMINT product, the Strategic Site Monitoring application software, is dedicated to monitoring sites of military interest VHR satellite imagery. It provides its users with dashboard-centric alerts to unusual patterns of life along with the drill-down capability to assess the full image context. Aggregating multiple artificial intelligence detection algorithms, the platform delivers automatic feature extraction of military activity on those sites and the corresponding alert generation.

Additionally, Preligens Multi-INT tool monitors theaters of operations at scale. It leverages multi-sensor data, coming from all intelligence disciplines (IMINT, ELINT, OSINT), to provide its users with comprehensive and synthetic dashboards, to highlight key nodes and spot vulnerabilities. Aggregating information gathered from multiple sources, it enables an automated and systematic feature extraction to analyze trends and recognize patterns of life. An automated alert system permits its end-users to aggregate and correlate abnormal activities to identify weak signals and anticipate the appropriate course of action.

MAJOR SPACE PROJECTS & REFERENCES

Preligens, formerly Earthcube, was involved in ESA Business Applications program in 2018.

Additionally, since its solutions are providers agnostic, Preligens works with multiple satellite image providers, such as Airbus, with whom a joint site monitoring solution was developed — OneAtlas Defense Site Monitoring, but also Maxar, Planet, ESA, ...

More recently, with the launch of Pleiades Neo by Airbus, Preligens belongs to the group of early adopters to test its analytics capabilities on Airbus' new constellation's images.

POINT OF CONTACT

ADDRESS 31 cité d'Antin
75009 Paris, France

WEBSITE www.preligens.com

POINT-OF-CONTACT Juglard Nathan, Key Account Manager AAE
Nathan.juglard@preligens.com

WORK FORCE 150 employees

Transversal competencies

Procureezy

We are a Paris based company dedicated to simplifying and optimizing procurement for space companies. Our platform offers a seamless sourcing experience, helping engineers and procurement teams navigate the complexities of hardware component and supplier selection.

COMPETENCIES & CAPABILITIES

Our expertise lies in understanding the unique challenges of space hardware procurement and addressing them through AI-powered solutions. Our platform is designed to enhance supply chain transparency, streamline sourcing processes, and support critical decision-making for complex engineering needs in the space sector.

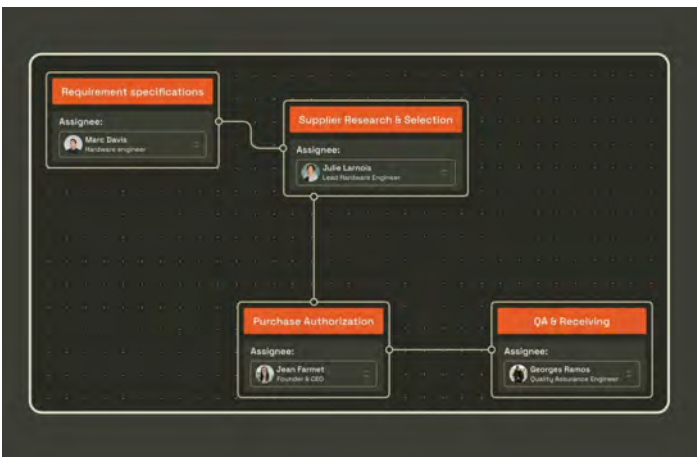

PROCUREEZY

PRODUCTS & SERVICES

Our primary offering is an AI-driven procurement platform for space hardware.

The platform includes:

- **Procurement tools:** procurement workflows, purchase requests related features and collaborative tools.
- **Sourcing engine:** an intelligent copilot that assists engineers in identifying suitable suppliers, and provides comparative analyses for components.
- **Internal supplier database:** Additionally, our integrated supplier database enables engineers to access a curated network of space-specific suppliers.

MAJOR SPACE PROJECTS & REFERENCES

We have partnerships agreements with French and European suppliers: Cedrat Technologies, Comat, Exotrail, Spacemanic, Spacrace, Arcsec...

POINT OF CONTACT

ADDRESS 5 avenue de l'Opéra
75001 PARIS France

WEBSITE www.procureezy.com

PHONE +33 (0)7 44 79 74 79

POINT-OF-CONTACT : Grenet, Cindy,CEO
cindy@procureezy.com

TURNOVER NC

WORK FORCE 2 cofounders

Orbital systems
 Ground segments
 Satellites
 Transversal competencies



Prométhée Earth Intelligence is a French NewSpace operator of nanosatellite constellations for Earth observation, founded in January 2020.

The company responds to the challenges of sustainable development and crisis management by providing environmental and strategic Intelligence Services on the one hand, and Sovereignty Space infrastructure on the other.

COMPETENCIES & CAPABILITIES

- Design of space mission constellation with advanced capabilities, including high revisit rates, inter-constellation connectivity, embedded AI, ...
- Operation of our own constellation
- Prométhée Earth Observation' satellite data delivery and advanced products for civil and defense applications
- Services' advanced capabilities: gather and analyse information through our proprietary multi-source aggregation platform (EOP).



Earth Intelligence as a Service



Space Sovereignty as a Service



PROMÉTHÉE Earth Intelligence

PRODUCTS & SERVICES

Earth Intelligence as a Service

thanks to a proprietary Earth Observation Platform (EOP), allowing:

- access to optical imagery from Prométhée Earth Intelligence' satellites: tasking and/or archive.
- access to open source imagery and others geo-localized data
- value added services : data analytics, geospatial intelligence, ...

Space Sovereignty as a Service:

An end-to-end and customized solution to answer B2G customer needs, including:

- Satellite constellation design
- Ground Segment to operate the constellation
- Image Processing capacities
- Digital platform to exploit imagery data and associated services

MAJOR SPACE PROJECTS & REFERENCES

▪ SAPHIR Telescope

2023 : awarded under France2030. Project in consortium led by Bertin technology, with U-Space and Laboratory of Astrophysics of Marseille.

▪ Copernicus Contributing Mission Cat-1

2023 : awarded by ESA as one of the New Space satellite data suppliers joining the Copernicus programme as 'Contributing Missions'.

▪ JAPETUS

2022 : grant received by CNES under "France Relance Volet D" to build the first demonstrator satellite to prepare the constellation.

▪ Geospatial Data Access

2022 : awarded by MAE-DCSD for services access through Prométhée Earth Intelligence' digital platform (EOP)

POINT OF CONTACT

ADDRESS 1165 av JRG Gautier de la Lauzière.13290 Aix-en-Provence, France

WEBSITE <https://www.promethee.earth/en/>

PHONE +33 (0) 6 08 49 84 37

POINT-OF-CONTACT : Florence Bonetti

Chief Communication & Public Affairs Officer

f.bonetti@promethee.earth

TURNOVER

WORK FORCE 50 employees

SPACE TURNOVER

SPACE WORK FORCE 50 employees

Launchers
 Orbital systems
 Satellites
 Ground segments
 Balloons
 Transversal competencies



Pyroalliance, subsidiary of ArianeGroup, develops and manufactures a broad range of mechanical and energetic solutions for defence, space and industrial markets where safety, performance and reliability are key.

Our energetic systems typically cover the following functions: motor and rocket ignition, transmission, stage separation, flight termination, mechanical actuation...

COMPETENCIES & CAPABILITIES

Pyroalliance has 50 years' experience in designing, developing, producing and marketing mechanical and energetic solutions for missiles, launchers, satellites and interplanetary probes.

Our high added-value systems, our know-how and our expertise have made Pyroalliance one of the selected suppliers of the major prime contractors and space agencies (Airbus Defense and Space, ArianeGroup, Arianespace, AVIO, CNES, Dassault Aviation, ELV, ESA, MBDA, Space Systems Loral, Thales Alenia Space...).

Pyroalliance quality and environment management systems are ISO 9001/14001 and EN 9100 certified.



PYROALLIANCE

PRODUCTS & SERVICES

Pyroalliance supplies products which are qualified to the highest space sector standards and which are not subject to ITAR regulations (International Traffic in Arms Regulations). Our products for space applications include: igniters/gas generators, shockwave initiators, arm and distribution boxes, detonating transmission lines, separation rings and sectors, flight termination charges, low-shock release mechanisms, cutters, thrusters.

Based on technological bricks already tested and qualified on different applications, Pyroalliance has the engineering capability to design a complete pyrotechnic chain and offer an end-to-end solution combining in house and procured equipment that will fulfil the functional need expressed by the customer.

Pyroalliance will act as a one-stop-shop, managing all interfaces within the considered chain.

The production skill sets of Pyroalliance rely on a high level of qualification of operators and technicians thanks to several years of on-the-job training, particularly in the case of assembly skills.

MAJOR SPACE PROJECTS & REFERENCES

Pyroalliance has made, and continues to make, a significant contribution to Europe's ARIANE and VEGA launcher programs.

Pyroalliance has contributed to the success of the GLOBALSTAR 1 & 2, O3b (Other 3 Billion), DMC3 and more recently on mega-constellations by ensuring hold down and release of satellites from the dispensers.

Pyroalliance also has a 100% track record in supplying systems necessary for in-orbit deployment of solar panels and screens, antenna reflectors and masts on multiple satellite platforms such as: Amazonas, Amos & Opsat 3000, Cassini / Huygens, Eurostar, ESA CUST and Spacebus.

POINT OF CONTACT

ADDRESS: 139 route de Verneuil, 78 132 Les Mureaux (Head quarter)

WEBSITE: www.pyroalliance.com

PHONE: +33 (0)1 34 92 44 44

POINT-OF-CONTACT: Degryse François

Head of Strategy and Business Development

francois.degryse@pyroalliance.com, +33 (0)6 29 48 11 38

TURNOVER: 38 Millions € in 2019

WORK FORCE: 220 collaborators

SPACE TURNOVER: undisclosed

SPACE WORK FORCE undisclosed

Transversal competencies

Launchers

Satellites

Orbital systems



PYTHEAS Technology is an expert in design and manufacturing of innovative piezoelectric devices. Its field of competence mainly covers 3 types of applications: Vibration control (dampers/isolators, energy harvesting, structural health monitoring); Ultrasonic devices (non-destructive testing, flowmeter); Actuators (piezo-valves, piezo-pump)

COMPETENCIES & CAPABILITIES

- Piezoelectric vibration dampers and isolators (semi-passive, frequency tunable)
- Embedded structural health monitoring, energy harvesting and non-destructive evaluation.
- Piezoelectric sensors (flowmeter, ultrasound probes)
- Piezoelectric actuators (positioners, valves, pump, de-icing system)

Piezoelectric high-speed valve



Vibration absorber

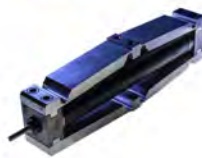

PYTHEAS TECHNOLOGY

PRODUCTS & SERVICES

PYTHEAS Technology offers piezoelectric devices for:

- Vibration damping and isolation. Proprietary technologies are semi-passive and frequency tunable.
- Energy harvesting and self-supplied sensors
- Structural health monitoring and embedded non-destructive evaluation
- Ultrasonic flowmeter and ultrasound probe
- Piezo-valves and piezo-pump

MAJOR SPACE PROJECTS & REFERENCES

Challenge R&D CNES laureate (2020): Embedded non-destructive evaluation system for future reusable satellite launchers.

PYTHEAS Technology develops an embedded sensor network using ultrasonic lamb waves for detection, localization, and identification of defects.

Main customers in space industry:

- CNES
- LIEBHERR Aerospace
- IXBLUE
- ArianeGroup

POINT OF CONTACT

ADDRESS 100 impasse des houillères 13590 Meyreuil France

WEBSITE <http://pytheas-technology.com/>

PHONE +33 (0) 6 76 29 84 64

POINT-OF-CONTACT MOSCA Frédéric, CEO

frederic.mosca@pytheas-technology.com, +33 (0) 6 76 29 84 64

TURNOVER 1 M€

WORK FORCE 20 employees

SPACE TURNOVER 0.2 M€

SPACE WORK FORCE 8 employees

Launchers
Satellites
Balloons
Transversal competencies



R.Tech, founded in 2001, is an SME specializing in engineering and software development services.

The combination of a team of PhD's, engineers and software developers assures that the software developers are aware of the physics that needs to be implemented, respecting the strict software quality requirements.

COMPETENCIES & CAPABILITIES

R.Tech performs numerical simulations of aerodynamics, thermal and mechanics, with a specialty in re-entry into the atmosphere of the Earth and other planets. We develop in house numerical-analysis software (CFD, heat transfer, fluid-structure interaction ...) and own a computer cluster with about 700 cores.

We develop both internal software as well as on demand software, as an example, we are also the main partner of the CNES for the development of tools for the spacecraft demise tools (PAMPERO/DEBRISK).



R.TECH

PRODUCTS & SERVICES

R.Tech provides aerothermodynamics support for all flow regimes, with specialization in the atmospheric reentry.

A spectrum of tools ranging from high fidelity aerothermodynamics simulations, to lower fidelity but fast spacecraft breakup tools such as DEBRISK and PAMPERO are operated.

On demand software development and software maintenance are provided, mainly for scientific applications, but also for industrial applications.

R.Tech is the exclusive distributor of the GridPro and Helyx software in France, and the exclusive partner of CNES for the operation of the PAMPERO spacecraft demise prediction tools.

MAJOR SPACE PROJECTS & REFERENCES

The engineering department of R.Tech has been involved providing aerothermodynamics support for a large number of European and French projects, such as the Intermediate experimental Vehicle IXV, ExoMars, Ariane 6 Launch infrastructure, Stratobus.

The software development department has been providing services for several space projects, such as the development of the DEBRISK and PAMPERO software, visualization software and signal processing for the SEIS mission, mission control centers for balloon operations, and launch site software support.

Finally, the computer vision department installed several non-intrusive quality control systems in the factories where the stratospheric balloons are produced for CNES.

POINT OF CONTACT

ADDRESS Delta Sud Parc Technologique - 10, impasse Jean Mermoz
09340 VERNIOLLE France

Website www.rtech.fr

Phone +33 (0)9 72 52 87 50

POINT-OF-CONTACT Martin SPEL - Manager

TURNOVER 1000 k€

WORK FORCE 12

TURNOVER SPACE 800k€

SPACE WORK FORCE 9

Orbital systems
Satellites
Ground segments
Transversal competencies



Radiall is an interconnect component specialist, focused on 3 core technologies: Radio Frequency, Fiber Optics and Multipin Packaging. The company operates on various markets including space industry.

With involvement in more than 300 satellite programs since 1974, its space solutions have established a strong reputation.

COMPETENCIES & CAPABILITIES

- Designing and modeling space components with specific tools: ANSYS, Solidworks, CST Microwave Studio, COSMOS Works, HFSS.
- Manufacturing of high performance space qualified products within 600m2 ISO 7 and ISO 8 clean rooms.
- In-house test on following equipments: VNA, Thermal chamber with nitrogen injection, Thermal vacuum chambers, ATE for electrical switch parameters, X-ray equipment, Multipaction and power handling test benches, Vibration shakers, Half sine shock machine, Reverberation chamber for EMC measurements.



RADIALL

PRODUCTS & SERVICES

Radiall manufactures a complete range of space qualified products with a frequency range up to Q-band.

Its expertise on space market permits Radiall to design RF connectors, RF cable assemblies, Microwave passive components, Microwave switches and Optical interconnect systems that answer to the high quality requirements of these dedicated applications.

Radiall also assists customers in the definition of their equipment, advising the configuration of product that could best fit their need.

MAJOR SPACE PROJECTS & REFERENCES

GEO space programs: YAMAL 401/402/601, Hispasat AG1, Telkom-3S, Syracuse 3C, Eutelsat: E21B, E5WB, E8WB, E172B & Konnect, SES-10, SES-14, SGDC-1, Turksat 4B, 5A & 6A, Arabsat 6B...

Space constellations: Globalstar, O3B, Iridium Next.

Scientific, Observation & Geo-positioning space programs: Quasi zenith, Galileo, Meteosat, EXOMARS, ROSETTA, COSMO.

POINT OF CONTACT

ADDRESS 25 Rue Madeleine Vionnet, 93300 Aubervilliers, France

WEBSITE www.radiall.com

PHONE +33 (0) 1 49 35 35 35

POINT-OF-CONTACT : Olivier Berenfeld, Space market manager

olivier.berenfeld@radiall.com, +33 (0) 4 74 94 90 32

TURNOVER 305 M€ in 2020

WORK FORCE 2900 employees

SPACE TURNOVER 20 to 25 M€

SPACE WORK FORCE Not available

- Orbital systems
- Launchers
- Satellites
- Ground segments
- Transversal competencies



Rakon is a global high technology company that designs and manufactures world leading frequency control solutions for the Telecommunications, the Positioning, Internet of Things and High-Reliability (Space & Defense) markets.

All its Space related activities are located in France and are focusing on the whole Space market (traditional and NewSpace).

Our competencies and capabilities make us a supplier of choice in the Frequency Control Products domain.

COMPETENCIES & CAPABILITIES

Our different core competences let us design and manufacture for the traditional GEO and the New Space markets, highly stable, low phase noise, low power consumption and highly integrated solutions.

Rakon's product range comprises of large equipment like complex and high performance Frequency Generation Units or state of the art Ultra Stable Oscillators through to low cost oscillators and timing modules like synthesizers suitable to LEO missions.

Moreover, Rakon components like resonators are being on the ESCC QPL and Crystal MEMS (XMEMS©) are also available in our portfolio.



Future Technology Focus



RAKON

PRODUCTS & SERVICES

With its large product portfolio, Rakon is offering different lines of products addressing the needs of the whole Space market, the traditional one with its long missions and highest reliability and the NewSpace one with its shorter missions and unbeatable cost/reliability ratio:

- **Frequency Generation Units series** with its Master Reference Oscillators and Master Local Oscillators
- **Phase-locked oscillator series** with its very integrated and low noise variants
- **USO series** with its entry level or state of the art Ultra Stable Oscillators
- **Low Power & Low Noise oscillator series**
- **Xtal resonator & clock drivers series** with its ESCC QPL products and XMEMS©

MAJOR SPACE PROJECTS & REFERENCES



POINT OF CONTACT

ADDRESS 2 rue Robert Keller
10150 Pont Sainte Marie France

WEBSITE www.rakon.com

PHONE +33 (0) 6 33 62 24 93

POINT-OF-CONTACT : Elzear, Laurent, Business Development Manager
laurent.elzear@rakon.com, +33 (0) 6 33 62 24 93

TURNOVER 70 M€

WORK FORCE 990

SPACE TURNOVER 15 M€

SPACE WORK FORCE 70

Orbital systems
 Launchers
 Transversal competencies



REAL DREAM SAS has a recognized experience in design and innovation: creation of concepts, sketches, illustrations, videos with animations. As a transversal competency, it delivers associated digital files, notably in the space and aerospace field for orbital systems, launchers, satellites, ground segments, space logistics and new segments as cleaning and re-orbiting, ground and space representations.

COMPETENCIES & CAPABILITIES

REAL DREAM masters spatial architecture, design and interfaces with the most advanced 3D digital representation tools as well as the dialogue with space systems engineers. We are particularly trained in the phases of international tenders.

These require convincing presentations with dynamic, functional and very realistic (almost photographic) models of space systems in their terrestrial, orbital or planetary environment within a limited timeframe. In the design process, REAL DREAM brings its expertise in aesthetics and feasibility of its customers' products in order to give them a recognizable signature to each of them in order to enhance the particularities and qualities of their products.



2020 THEMIS launcher for ArianeWorks



2022 Space Van for EXOTRAIL

REAL DREAM

PRODUCTS & SERVICES

REAL DREAM created in 2018 has an HMONP architect specializing in space design and an engineer specializing in launch vehicle and satellite systems.

Our services cover from the study and the complete Design:

- Technical design, technical illustrations and modeling in extreme environments.
- Various animations of mechanical movements and deployments, rendezvous and ejections, with all kinds of propulsions, robotic arms and tools, for logistic operations.

Our supplies include:

- Illustration and artwork with ultra-high definition images.
- Spectacular videos with large environmental sets in space and planets.

MAJOR SPACE PROJECTS & REFERENCES

REAL DREAM has won 3 international space architecture competitions:

- in 2018 for an orbital station called "Solar Spore" (Favorite prize of the Rougerie France Foundation),
- in 2019 for a lunar village called "Selenia" (Jury prize of the Rougerie France Foundation),
- in 2020 for a city on Mars called "Olympia" (1st prize of the Mars City Design USA Foundation).

Since 2018 REAL DREAM has produced numerous projects for CNES, Ariane Works, Thales Alenia Space France, Exotrail, Mars city design LLC, Nubbo/Orius.

POINT OF CONTACT

ADDRESS 50 rte de BUNZAC Les RASSATS 16590 BRIE France

WEBSITE www.real-dream.fr

PHONE +33 6 50 27 82 33

POINT-OF-CONTACT : Tryuman, Sylve, CEO

sylve.tryuman@real-dream.fr +33 6 64 26 05 45

TURNOVER <1 M€

WORK FORCE 2

SPACE TURNOVER <1 M€

SPACE WORK FORCE 2

Orbital systems
 Launchers
 Satellites
 Ground segments
 Transversal competencies



RESA is a French EMS specialized since 1994 in HiRel electronic hardware manufacturing for Space, Defense, Aeronautics and Healthcare :

- Process engineering & process verification
- Electronic boards manufacturing & test
- Control units integration
- Design & manufacturing of ground systems and test stands (incl. electronic boards)

Since 2020, RESA has lead-free manufacturing capabilities.

COMPETENCIES & CAPABILITIES

RESA has 1000m² of clean rooms embedding many capabilities dedicated to space industry:

- A process engineering team
- 25 hand manufacturing operators including inspectors
- Components warehouse and traceability
- 2 Pick and place lines (Leaded and RoHS)
- 2 Wave soldering equipments (Leaded and RoHS)
- 1 Leadless parts Hot Air repair system
- Hand soldering (Leaded and RoHS)
- Coating (Pulyurethan and silicon)
- Test (Flying probes & functional test)
- 1 internal training school (RESA SCHOOL) managed by an ESA instructor

RESA

PRODUCTS & SERVICES

Relying on its more than 25 years know-how in space and HiRel industry, RESA has adapted its scope of services in order to cover a wide range of activities that are complementary to its core business: HiRel electronics manufacturing.

RESA, is able to support its customers at each step of their programs:

- Design to manufacturing
- Process verification, including monitoring systems design
- Process engineering, including tooling & fixtures design
- Manufacturing (Pick&place, hand soldering, coating, inspection)
- Integration
- Test, including test-stands design and manufacturing

Thanks to an effective network of local partners, RESA is able to enlarge its capabilities in order to fulfill customers' requirements such as mechanical parts design and manufacturing and full electronic boards design.

MAJOR SPACE PROJECTS & REFERENCES

Since its birth, RESA has contributed to many space programs, as direct supplier of AIRBUS DEFENCE & SPACE, THALES ALENIA SPACE, ARIANE GROUP, CNES, CNRS, CEA and many other companies.

RESA was involved in the following projects among many others, for civil and defense missions:

Curiosity, Herschel, Pharo, Bepi Colombo, Sentinel, Solar Orbiter, Ariane IV-V-VI, Microscope, Pleiades, Myriade, Alphabus, Euclid, Sentinel 2-5, Doris, Grace, Horizon2020, Microcarb, Myriade-Evolutions, Taranis...

POINT OF CONTACT

ADDRESS RESA , 4 avenue de la Baltique
ZAC Courtabœuf
91140 Villebon-sur-Yvette France

WEBSITE www.resa-electronique.com

PHONE +33 (0)1 60 92 33 40

POINT-OF-CONTACT : REBOUL, Thierry, CEO,
therry.reboul@resa-electronique.com, +33 (0)1 60 92 33 41

TURNOVER 3.5 M€

WORK FORCE 40 employees

SPACE TURNOVER 2.5 M€

Satellites
Balloons
Transversal competencies



RESCOLL is a private research and development company in the field of innovative industrial applications of materials: composites, paints, coatings, resins, adhesives, ...

To do so, RESCOLL has R&D laboratories, clean rooms, but also characterization laboratories: ageing, mechanical and thermomechanical tests, fire behavior, physico-chemical analysis, ...

COMPETENCIES & CAPABILITIES

RESCOLL's main competence in the space field lies in the formulation of materials meeting the specifications of this field.

This activity consists in developing specific materials, mainly protective coatings, adhesives, functional paints, resins adapted to space constraints.

Its characterization laboratories allow the mapping of properties. Thanks to its subsidiary "RESCOLL Production", RESCOLL goes beyond the laboratory study and ensures the supply of the developed materials.



RESCOLL

PRODUCTS & SERVICES

Obsolescence issues are regularly found in the space domain.

The causes are numerous:

- lack of interest from suppliers of materials by the small quantities consumed by the space domain,
- disappearance of raw materials in the formulations used because of ReACH, for example,
- unavailability of products due to ITAR customs regulations,
- ...

Also in some dual applications, the "francization" of materials is an objective sought.

With more than 25 years of experience in materials formulation, RESCOLL has the know-how and the recognition to answer these obsolescence issues.

MAJOR SPACE PROJECTS & REFERENCES

For example, RESCOLL has:

- used its INDAR technology to enable the structural but reversible bonding of an INVAR crown to a SiC part for the GAIA satellite for ground tests.
- formulated hydrophobic silicon coatings to protect sounding balloons from icing
- formulated electrically conductive adhesives for onboard electronics applications
- developed Joule effect heating paints for thermal protection applications inside the satellite
- formulated ablative thermal protections (phenolic/cork, silicone, ...) for atmospheric re-entry
- functionalized materials by the formulation of metallic powders implemented by the "cold spray" technology
- ...

POINT OF CONTACT

ADDRESS 8, allée Geoffroy Saint Hilaire
33600 Pessac France

WEBSITE www.rescoll.fr

PHONE +33 (0)5 47 74 69 00

POINT-OF-CONTACT : Dr. Maxime OLIVE, R&D manager
maxime.olive@rescoll.fr; +33 (0)5 47 74 69

TURNOVER 13 M€

WORK FORCE 125

SPACE TURNOVER 1.5 M€

SPACE WORK FORCE 14

- Orbital systems
- Launchers
- Satellites
- Ground segments
- Cyber Security
- Transversal competencies



RHEA Groupe France is part of RHEA Group, a privately-owned engineering and solutions company, providing bespoke engineering solutions, security services and system development across Europe and in Canada, in particular the space sector, with the highest level of knowledge, expertise and experience.

RHEA's primary markets are Space, Defence and Critical Infrastructures.

The majority of our clients are governmental and institutional.

COMPETENCIES & CAPABILITIES

RHEA provides professional engineering services, develops and operates systems and solutions tailored to our client requirements, and offers state-of-the-art products in the systems engineering and cybersecurity domains.

RHEA was founded 30 years ago to support customers in spacecraft operations and AIT. RHEA has now developed a strong reputation for services, solutions and products delivery within the Space industry and the Cybersecurity domain. Based on its space heritage and security expertise, RHEA Group has unrivalled experience in cybersecurity for space.

We are a fast-growing company with about 800 staff in 11 countries. RHEA is ISO 9001 and ISO 27001 certified.



RHEA

PRODUCTS & SERVICES

RHEA's delivery capacity can be broadly categorised in 2 main areas:

- **Professional Engineering Services**, covering activities related to customer on-site and off-site RHEA engineering services. These activities include Engineering, Management, Scientific and IT Services on-site at the main premises of ESA, EUSPA and main European Space Industries.
- **Systems & Solutions**, covering customised development projects, services and products in the domains of Model-Based Systems Engineering, Data analysis and downstream applications, Ground Segment Solutions, Position Navigation and Timing (PNT), Space Situational Awareness (SSA), Secure Telecom (incl. QKD, QCI), AI and ML, Software Development and Maintenance, Operational Security Systems, Security Training, Threat and Risk Assessments, Organisational Security Management, Vulnerability Analysis, among others.

Our clients in the space sector include **ESA, EUSPA, the European Commission, EUMETSAT, ENISA, NATO, OHB and national space and defence agencies.**

MAJOR SPACE PROJECTS & REFERENCES

Over the past 30 years, RHEA Group has supported over 120 satellite missions including CubeSats, SmallSats, complex science spacecraft, EO and communication satellites, and multi-satellite constellations.

- **ESA EFC-2:** Industrial Support to ESA Directorates in Navigation, Earth Observation and Satcom (ESTEC, ESOC, ESRIN, ESAC, ECSAT, ESA HQ and EGNOS Project Office)
- **ESA/ESOC GOF 9:** Satellite and Ground Operations Support for Earth Observation and Science missions
- **EUSPA and EC Support Services:** exploitation and evolution activities for the European Space Programmes: Galileo, EGNOS, Gvsatcom and Secured telecoms, Copernicus and SSA.
- **Luxembourg DoD: NAOS** (EO satellite) - LUXEOSys Ground Segment Operations and Maintenance
- **ESA SCCoE:** Space Cyber Security Centre of Excellence
- **ESA C-SOC:** ESA Cyber Safety and Security Operations Centre

POINT OF CONTACT

ADDRESS 5 Avenue Pierre-Georges Latécoère, Bâtiment B
31520 Ramonville Saint-Agne - France

WEBSITE <https://www.rheagroup.com/fr/>

PHONE +33 (0)6 25 03 11 72

POINT-OF-CONTACT: PIALOT Laure, Sales Manager
l.pialot@rheagroup.com, +33 (0)6 25 03 11 72

TURNOVER 100+ M€

WORK FORCE 800 employees

SPACE TURNOVER 90%

SPACE WORK FORCE 90%

Orbital systems
Launchers



RIDE! designs and operates the world's first digital launch platform as a service. In other words, RIDE! seamlessly connects supply and demand for the entire launch process via its platform (from launch to deployment solution to insurance, etc.).

Plus, we support satellite operators throughout the management of the launch mission with a category of off-the-shelf services.

COMPETENCIES & CAPABILITIES

We have developed 3 skills :

1. **Risk Management:** Supporting satellite operators throughout the selection process of the best launch providers on RFP and by being in contact with the launchers, we have developed a detailed knowledge of the characteristics of each launchers (operational or in development) in order to reduce the risks taken by satellite operators during their final choice, both on financial and technical issues.
2. **Launch Mission Management:** Accompaniment of satellite operators on key Launch Mission Management services (radio frequency registration, choice of insurer, UNOOSA registration)
3. **New Space intelligence,** writing of sector reports and setting up of training sessions related to the space industry and expertise.



RIDE!

PRODUCTS & SERVICES

We've developed 3 products:

- A digital platform that allows satellite operators (academic, private unique or in constellation) and launchers to meet through a digital platform. Operators see their processing times shortened due to easy access to information, while launchers are given a new acquisition channel.
- We support satellite operators throughout their mission to provide them with the necessary services so they can focus on what they really do. These services can be: testing and integration, choice of insurer, registration at UNOOSA, choice of radio frequency...
- Report and training to support satellite operators on specific topic related to the Launch Mission Management, the space industry or the choice of the best launch providers

MAJOR SPACE PROJECTS & REFERENCES

We have assisted several satellite operators in the choice of the most relevant launch Vehicle for their mission regarding their needs. Example of one of the last missions for a satellite operators: 20 launchers solicited, 8 launchers audited, 3 launchers shortlisted, 1 launcher selected.

Time saved: 2 months by soliciting and structuring the RFP and facilitating communication between the parties.

We have developed a series of services to support satellite operators in specific missions such as ITU registration or insurance choices.

POINT OF CONTACT

ADDRESS 4 rue Jules GUESDE, 91130 Ris, France

WEBSITE www.ridespace.io

PHONE +33 (0)6 61 51 09 97

POINT-OF-CONTACT : Gautier BORIES, COO, Gautier.bories@ridespace.io

TURNOVER

WORK FORCE 3 employees

SPACE TURNOVER

SPACE WORK FORCE 3 employees

Launchers
 Ground segments
 Balloons
 Transversal competencies



The SAS RTIME company is specialized in flight hw&sw instrumentation, small and large software development for aerospace applications, unique modeling methods and simulation tools for inflatable structures. The company is a small and responsive structure with a tailored work answering specialized client's requirements. Our priority is the work quality we offer.

COMPETENCIES & CAPABILITIES

Flight hardware developments: designing, manufacturing, electronic developments of specialized sensors with emphasis on optical devices.
 Instrumentation software development: complete advanced software for ground command control and data processing, onboard firmware development.

Software developments for space rockets telemetry. State of the art high performance video processing for space rockets.

Software developments for large multiplatform databases.

State of the art thermo-optical-fluid modeling applications for earth and extraplanetary missions.

Modeling and calculation of inflatable structures.

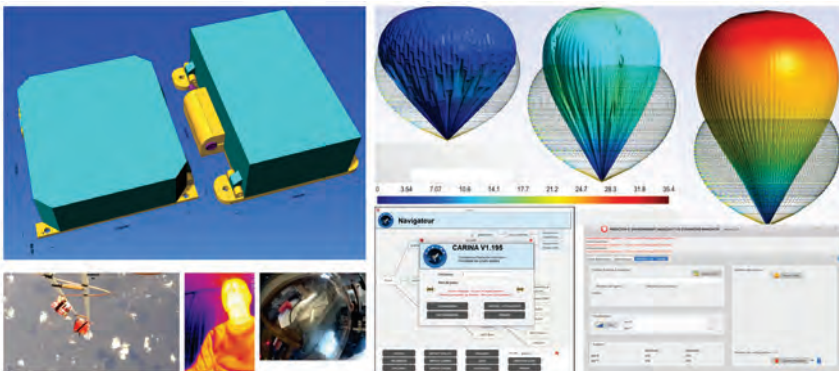

RTIME

PRODUCTS & SERVICES

The SAS RTIME company manufactures a complete autonomous flight instrument used by major space companies. It is qualified for very long duration stratospheric environments and can also be remotely connected. Launched from many sites: Canada, Sweden, Australia. Onboard, air and ground surveillance for long missions.

Several key software delivered and used for space rocket applications (Ariane, Vega, Soyuz) using various programming languages. Emphasis on telemetry as well as video processing.

Many customized software developed according to unique client's needs: large database and large data set processing, flight modeling, state of the art physical modeling for coupled systems with thermal analysis, optical ray tracing and fluid modeling.

Development of software dedicated to the calculation of stratospheric balloons using the dynamic relaxation method. Simulation of structures with material, geometrical and loading and local buckling phenomena characterized by the appearance of wrinkles.

MAJOR SPACE PROJECTS & REFERENCES

The SAS RTIME company is proud to participate and collaborate on key projects for:

- the French space agency CNES,
- the Thales Alenia space company,
- the CS company.

Tight links with French research laboratories such as the Univ. Bretagne Sud.

POINT OF CONTACT

ADDRESS SAS RTIME – 6 RESIDENCE LES CHATAIGNIERS
09000 VERNAJOUL - FRANCE

WEBSITE <http://www.rtime.fr>

PHONE +33 (0)5 61 64 74 98

POINT-OF-CONTACT : Dieudonné Walter, Company president,
contact@rtime.fr

TURNOVER 0.15 M€

WORK FORCE 2

SPACE TURNOVER 0.10 M€

SPACE WORK FORCE 2

Orbital systems
Satellites
Transversal competencies



For over 50 years, the Space Electric Propulsion Directorate of Safran Aircraft Engines has been developing, integrating and testing chemical and electrical propulsion systems for spacecraft.

Safran Aircraft Engines is now a leading world player in electrical propulsion systems, especially advanced Hall Effect thrusters

COMPETENCIES & CAPABILITIES

The Space Electric Propulsion Directorate is proposing:

- A complete range of Hall Effect thrusters (rated at 200 W to 20 kW) for Satellite station keeping, Orbital transfer and positioning, space exploration and navigation,
- Thruster modules and systems designed and built by Safran Aircraft Engines.

Safran Aircraft Engines is used to perform the following tasks:

- A post launch “on-site” support for the first Flight,
- Subcontractor assistance to spacecraft AIT,
- EGSE for spacecraft AIT,
- Subsystem or system End-to-End testing.

A complete range of plasma thrusters

(200 W to 20 kW)

- Satellite station keeping
- Orbital transfer and positioning
- Space exploration and navigation



PPS® X00 (200 – 1000 W)
• Under development
• Qualification in Q2 2022



PPS® 1350-G/S (1,500 W)
• Qualified in 2006
• Used on Alphas (2013) and Smart-1 (2003)
• Qualified with single cathode in 2016



PPS® 1350-E (2,500 W)
• EM test in 2014
• Environmental Qualification done in 2017



PPS® 5000 (5,000 W)
• First test in 2006
• Environmental Qualification completed
• EOR Qualification review completed
• NSIC Qualification on 2020/2021 according to mission needs



PPS® 20K (20,000 W)
• Successfully tested in 2011

Thruster modules and systems designed and built by Safran



Thruster Module Assembly (TMA)
• 16 modules for Eurostar 3000 platforms orbited since 2004



Electric Propulsion Thruster Assembly (EPTA)
• Delivered for Small Geo in 2012

SAFRAN AIRCRAFT ENGINES

PRODUCTS & SERVICES

Main Hall Effect thrusters in Safran portfolio:

- PPS®X00 (200-1000W)
Low-cost thruster optimized for high production rate aiming medium and large constellations
Thrust range: 15-75 mN // Total impulse: 1 MN.s
- PPS®1350 (1500-2500 W)
Designed for orbit-topping and station-keeping
Thrust range: 90-140 mN // Total impulse: 3.4 MN.s
- PPS®5000 (2500-5000 W)
Designed for all-electric satellites (orbit raising & station keeping)
Thrust range: 100-300 mN // Total impulse: 14.5 MN.s

MAJOR SPACE PROJECTS & REFERENCES

The PPS®1350 demonstrated its capabilities during ESA's Smart-1 probe's mission from Earth orbit into orbit around the Moon. Four of these thrusters handle North/South station-keeping duties on the Alphasat satellite, launched in 2013. It was selected by Space Systems Loral in 2015 and will equip Astranis satellites (first launch scheduled in 2020).

The PPS®5000, developed in the frame of the PIA2 programme, has been selected by Airbus Defence and Space, Thales Alenia Space and OHB for use on their Eurostar Neo, Spacebus Neo and Electra satellite platforms, respectively. It has also been selected by Boeing company in 2016. First flight planned in 2021.

The PPS®X00 has started its development early 2017 under H2020 European project through CHEOPS consortium. In 2018 CNES will also support this development through ESA ARTES program line.

POINT OF CONTACT

ADDRESS Campus de l'Espace - 1 avenue Hubert Curien - CS30820 F-27207 Vernon Cedex - France

WEBSITE www.safran-aircraft-engines.com/satellite-propulsion-future-electric

PHONE +33 (0)2 32 64 88 01

POINT-OF-CONTACT : Xavier CAVELAN, Programs Contract & Sales Director
xavier.cavelan@safrangroup.com

TURNOVER € 10.452 billion (2018)

WORK FORCE 16,700 (2018)

SPACE TURNOVER -

Orbital systems
Launchers
Satellites
Transversal competencies
Transversal competencies



Safran Electronics & Defense is one of the world's leading providers of tailored solutions for both civil and military applications. Along with our subsidiaries, we also develop very high-tech solutions for some of today's most ambitious space and astronomy programs, including telescopes, optical instruments, test equipment, navigation systems, electronics and hybrid microelectronics. The company masters volume production with in-house MAIT facilities.

COMPETENCIES & CAPABILITIES

Unmatched range of proprietary in-house technologies for severe environment in satellites, launchers, aircraft, missiles, UAVs, land and sea platforms.

One-stop shop electronics: analog, digital, power, mixed Design and manufacture of:

- High-precision inertial sensors, equipment and algorithms,
- High-precision optics and optronics,
- Micropackaging technologies including build-to-spec and build-to-print services,
- Space motors and sensors using automatic wiring.
- ESA-qualified manufacturing facilities expertise labs.

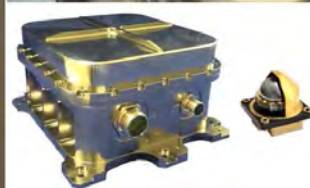

SAFRAN ELECTRONICS & DEFENSE

PRODUCTS & SERVICES

Navigation and guidance solutions such as INS, IMU, ring laser gyros (RLG), fiber optic gyros (FOG), resonator gyros (HRG), MEMS, GNSS receivers, accelerometers.

Power distribution and supply electronics: PPU, PDU, DCDC converters, DCAC inverters, up to 200 kW for space applications

Actuators and actuation electronics:

- up to 10 kW;
- solar array drive, antenna pointing mechanism, berthing and docking
- mechanism for satellites and capsules;
- pumps primary and secondary flight control systems (FCS) for aircraft and valves for rocket engines;

Propulsion systems regulation and control for aircraft (FADEC), rocket (REEC) and satellite (PPU).

Front-end electronics for various detectors: UV, visible, IR, XRay, gyros, accelerometers.

MAJOR SPACE PROJECTS & REFERENCES

Arabsat, Eutelsat, Turksat, Turmensat, Telkom, AM33/44, AMOS 4&5, ARSAT, ATHENA FIDUS, CIEL2, Chinasat, YAMAL401, Hispasat, Meteosat, O3B, W2A, W3B, W3C, W3D, YAHSAT, LOUTCH 4&5, Nilesat, PALAPA-D, RQ1R, RASCOM,

Sinosat, THOR 6, IASI, SPOT Family, HELIOS, Polar Platform, Columbus Orbital Facilities, Kazsat, GLOBALSTAR, PLEIADES, COROT, ARIANE, ASTRA, DFH4, KOREASAT, MD1/MD2, Paksat, STAR ONE, SUPERBIRD, SYRACUSE3,

Falcon Eyes, M4, M51, CSO, RUAG, Konsberg, ISS Reshtnev, COMAT, CEA, ... Space optics: refer to Safran Reosc.

POINT OF CONTACT

ADDRESS Arcs de Seine - 18/20 Quai du Point du Jour

F-92659 - Boulogne Billancourt - Cedex - France

WEBSITE www.safran-electronics-defense.com

PHONE +33 (0)1 55 60 38 00

POINT-OF-CONTACT: Frédéric Varastet (Sales & Marketing Space)

TURNOVER €1,239B

WORK FORCE 7,600

SPACE TURNOVER €18m

SPACE WORK FORCE 150

Orbital systems
Satellites
Transversal competencies



Part of the Space Direction of Safran Electronics & Defense, **Safran Reosc** is the European leader in high-performance space optics with 50 years of cooperation with CNES, Airbus, TAS and OHB, recognized by ESA, DLR, ISA, ISRO, JAXA, KARI, NASA, FFI, ISA, CAST ...

We deliver the latest and most high-performance space optics and camera for earth observation, weather forecast, science, environment monitoring and Space Situation Awareness.

COMPETENCIES & CAPABILITIES

From spec to final product we offer:

- Lens design & mechanical engineering,
- Ultra-lightweight glass machining for large size optics,
- Robotic polishing of aspheres & freeform, in metal, glass or SiC, from a few cm to 4-m size, IBF & MRF figuring,
- Accurate metrology bench design and calibration,
- UV-Vis-IR thin film deposition up to 1.6-m aperture, thin film 2D structuration and pixelated coatings,
- Lens assembly, telescope integration and final performance evaluations in ISO-5 clean room,
- Program & quality management per space standards.

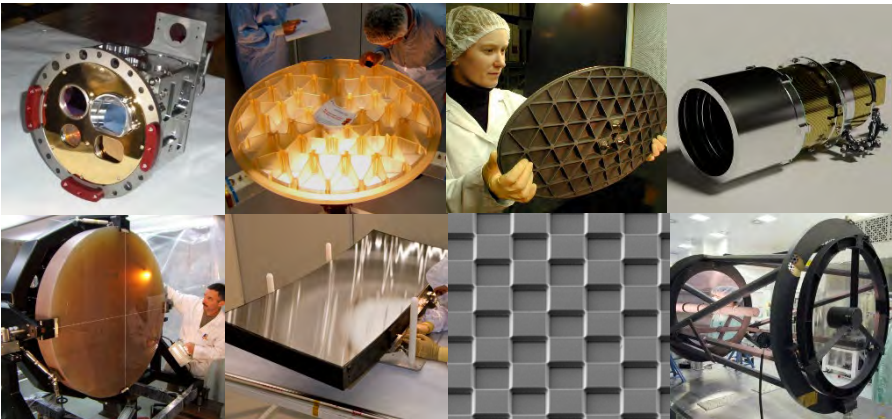

SAFRAN REOSC

PRODUCTS & SERVICES

Safran Reosc offers critical products & services for optical earth observation, weather forecast, science & environment monitoring:

- Precision lens design & mechanical engineering,
- Lightweight mirrors and fixtures (metal, glassy, SiC),
- High performance Vis-IR dioptic optics,
- Vis-IR filters & thin films, down to cryogenic temperature
- Flexible supply from single component, opto-mechanical module to full telescope or equipment,
- Precision collimators & reference flats for ground testing,
- Ultra-low SWaP space cameras for nanosatellites.

MAJOR SPACE PROJECTS & REFERENCES

Earth observation: Spot, Helios, CSO, Perusat, KazEOSat-2, VNRED, Ofeq, Formosat, Cartosat, Oceansat, Kompsat-2 & 7, Pleiades Neo

Meteo: Meteosat, MSG, MTG, METOP, IASI, IASI-NG, Gaofen-5, INSAT

Science: Orfeus, Solar-B, Solar Dynamic Observatory, Gaia, Hipparcos, Corot, ISO, JWST NIRSpec, Euclid, JUICE

Environment: Aeolus, EarthCARE, Merlin, Microcarb, Copernicus LSTM

Test Equipment: Precision large flats & collimators for TAS, Airbus, CNES, ESA, NASA, JAXA, ELOP, ISRO, KARI

Nanosat cameras for NorSat-4 and JAPETUS constellation.

POINT OF CONTACT

ADDRESS Avenue de la Tour Maury
F-91280 - Saint-Pierre-du-Perray - France

WEBSITE www.safran-reosc.com

PHONE +33 (0)1 69 89 72 00

POINT-OF-CONTACT: Luc THEPAUT (Sales)
luc.thepaut@safrangroup.com

TURNOVER €35M

WORK FORCE 180

SPACE TURNOVER €20M

SPACE WORK FORCE 130

Satellites
Transversal competencies



Founded in 1918 in France, Saft is the world's leading designer, developer and manufacturer of advanced technology batteries for industrial, terrestrial, space and defence applications is now very well-positioned on the developing markets of clean vehicles and renewable energy storage.

COMPETENCIES & CAPABILITIES

The battery industrial know-how relies on a large subset of competencies, among which the in-depth knowledge of the electrochemistry fundamentals, the experienced control of key industrial processes or the ability to design large and complex battery systems represent core skills.



SAFT

PRODUCTS & SERVICES

Saft believes that battery space-grade equipment should be designed and manufactured under space-qualified and controlled processes over all the chain of value, to ensure long-term performances in space environment. Battery control, balancing and protection are essential to assure long-term battery health and provide battery information and forecast. Saft is today the only company to offer in a comprehensive industrial coverage and provides its customers with a best-in class service ranging from electrochemistry design (materials and electrodes research and manufacturing) to in-orbit support taking into account cells development, qualification and manufacturing, battery assembly and testing.

MAJOR SPACE PROJECTS & REFERENCES

Saft is the European space battery leader supplier since 1966. Saft has been involved in all the major European and worldwide space programs during more than 54 years: Spot, GPS, DMSP, Meteosat, ATV, worldwide GEO communication satellites from Eutelsat, SES, Intelsat, Inmarsat...and constellations such as Iridium Next with Thales.

Saft is the sole company to have qualified and produced the three main space rechargeable cell technologies (NiCd, NiH₂ and Li-Ion). More than 950 satellites have been powered with Saft batteries since 1966.

Also Saft delivered the batteries for all the Ariane and VEGA launches. In addition, Saft Lithium primary batteries LiSO₂ and LiSOCL₂ were used on specific missions such as ATV, Philae, Mascot.

POINT OF CONTACT

ADDRESS rue G. Leclanche - BP 1039
F-86060 - Poitiers cedex 9 - France

WEBSITE www.saftbatteries.com

PHONE +33 (0)5 49 55 47 92

POINT-OF-CONTACT : P. Michelet

TURNOVER €788m (2018)

WORK FORCE 4,300

SPACE TURNOVER €26m

SPACE WORK FORCE 130

Satellites
 Balloons
 Transversal competencies



For more than 35 years, we have been bringing our know-how in terms of high precision machining to various major players in the space and electronics fields. Relationships of trust and close cooperation have been built with all our partners.

SAP Micromécanique offers its expertise as a machinist with the same commitment: to offer the best technical solutions for the production of increasingly complex and precise products.

COMPETENCIES & CAPABILITIES

- The Space domain
- Hyper frequency,
- The very high precision
- Assembly tooling
- Laser reflector supports (laser Tracker)
- Work design
- Mechanical calculation
- Drafting and documentation (instructions for use, risk analysis,)
- Industrial design

We have been ISO 9001:2015 certified since May 2018.



SAP MICROMECHANIQUE

PRODUCTS & SERVICES

Precision machining
Micromechanical machining
Design office
Control
Quality

MAJOR SPACE PROJECTS & REFERENCES

EYESAT
ANGEL
SOLAR ORBITER
MICROCARB
MWI-MWS
EUCLID
IASI-NG
TARANIS
NAOMIX
ATLID
SENTINEL
HELIOS
MARFEQ

POINT OF CONTACT

ADDRESS 130, rue Lamartine
81500 AMBRES, France

WEBSITE www.sap-micro.com

PHONE +33 (0)5 63 58 71 12

POINT-OF-CONTACT : DE LAZZARI Thierry , Director, 05 63 58 71 12

TURNOVER 3.2 M€

WORK FORCE 21 employees

SPACE TURNOVER 2.8 M€

SPACE WORK FORCE 21 employees

Orbital systems
 Ground segments
 Transversal competencies



Sapienza Consulting France is a provider of mission and business critical solutions for governments, institutions and leading commercial businesses to add value and deliver successful programs on land, sea, in the air and in space. We provide Consulting & Engineering services and IT solutions, we work in areas related to **space** programs, national **security** and **energy** supply that are critical to a safe and prosperous society.

COMPETENCIES & CAPABILITIES

Sapienza Consulting France is a trusted partner for innovation and delivery in France. We cover the space domains: Observation, Telecom and Navigation with an offer based on 4 pillars:

- Our Eclipse software suite, an Engineering and Project Management solution for space development and operations based on ECSS standards.
- Professional & Quality space services like configuration /documentation management, Product Assurance.
- Technical expertise (SW IVV, System Engineering) through agile or V-cycle process.
- Innovation solutions with 5G satcom for critical applications, Applied AI for SSA/SST applications and green H2 production.



SAPIENZA CONSULTING FRANCE

PRODUCTS & SERVICES

We are part of an European group, **TP Group**, who is a global leader in consulting, digital solutions and engineering services across the full lifecycle of defense, space and energy programs. TP Group employs approximately 450 people in six countries, with customers in more than 30 countries across three complementary domains:

- **Consulting**, working in partnership with national government bodies, international institutions and global prime contractors on enterprise transformation, feasibility analysis, system engineering, program delivery and support.
- **Digital Solutions**, developing mission and safety critical systems, software tools, artificial intelligence and decision support for autonomous navigation, constellation management, collision avoidance, resource optimization, intelligence analysis and asset management.
- **Bespoke Engineering Solutions**, including life-support systems in critical workspaces, hydrogen based renewable energy solutions, water purification, rugged electronics for harsh environments and precision engineering of high-integrity equipment.

MAJOR SPACE PROJECTS & REFERENCES

In France,

- ESA (ESA V2/V3 program)
- AIRBUS D&S
- THALES ALENIA SPACE
- NAVAL GROUP

In Europe,

- UK MoD (Skynet programs)
- OHB
- EUROCONTROL
- GSA

POINT OF CONTACT

ADDRESS B612 – 3, rue Tarfaya
31400 Toulouse France

WEBSITE www.tpgroupglobal.com

PHONE +33 (0)6 81 16 66 68

POINT-OF-CONTACT: BERENBACH Frederique, Aerospace Director,
frederique.berenbach@sapienzaconsulting.com, +31 6 15 22 77 77

TURNOVER NA - Launched in 2020

WORK FORCE 9 employees

SPACE TURNOVER NA - Launched in 2020

SPACE WORK FORCE 7 employees

Orbital systems
Satellites
Ground segments
Transversal competencies

SatConseil

SatConseil is an independent consulting firm based in Toulouse, dedicated to the space sector. We support your development, de-risk your programs and manage your projects, bringing you the added value of our strengths: strategic vision, management, expertise and network.

COMPETENCIES & CAPABILITIES

Our services are based on over 35 years' experience in the space industry, covering expertise in R&D projects, payloads and telecommunications satellites, space applications or telecommunications management, data collection or search and rescue programmes.

We bring you the analysis, the expertise and the perspective necessary to facilitate your decision-making process in the definition and implementation of your development strategy.

We clarify situations by helping you to analyze and understand your environment and by identifying the growth drivers available.

We understand your needs, the challenges of the sector and we are able to intervene at different levels in the value chain.

SatConseil

PRODUCTS & SERVICES

Our service offer is based on a system of values specific to our history and beliefs. These are centered on trust and commitment

- Support for the development and implementation of new programs,
- Strategic diagnosis, business plan, support to the definition of a development strategy
- Management assistance (eg: Contribution to the drafting of RFP, evaluation of the answers, contribution to the drafting of proposals, contractual negotiations, organization and project monitoring, program management)
- Organization, implementation, and animation of technical events.

MAJOR SPACE PROJECTS & REFERENCES

- Project management assistance for hosting the EGNOSV3 control centre in Toulouse,
- Project management assistance for hosting the EGNOS V3 RIMS in Paris,
- Setting up a French NewSpace observatory
- Project manager for France's application to the ECMWF
- Advising a foreign company on its development in Europe,
- Support for the transformation strategy of a company into an intergovernmental organisation,
- Development of a "Space and Climate" roadmap.
- Clients: Aerospace Valley, ALE (Japan) Aerospace Valley, ALE (Japan), CNES, Loft orbital, Observatoire de Paris-PS, Mercator Ocean, TéSA, Toulouse Métropole.

POINT OF CONTACT

ADDRESS 17 chemin des rosiers, 31130 Toulouse France

WEBSITE www.satconseil.eu

PHONE +33 (0)6 33 27 68 33

POINT-OF-CONTACT : LUVISUTTO, Eric, CEO, contact@satconseil.eu

TURNOVER NA

WORK FORCE NA

SPACE TURNOVER NA

SPACE WORK FORCE NA

- Orbital systems
- Launchers
- Satellites
- Ground segments
- Balloons
- Transversal competencies



Satconsult supports its customers in the implementation of sustainable satellite-based telecommunications and earth observation infrastructure worldwide. Satconsult is a subsidiary of Euroconsult since August 2016. Together, we provide an end-to-end service capability to the space sector globally. Together, the team covers the full spectrum of customers' requirements in the satellite industry including market, financial, technical, operational and legal assessments and represents the largest advisory group in the satellite sector.

COMPETENCIES & CAPABILITIES

Satconsult brings global support to its clients, including multiple skills ranging from technical consulting and program management and construction monitoring to business/commercial development and legal/spectrum/regulatory aspects. Its service portfolio covers the complete lifecycle of a satellite project from feasibility analysis to system operation. At the project inception stage, Satconsult assesses market potential, draft the business plan and develop the request for proposals. It then provides support at each step of the procurement and construction phase, from bid reviews to on-site monitoring and in-orbit testing. Finally, it provides satellite operation support and contribute to the definition and implementation of strategic development (sourcing partners, investors, and investment opportunities).

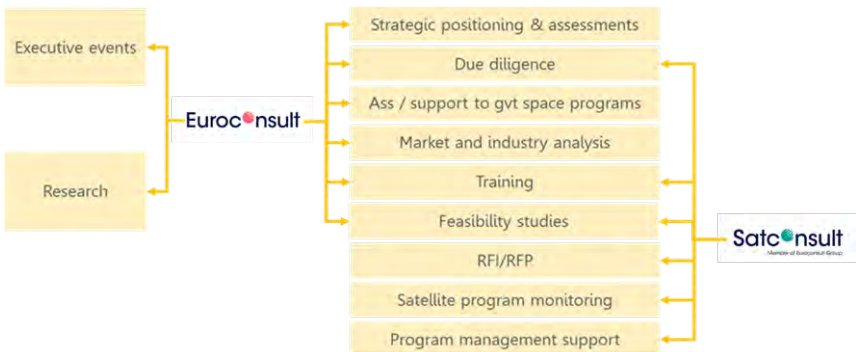

SATCONSULT

PRODUCTS & SERVICES

Satconsult has more than 50 customers in developed and emerging space markets, in all regions of the world, including satellite operators, governmental and international organizations (space agencies, regulatory bodies, etc.), financial institutions (private banks, commercial banks, private equity funds, etc.), insurance brokers and insurance companies. Satconsult has developed expertise and know-how around a portfolio of services and capabilities covering the complete lifecycle of a satellite project, from feasibility studies and project development to operations and training support.

The positioning of Satconsult is divided into four support services:

- Feasibility studies & project development
- Procurement
- Contact execution & construction monitoring
- Operations & training

MAJOR SPACE PROJECTS & REFERENCES

Feasibility Studies:

Canada DND: engineering and costing analysis of a space-based optical and hyperspectral surveillance system

ESA: Developing the Preliminary Design of a European Secure Satcom Pooling & Sharing System for Global Markets, etc.

Procurement support to various satellite operators:

Support to specifications writing, offers evaluation, bidders ranking and final negotiation with the preferred satellite manufacturer (Telkomsat HTS 113 EL, ARSAT SG1, TurkSat 5A & 5B, etc.)

Satellite contract monitoring:

Hispasat Amazonas Nexus, Bakti Satria 1, ADD KMilsat, etc.

POINT OF CONTACT

ADDRESS 36 rue du Languedoc
31000 Toulouse, France

WEBSITE www.satconsult.eu

PHONE +33 (0)5 34 31 75 81

POINT-OF-CONTACT: Chégnion David, Managing Director
chegnion@satconsult.eu, +33 (0)7 87 16 68 30

TURNOVER 3 M€

WORK FORCE 10 employees

SPACE TURNOVER 3 M€

SPACE WORK FORCE 10 employees

Ground segments



ScalAgent DT is an independent software vendor, expert in asynchronous middleware.

ScalAgent DT provides middleware products and expertise to help you in designing and prototyping your distributed systems.

COMPETENCIES & CAPABILITIES

We have initiated, in close cooperation with CNES, the space industry standard CCSDS MAL. We have also designed MAL/JORAM, a reference implementation of this standard.

We are experts of the CCSDS MAL standard and of other related MAL services standards. As such we have participated to a lot of prototyping of those standards.

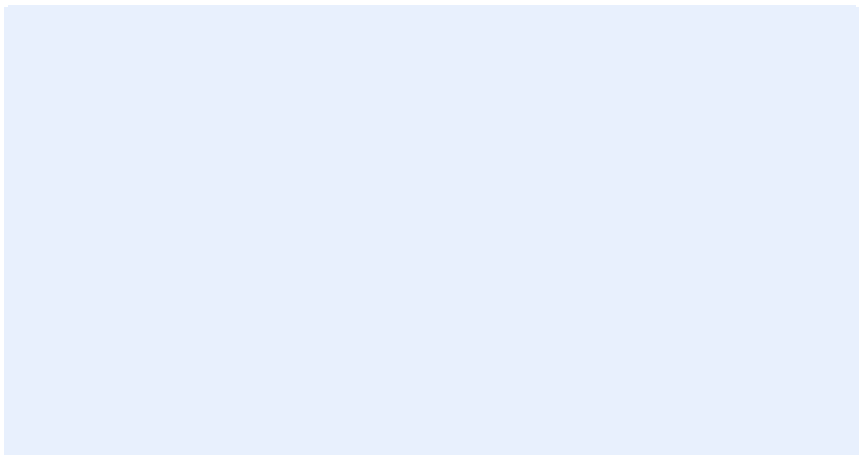

ScalAgent D.T.

PRODUCTS&SERVICES

ScalAgent DT is an independent software vendor, expert in asynchronous middleware. Our main offering is the JoramMQ product, a multi protocol MOM compliant with various standards (JMS, AMQP, MQTT, REST, ...).

We also promote our expertise through various services, such as architecture design, reviews, prototyping, of distributed systems.

MAJOR SPACE PROJECTS & REFERENCES

We are working in the context of the CCSDS since 2006:

- study, development and discussions leading to the CCSDS MAL standard; reference implementation of the standard in java
- definition of a standard Java API to the CCSDS MAL
- definition of a standard C API to the CCSDS MAL; reference implementation in C over ZMQ
- contribution to and/or prototyping of various CCSDS standards: COM, Common, SPP encoding, TGFT
- MAL conformity study of a product for the CNES

POINT OF CONTACT

ADDRESS ScalAgent D.T. - 2 bd des Anciens d'Algerie
38580 Allevard - France

WEBSITE www.scalagent.com

PHONE +33 (0)6 86 47 41 06

POINT-OF-CONTACT: Lacourte, Serge, CEO, serge.lacourte@scalagent.com
+33 (0)6 86 47 41 06

TURNOVER 0,2 M€

WORK FORCE 2 employees

SPACE TURNOVER 0,1 M€

SPACE WORK FORCE 2 employees

Orbital systems
 Satellites
 Ground segments
 Transversal competencies



As a leading international provider of solutions and expertise, SCALIAN Group is a confirmed specialist in the fields of Transformation, Operations Performance and Systems.

In its consulting business, SCALIAN provides support to leading industrial and service-sector companies to help them define and implement their complex projects and technologies.

COMPETENCIES & CAPABILITIES

- Quality assurance for spatial programs
- PMO for spatial programs
- Test benches (system, AIT)
- Simulation studies (optronics, radar, oceanology)
- Mechanical studies
- Payloads & platforms developments and data processing



SCALIAN

PRODUCTS & SERVICES

Strategy & Transformation:

- Digitalisation & Data Exploitation: User experience, AI, Cybersec
- Business Platforms & Solutions: Big Data as a service
- Business & Operating models: Innovation, technology/market watch, transformation of organisations

Operations Performance:

- Enterprise performance: management systems, product/process quality assurance
- Project performance: management of projects & programs
- Industrial performance & Supply chain quality
- Purchasing performance: Operational procurement, purchasing organization & tools

Digital Systems:

- Complex Systems (embedded/autonomous/critical systems, tests facilities, simulation, virtual & augmented reality & HPC)
- Information Systems (functional/digital solutions, digital factory, networks/infrastructure & support)

MAJOR SPACE PROJECTS & REFERENCES

SCALIAN has been involved in these space projects: Myriade (Demeter to Taranis), Argos, SKIM, EGNOS, Sentinel 2, Pleiades, SYRACUS 4, FALCON EYE, V2020, KMILSAT, EGYPT, Vulcain, Ariane 5/6, Neosat, Inmarsat 7, ...

SCALIAN customers: CNES, Airbus DS, Thales Alenia Space, ArianeGroup, Telespazio, CLS, ESSP

Some references:

- Myriade BVSS
- LMS Flight Software & Digital Engineering Ariane 6
- Software Quality Assurance (ECSS E40)
- R&T Influence of ocean currents / properties of waves

POINT OF CONTACT

ADDRESS 417 L'Occitane
31670 LABEGE France

WEBSITE www.scalian.com

PHONE +33 5 61 00 79 79

POINT-OF-CONTACT: Jean-Frédéric REAL, Marketing & Innovation Director,
jean-frederic.real@scalian.com, +33 6 14 40 66 83

TURNOVER 219 M€

WORK FORCE 2800 employees

SPACE TURNOVER 16 M€

SPACE WORK FORCE 160 employees

Orbital systems
 Launchers
 Ground segments
 Transversal competencies



SCASSI is a pure player in cybersecurity specialized in critical and embedded systems, certified by French National Cybersecurity Agency (ANSSI) as a PASSI/LPM.

SCASSI's teams are composed of experts who have extensive knowledge of the unique cybersecurity requirements of specific sectors like Defense and Space.

COMPETENCIES & CAPABILITIES

Ebios RM Risk Analysis, Critical Information system, homologation, Audits PASSI/LPM, CMMC compliance, Ground and embedded system security architecture, Security requirements assessment, Penetration Tests, Security Operation and Maintenance.

SCASSI managed SIEM for SME, Chief Information Security Officer support on Space, Defense, or dual programs.

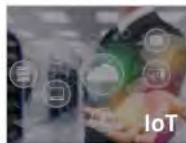

SCASSI

PRODUCTS & SERVICES

A few examples of projects carried out by SCASSI engineers:

- Risk analysis and technical support to secure space simulators
- EBIOS risk analysis relating to a complete system that offers services relating to space object management (SSA - Space Situational Awareness Program)
- Risk analysis, definition and processing of security requirements on dual systems (civil/military)
- Study and securing of collaborative GED/CMS type platforms handling sensitive information and for components of ground segments or payload.
- Support program for security applications
- Cybersecurity study for networks and data centers
- Support for accreditation of ground systems
- Support to secure technologies under Export Control
- Drafting of approval documentation
- Support towards MPL conformity

MAJOR SPACE PROJECTS & REFERENCES

Main customers: CNES, Airbus D&S, ESA/EuSPA, ESSP, EREMS, GTD, SOTEREM, ...

Main projects: RLSP, GALILEO, EGNOS, Ariane, DLA, CERES, ISIS/CSO, PLEIADE NEO, COPERNICUS DIAS, and other confidential programs...

POINT OF CONTACT

ADDRESS 209, rue Jean Bart
31670 Labège - France

WEBSITE www.scassi.com

PHONE +33 (0) 5 61 17 08 54

POINT-OF-CONTACT : Bory, Patrick, Defense & Space Skill Center Leader
patrick.bory@scassi.com, +33 6 67 80 27 54

TURNOVER 3.4 M€

WORK FORCE 35

SPACE TURNOVER 1.5 M€

SPACE WORK FORCE 15

Orbital systems
Satellites
Ground segments
Transversal competencies



Scienteama, founded in 2017, defines itself as a technological exploration entity. A real transition between the mode of fundamental and academic research focusing on the emergence of new concepts and the industry which seeks to open new markets by capitalizing on innovations.

COMPETENCIES & CAPABILITIES

- SCIENTIFIC, INDUSTRIAL, SPACE INSTRUMENTATION (TOMOGRAPHY, RADARS, SONARS, TRANSCIVERS...)
- ANTENNAS, EXTREME NOISE AND ULTRA-SMALL SIGNALS SENSORS, RECONFIGURABLE AND DEPLOYABLE SYSTEMS
- SATELLITE DATA AND CLIMATE SOLUTIONS, GEOLOGICAL ANALYSIS, BIOMASS AND EROSION



SCIENTEAMA

PRODUCTS & SERVICES

- Analysis of your need
- Feasibility study
- Drafting specifications
- Solve a problem
- Modeling / Simulation
- Analysis / Expertise
- POC - Proof of concept

MAJOR SPACE PROJECTS & REFERENCES

POINT OF CONTACT

ADDRESS : 4 AVENUE DE CAMBRIDGE
14200 HEROUVILLE SAINT CLAIR, FRANCE

WEBSITE <https://www.scienteama.com>

LINKEDIN www.linkedin.com/company/scienteama/

POINT-OF-CONTACT : BENOIT AGNUS
scienteama@gmail.com

Transversal competencies



SECTOR is an independent consulting and research company specialized in the area of risk management.

Main sectors of our activities are aeronautics, space and defence. For 30 years, SECTOR has been carrying out RAMS (Reliability, Availability, Maintainability, Safety), ILS (Integrated Logistics Support) and maintenance engineering studies in order to help our customers meet their performance requirements.

COMPETENCIES & CAPABILITIES

In the space industry, SECTOR is able to perform system or component (hardware and software) engineering studies in RAMS and ILS, including :

- RAMS Methods : Hazard Analysis, FMECA, FTA...
- Reliability calculations (electronics, mechanics...);
- Safety architecture specifications;
- ILS deliverables : maintenance plan, logistic tree, maintenance manual...

SECTOR

PRODUCTS & SERVICES

SECTOR is offering engineering services which can take many forms:

- Fixed Price studies and Analysis,
- Project Team : Integrated or Externalized
- Technical assistance,
- Consulting & Expertise,
- Trainings : Intra-Company (Customize) / Inter-Company (On Catalogue)

MAJOR SPACE PROJECTS & REFERENCES

Our main projects in space industry are the following :

- CNES : technical support for operational launch activities
- CNES : Bibliographic analysis and REX data collection for the principles and practices related to "High Reliability Organisation" (HRO), so as to adapt them to the context of ARIANE launchers for all operations preparatory to launch (assembly, filling, checks,...)
- CNES : Audit and analysis mission on the risk analysis process of operational procedures (analysis of incidents / anomalies, human factors, tools, etc.)
- CNES : An update of the risk analysis and Operational Safety allocations of the system's ground resources Ariane 5 ME launch
- CEGELEC : RAMS study of a system for cooling the Ariane launch pad assembly
- ECA : RAMS study on the Ariane 6 Booster assembly workshop (ESR means and Rear Skirt).
- LATESYS: RAMS studies on horizontal assembly line for ARIANE 6.
- Air Liquide : RAMS studies on tanks for ARIANE 6

POINT OF CONTACT

ADDRESS : 12 Avenue du Québec BP 636 Villebon sur Yvette
91965 COURTABOEUF CEDEX France

WEBSITE : www.sector-group.net

PHONE : +33 (0)1 69 59 27 27

POINT-OF-CONTACT : Guillaume de VERGIE, Responsable Commercial,
guillaume.devergie@sector-group.net, 01 69 59 27 30

TURNOVER : 8 000 k€

WORK FORCE : 100 employees

SPACE TURNOVER : 100 k€

SPACE WORK FORCE : 15 employees

Orbital systems
Launchers
Satellites
Ground segments
Balloons
Transversal competencies



SEGULA TECHNOLOGIES is an engineering group with a global presence helping boost competitiveness within all of the major industrial sectors: automotive, aerospace & defence, energy, life sciences, naval and rail.

COMPETENCIES & CAPABILITIES

Operating in more than 30 countries, with its 140 offices worldwide, the Group fosters a close relationship with its customers thanks to the expertise of its 12,000 employees.

A leading engineering specialist placing innovation at the heart of its strategy, SEGULA Technologies conducts large-scale projects, ranging from studies to industrialisation and production.

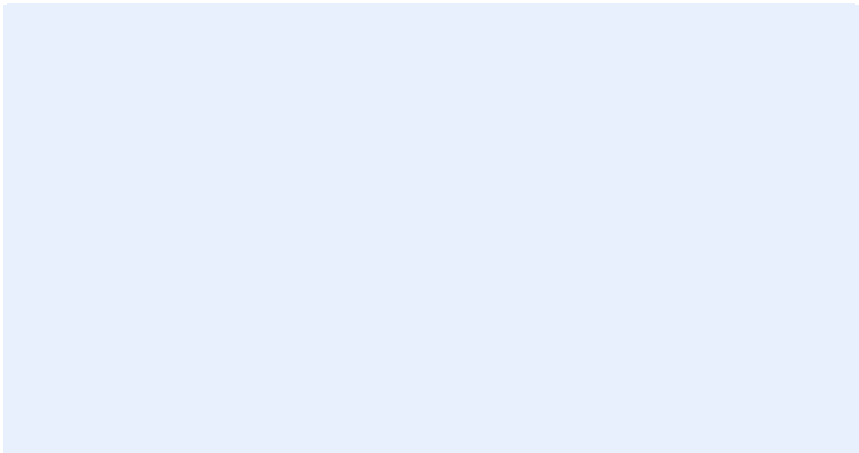

SEGULA TECHNOLOGIES

PRODUCTS & SERVICES

- ENGINEERING
- TOOLING
- PRODUCTION
- PRODUCTION SERVICES

MAJOR SPACE PROJECTS & REFERENCES

CNES, AIRBUS DS, THALES, CNIM

POINT OF CONTACT

ADDRESS 24 boulevard Déodat de Severac
31770 COLOMIERS France

WEBSITE www.segulatechnologies.com

MAIL : jacques.coriat@segula.fr

POINT-OF-CONTACT : CORIAT Jacques – Business Unit Director

TURNOVER

WORK FORCE 12 000 employees

SPACE TURNOVER

SPACE WORK FORCE

Satellites
Transversal competencies



Human-sized industrial group, Selha Group is specialized in industrialization and manufacturing of electronic products and test solutions. For more than 50 years, the group is a privileged partner of high-tech markets: aerospace, defence, telecom, energy, medical and industry.

With over 1000 employees, on 4 sites (in France & Morocco), Selha Group brings to its customers innovative solutions and the best quality level to make their projects successful.

COMPETENCIES & CAPABILITIES

- SMT Line: ISO 8 Certified / Coating Line: ISO 6 Certified
- Test Bench design & manufacturing, flying probe, ICT, Boundary Scan, Functional Test
- Laboratory for Electronics: X-ray inspection, cross section, fluorescence X...
- Industrialization & Engineering (DFX): DFC, DFP, DFM, DFT, DFA
- Clean room for optics: optical fiber, splicing, optical product integration & test
- PCBA, cabling, Sub assembly, system assembly



SELHA GROUP

PRODUCTS & SERVICES

EASYNDUS (DFX): Selha Group assists you from design phase with a single goal: the optimization of performance. These solutions will increase reliability of your product, accelerate time-to-market and reduce long-term costs.

EASYMANUF: Selha Group brings support at all stages of manufacturing, from prototype to wider production series. Expert in high mix–low volume (small series very diversified), the group produces electronic boards, cables, electronic and wired subassemblies, and full integrations with development of associated test solutions.

EASYSERVICES: During the product life cycle, Selha Group brings you solutions adapted to your needs: co-development, cobot, development and manufacturing of tests benches, electronic analysis lab...

EASYREPAIR: During the whole life cycle of your electronic equipment, Selha Group proposes solutions to ensure maintenance, repair and operations (MRO) to extend their lifetime.

MAJOR SPACE PROJECTS & REFERENCES

Syrlinks

OneWeb Satellites

AIRBUS Defense and Space

Thales Alenia Space

Expleo Group

Ariane Group (Sodern)

Nanowave

Ixblue

POINT OF CONTACT

ADDRESS 4 boulevard de l'Avenir – CS 40078
53800 Renazé France

WEBSITE www.selhagroup.com

PHONE +33 (0)2 43 09 14 30

POINT-OF-CONTACT: Pierre-Marie KERHERVE, *Business development manager*, pierre-marie.kerherve@selhagroup.com Phone: +33 (0)6 85 09 83 25

TURNOVER 100M €

WORK FORCE 1000 employees

SPACE TURNOVER 3 M€

SPACE WORK FORCE 30 employees

Launchers
Space planes
Transversal competencies

S.E.R.E.M.E.

SEREME is a leading Specialist in vibration, acoustic and micro-vibration test solutions, which drastically improve the quality of tests, homogeneity, cross talk, distortion.

SEREME is since 1976 an independent SME. SEREME R&D expenses represent 10% of its turnover.

COMPETENCIES & CAPABILITIES

- Design and delivery of turn-key test rigs and MGSE.
- Feasibility study of new test laboratories with their dedicated infrastructure.
- Upgrades of existing satellite ground test facilities.
- Versatile solutions for micro-vibration.
- Consulting services.



S.E.R.E.M.E

PRODUCTS & SERVICES

- Reverberating Acoustic Chambers (with air or nitrogen) for satellites and human rated spacecrafts.
- Self-cooled noise generators (LF, MF, HF) up to 175 dB (50 sets installed in France, China, Japan, Kazakhstan, Russia and South Korea).
- Small 4 DOF & 6 DOF vibration systems able to work up to 3000 Hz.
- Large light slip tables with OTM up to 1300kN.m.
- Vertical multishaker systems.
- MGSE (transport, Tvac, vibration adapters, test clamp bands, acoustic trolleys, antenna supports...).
- Micro-vibration measurement tables.
- Micro-vibration test solutions.
- Thermal Vacuum Chambers subsystems.

MAJOR SPACE PROJECTS & REFERENCES

- MGSE Galileo 2nd generation for Airbus GmbH.
- MGSE One Sat, Eurostar Neo, CSO, One Web, Astrobus SE... for Airbus D&S.
- 1000 M3 RAC for satellites: RKK Energia, Lavochkin, Kazakhstan (Airbus D&S/KGS), TAS Cannes (process design only).
- Versatile vibration isolation system for ESTEC for satellites up to 3.5 tons, compliant with Tvac conditions.
- ESTEC and KARI Quad-shakers systems & LST
- SbiK Kazakhstan medium size Tvac (with ALM).
- Customized vibration test device for Ariane 6, for Arianegroup Les Mureaux.
- Micro vibration tables for ESA-ESTEC
- Foundry mass suspended on air cushion for ESA-ESTEC

Airbus D&S, Arianegroup, BISEE (Cast), ESA ESTEC, ETS, GHALAM, IAI, Intespace, ISS Reshetnev, Jaxa, Kari, KGS, Lavochkin, RKK Energia and TAS are SEREME Customers in space industry.

POINT OF CONTACT

ADDRESS 31 rue Gutenberg – ZI la Marinière
91070 Bondoufle – France

WEBSITE www.sereme.com

PHONE +33 (0)1 60 86 42 36

POINT-OF-CONTACT : STEINBERG Max, Chairman, sereme@sereme.com,
+33 (0)1 60 86 42 36

TURNOVER 4 M€

WORK FORCE 20 employees

SPACE TURNOVER 4 M€

SPACE WORK FORCE 20 employees

Launchers
Satellites
Transversal competencies



SERMA MICROELECTRONICS provides microelectronics integration services to integrate semiconductors on substrates and hermetic or organic packages. Whether dice supply is needed or custom product delivered by the customers, a wide portfolio of potential solutions are proposed by SERMA MICROELECTRONICS to produce final good that can withstand harsh environment mission profile.

COMPETENCIES & CAPABILITIES

Process Engineering that defines the right microelectronics integration processes in order to industrialize products for customers.

Die Management managing the dice flows (supply, storage, wafer sawing, dice visual inspection).

Microelectronics production implementing the manufacturing & test processes to produce customers goods.

Thick film production defining and implementing screen-printing techniques to produce thick film substrates with high temperature resistance and service life.

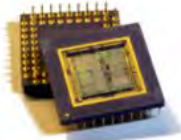

Single Chip Modules



MCM / Hybrids

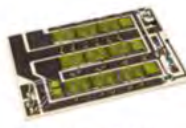

Power modules

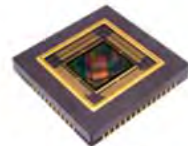
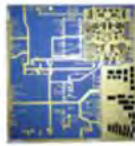

Image detectors



CCGA



Thick films



Enhanced plastic



Thin film

SERMA MICROELECTRONICS

PRODUCTS & SERVICES

The variety of processes available within SERMA MICROELECTRONICS allows addressing various markets and technologies. SERMA MICROELECTRONICS works on maintainability issues by maintaining robust process and securing their availability through time, and focus its R&D efforts on the development and deployment of technological bricks to integrate up-to-date technology (MEMS, High pin count devices, BGA) and mix its microelectronics means and SMT capabilities to integrate SiP (System in Package).

Special processes are also available such as COLUMN ATTACHMENT on LGA packages, this process being developed under ESA contract and validated by ESA for Flight Models production.

Our thick film manufacturing line is also qualified within THALES ALENIA SPACE BELGIUM PID for Flight Models production.

MAJOR SPACE PROJECTS & REFERENCES

LAUNCHERS :

ARIANE 4 / ARIANE 5 / ARIANE 6

SATELLITES :

ARABSAT / ARTEMIS / ENVISAT / GLOBALSTAR / HERSCHEL / INSAT / IRS / METEOSAT / METOP / PLANK / SPOT / HELIOS / SICRAL / TURCSAT / TARANIS / ROSETA / SVOM / JUICE / UVSQ--Sat / MTG / SES17 / KONNECT / KONNECT VHTS / IRIDIUM NEXT / ONEWEB

And several scientific programs.

POINT OF CONTACT

ADDRESS ZI Périgny, 34 avenue Joliot Curie
17185 Périgny Cedex France

WEBSITE www.serma-microelectronics.com

PHONE +33 (0)5 46 45 12 70

POINT-OF-CONTACT : BOUYSSI Lionel, Sales engineer,
l.bouyssi@serma.com, +33 (0)6 98 04 38 06

TURNOVER 12 M€

WORK FORCE 80 employees

SPACE TURNOVER Approx. 3 M€

SPACE WORK FORCE 80 employees

Orbital systems
Transversal competencies



SERMA TECHNOLOGIES is an **ESA-recommended laboratory** and provides customised support for each sector stakeholder:

- Space agencies and research laboratories
- Manufacturers of launch vehicles and satellites
- Equipment manufacturers, subcontractors
- EMS
- Component manufacturers
- Space and New space Primes Actors

COMPETENCIES & CAPABILITIES

SERMA Technologies provides its technological expertise when supplying EEE components by conducting destructive physical analyses, qualifications of components and assembly processes, upscreening, relifing, etc.

We monitor the manufacturing processes for components and circuit boards as well as materials used through PCBA verification and PCB inspection programmes.

SERMA addresses the specific needs of the procurement chain for a component by performing each stage from design to supply of an ASIC, by performing assembly and a customised test, or by qualifying COTS plastic components.

SERMA has also developed a specific knowledge in materials and surface science that is applied for the development of materials and new processes, production quality control, troubleshooting analyses and industrial expertise.



SERMA TECHNOLOGIES

PRODUCTS & SERVICES

Batch quality control for EEE components

- DPA (Destructive Physical Analysis), Construction analysis
- Failure analysis
- Counterfeiting inspection / Obsolescence management

Electrical testing & component qualification

- Electrical test engineering
- Screening, upscreening, relifing
- Post-Programming Test for FPGA components and other programmable components (PPT)
- LAT (Lot Acceptance Testing)
- Qualification of COTS (Components Off-The-Shelf) components
- Radiation Test / Ionics contamination

Materials & manufacturing processes

- PCB incoming inspection ECSS-Q-ST-70-60
- Verification program for circuit boards in accordance with ECSS-Q-ST-70-61
- Environmental testing, microsectioning
- Training / Justification document
- Failure Surface analysis on materials

MAJOR SPACE PROJECTS & REFERENCES

We are working for all the actors of the space industry:

- 3D PLUS
- AIRBUS DEFENSE AND SPACE
- ARQUIMEA
- BEYOND GRAVITY
- CNES
- COBHAM GAISLER
- CRISA
- EREMS
- ESA
- OHB
- SENER
- SODERN
- THALES ALENIA SPACE
- SYRLINKS

POINT OF CONTACT

ADDRESS 14 rue Galilée - CS 10055
33615 PESSAC Cedex France

WEBSITE <https://www.serma-technologies.com/en>

PHONE +33 (0)5 57 26 08 88

POINT-OF-CONTACT : ALFARO Clément , Space Area Manager
c.alfaro@serma.com, +33 (0)7 61 07 96 10

TURNOVER 26 M€

WORK FORCE 205

SPACE TURNOVER 5 M€

SPACE WORK FORCE 34

Orbital systems
Satellites
Transversal competencies



SHARE MY SPACE

Share My Space operates in the Space Situational Awareness market and is active in detection of artificial satellites and space debris, their tracking, cataloguing, and prediction of the collision risk. Our mission is to tackle the challenges related to space sustainability induced by the exponential increase of space debris and space traffic. We aim to propose a highly accurate and efficient new generation SSA platform, providing data and services. We also provide Space Sustainability Reports and mission planning studies.

COMPETENCIES & CAPABILITIES

To date, Share My Space has developed an ambitious strategy that will enable us to reach a turnover of nearly €45 million in 7 years and to establish a global presence.

It is based on the commercialization of a very innovative technology which uses optical means, and which will allow Share My Space to index more than 250 000 objects in orbit.

Moreover, due to the background of the team members, Share My Space has an expertise in plasma Physics, orbital dynamics, and satellite electric propulsion.

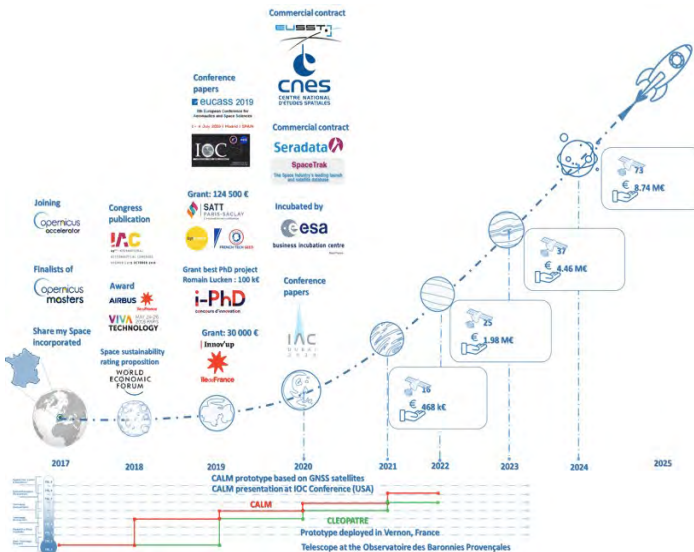

SHARE MY SPACE

PRODUCTS & SERVICES

Share My Space develops a complete range of products that occur at different parts of the satellite's life cycle. Firstly, we have INDEMN, a congestion simulation tool that occurs at the launch part. Then, CALM, is the space traffic manager software which is our core product, and satellite ID which is the grey card containing the history of the maneuvers and the risks of collision and debris positioning. Those ones take place during the operating period of the satellite, and later we have DRYADE for the debris removal. We also propose MANEXT, a set of algorithms used for maneuver detection and characterization, based on time series analysis of the TLE public catalog, and PADME, a technological project which consists in identifying the properties of the solar wind using deep learning methods that will be integrated on CALM software later.

We also offer some ancillary products: monthly reports and market insights, event intelligence and consulting, and Taylor made services, such as COLA for launchers and in orbit servicing.

MAJOR SPACE PROJECTS & REFERENCES

Share my space obtained a commercial contract with the CNES and Seradata in 2020 and plans to reach 468k€ within 2022.

The long term vision of Share My Space is to deploy a constellation of satellites that would capture targeted space debris to recycle them in orbit. Keeping this goal in mind, we have been committed in the Space Situational Awareness market since 2017. Within the framework of the SPACEWATCH project, patented technological solutions will be deployed and Share My Space will benefit from complete independence in terms of object catalog. With 250 000 objects, it will constitute the most complete database in the world.

POINT OF CONTACT

ADDRESS Share My Space La Turbine CS20001
32 Boulevard du Port 95032 Cergy Pontoise CEDEX France

WEBSITE www.sharemyspace.global

PHONE +33 (0)6 25 24 04 79

POINT-OF-CONTACT : Giolito, Damien, CEO

damien.giolito@sharemyspace.global, 06 25 24 04 79

TURNOVER

WORK FORCE

SPACE TURNOVER

SPACE WORK FORCE

Orbital systems
Satellites
Transversal competencies



Created in 1983, SILICOM is the oldest independent consulting company in France...

Dedicated to IT and Security concerns, technology and innovative challenges, SILICOM provides expertise to the major companies of Defense and Space, Bank and Insurance, Telecom, Transport, Energy and Industry areas.

COMPETENCIES & CAPABILITIES

In the Space Area, SILICOM is supporting its customers in R&D, industrialization, MOC phases:

- Ground system engineering and Satcom systems
- RF, transmission, signal processing, radionavigation, link budget, traffic and resources management
- Infrastructures, network, Cybersecurity
- System Simulation & performance
- Sector specific software: prototyping, development, integration and validation
- Scientific algorithms



SILICOM

PRODUCTS & SERVICES

SILICOM modes of intervention are both technical assistance and work package, as prime contractor or within service centers.

Our local management and organisation enable us to guarantee the success of projects either in-situ or ex-situ locations.

Silicom and its 'sister' Seela.io offer training based on the principle of "Tech Transfer". Our e-learning offer definitely fits the customer needs.

MAJOR SPACE PROJECTS & REFERENCES

SILICOM has been working for many years with the main space industrial players (Airbus Defense & Space, Thales Alenia Space, CNES...), contributing for major space systems (satellites payload, ground segment, performance tools...).

YAHSAT, IRIDIUM, GALILEO, EGNOS, SYRACUSE, ARGOS, RIFAN, 4G are some of the projects SILICOM has been part of.

POINT OF CONTACT

ADDRESS SILICOM SAS
Toulouse, France

WEBSITE www.silicom.fr

PHONE +33 (0)5 34 60 66 88

POINT-OF-CONTACT : MENARD Gilles, Toulouse Regional Manager
gmenard@silicom.fr 05 34 60 66 88

TURNOVER 17 M€

WORK FORCE 220

SPACE TURNOVER 3.2 M€

SPACE WORK FORCE 40

Satellites
Transversal competencies



SILIOS Technologies is a High-Tech French SME, specialized in micro-optics for diffractive optics and multispectral filters and sensors. Our two lines of products address the different application fields of Astronomy, Space & Defense, scientific, tooling and medical Lasers, Environmental surveillance, Bio-medical and Medical, Agriculture and Agro-food industries, Forensics and Security.

COMPETENCIES & CAPABILITIES

Competencies: Micro-optics design & manufacturing, mastering of micro-technologies processes in clean-room environment, optical design, diffractive optics and phase plates, custom multispectral filters design & manufacturing, assembly of multispectral and polarization filters onto pixelated sensors, custom multispectral sensors and cameras realization.
Capabilities: 600m² ISO 2-clean room, Filters assembly bench (hybridization), Multispectral sensors characterization bench, Multispectral filters characterization bench, Micro-technology process machines (Lithography, wet benches and RIE, sputtering etc..), Optical and dimensional tests equipment (Microscopes, Profilometers, spectrometers, etc...), Lasers and optical tables.

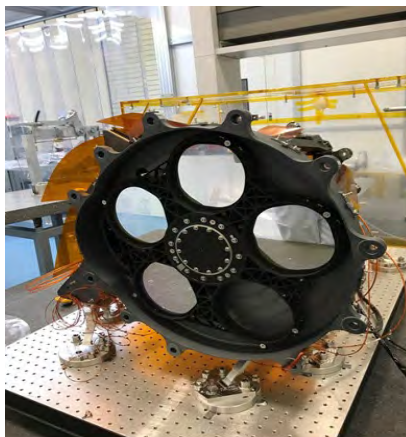

Grisms for NISP instrument (EUCLID Mission)

SILIOS Technologies

PRODUCTS & SERVICES

Products:

- Off-the-shelf multispectral VIS/NIR multispectral cameras. (1.3Mpix and 4.2 Mpix) cameras. (SWIR available Q1 2021).
- Custom multispectral filters and sensors
- Custom Gratings and Grisms
- Custom phase plates and diffractive optical elements. Beam shapers, homogenizers, mode converters, splitters, combiners, wavefront correctors, wavefront and aberrations generators, etc...

Services:

- Assembly of hyper/multispectral filters, crossed polarization filters onto various sensors.
- Optical design and micro-optics foundry services.

MAJOR SPACE PROJECTS & REFERENCES

- Large aperture NIR blazed transmission curved Grating on Prisms (GRISMS) for the NISP instrument of EUCLID Mission. (LAM)
- Continuously-Self Imaging Grating for characterization of space imagers (EUCLID Imagers). (ONERA)
- Diffractive phase plates for static aberrations generator (RASCASSE project) (Thales Alenia Space)
- 4 Mpix Snapshot Multispectral Sensors for Rashid-2 Lunar Rover (CNES)

POINT OF CONTACT

ADDRESS ZI PEYNIER-ROUSSET, Rue Gaston Imbert Prolongée
13790 PEYNIER France

WEBSITE www.silios.com

PHONE +33 (0)4 42 53 89 60

POINT-OF-CONTACT : BERTHOU, Thierry – Sales Manager
thierry.berthou@silios.fr - Phone: +33 677 71 83 71

TURNOVER 1,8 M€

WORK FORCE 10

SPACE TURNOVER 0.3 M€

SPACE WORK FORCE 3 - 5

Satellites
 Launchers
 Orbital systems
 Transversal competencies



SMAC team is your partner for pyroshock, acoustic load, micro-vibration and sealing purposes

For more than 25-years, SMAC continues to expand its reputation of being a leading partner in the development, manufacturing and testing of innovative viscoelastic solutions for sealing and shock & vibration control for the international space sector. Each and every day, we pride ourselves on exceeding the expectation of our customers by offering the highest level of expertise in the field of protecting sensitive equipment and systems exposed to harsh environments, enabling our partners to focus on mission success.

COMPETENCIES & CAPABILITIES

Flight proven innovative solutions

- ESA-qualified damping viscoelastic materials,
- Vibration and micro-vibration isolation for optical instrument, cryocooler, inertial measurement unit, reaction wheel,
- Shock and pyroshock cancellation for payload protection, on-board electronic, pyrotechnic equipment,
- High performance sealing solutions,
- Build-to-spec & Build-to-print projects,
- On-site production tool, mixing and precision molding,
- On-site environmental testing laboratory,
- Quality certification AS9100:D/JISQ9100:2016/EN9100:2018

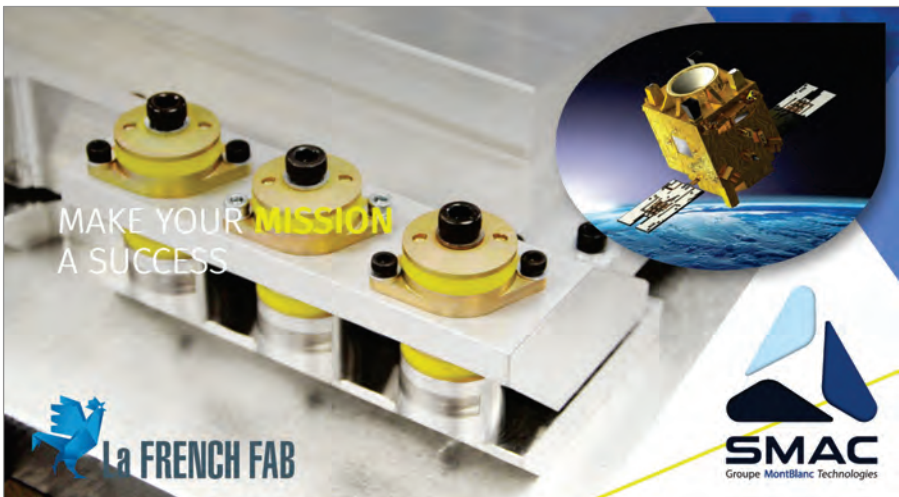

SMAC

PRODUCTS & SERVICES

Standard and custom solutions for satellites and launchers

- Vibration isolator,
- Micro-vibration isolator,
- Shock attenuator,
- Pyroshock attenuator,
- Dynamic absorber (Tuned mass damper),
- Damped strut,
- Structural damping tile,
- Acoustic insulation materials,
- High performance sealing parts,
- Innovative elastomer-piezoelectric hybrid solutions,
- Hybrid solutions with elastomer and composite materials or metal for better stability and precision in thermal environment,
- Environmental testing : combined vibration and thermal (sine, random), shock and micro-vibration,
- Collaborative project management.

MAJOR SPACE PROJECTS & REFERENCES

SMAC team has a large experience in space projects with its international customers :

- AIRBUS D&S
- ARIANEGROUP
- AVIO
- BOEING D&S
- CNES
- ESA
- IXBLUE
- MDA
- NAMMO
- NANO AVIONICS
- OHB
- RUAG AEROSPACE
- SAFRAN E&D
- SAFT BATTERIES
- SENER
- SSTL
- TESAT
- THALES ALENIA SPACE

POINT OF CONTACT

ADDRESS ZI Toulon Est - BP 119 - 83079 TOULON Cedex 9 - FRANCE

WEBSITE www.smac-sas.com

PHONE +33 (0) 494 752 488

POINT-OF-CONTACT :  FrédéricIVALDI - frederic.ivaldi@smac.fr

POINT-OF-CONTACT :  Jean-MarcHERZEL - jean-marc.herzel@smac.fr

TURNOVER 7 M€

WORK FORCE 50 employees

SPACE TURNOVER 2 M€

SPACE WORK FORCE 15 employees

Satellites
Transversal competencies



Sodern is specialized in the design and manufacture of neutron, optical and space instruments. Since its inception in 1962, the company develops cutting-edge technologies and provides innovative, world-class solutions. Sodern is the market number one supplier of star trackers and a recognized global specialist in neutron analysis. Sodern is enabling your ambitions.

COMPETENCIES & CAPABILITIES

Design, production and sale of:

- Space instrumentation,
- Attitude measurement,
- Optical Instrumentation,
- Neutron Analysis System.
- 330 employees, amongst which 60% of engineers and technicians
- 8,300 sqm of laboratories and production facilities, including 1,800 sqm of clean rooms

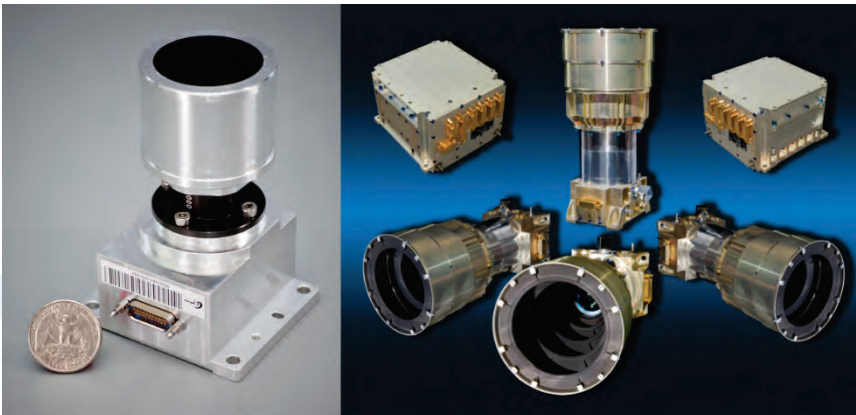

SODERN

PRODUCTS & SERVICES

- Star Trackers
- Space Cameras
- Spectrometers
- Scrambling Windows
- Stripe Filters
- Focal Plane Arrays
- Rendez-Vous Sensors
- Optical Switches
- Optical Ground Support Equipment
- Optical Bench
- Laser sources Modules for Space
- Optical Beam Shaping/Steering
- FastGrade™ Mineral Probe

MAJOR SPACE PROJECTS & REFERENCES

- Auriga Star Tracker for OneWeb
- Hydra Star Tracker
- Star Tracker for Europe Clipper (NASA)
- NAVCAM Navigation Camera for JUICE (ESA)
- SEIS seismometer for InSight (NASA)
- IASI Camera and laser source for METOP (ESA)
- Beam Extender EBEX and Beam Steerer BSA for EarthCARE (ESA/JAXA)
- OLCI-COSA Spectrometer for Sentinel 3 (ESA)
- TARANIS Camera (CNES)
- UV2VIS Spectrometer for Sentinel 5 (ESA)
- Pharao Laser source and tube (CNES)
- Laser Unit for MTG (ESA)

POINT OF CONTACT

ADDRESS 20 avenue Descartes - BP 23
F-94451 - Limeil-Brevannes - Cedex - France

WEBSITE www.sodern.com

PHONE +33 (0)1 45 95 70 00

POINT-OF-CONTACT Véronique SEGUIN
Marketing, Sales & Communications Director

TURNOVER €73m

WORK FORCE 450

SPACE TURNOVER €50m

SPACE WORK FORCE 250

Orbital systems
Satellites
Transversal competencies

Soditech

DESIGN, ASSEMBLY AND INTEGRATION OF MLI,
HARNESS, STRUCTURE

COMPETENCIES & CAPABILITIES

Soditech is a SME specialised in the integration of mechanical, thermal and electronic subsystems for Space, Research and Defence. For 30 years, Soditech has been providing the largest industrial groups with a complete offer that enables it to take full responsibility for projects from specification to integration.



SODITECH

PRODUCTS & SERVICES

Thermal hardware
DC Harness and EGSE
Mechanical assembly

Design, manufacturing and integration
ISO8 and ISO5 Clean rooms
Physico-chemical laboratory

MAJOR SPACE PROJECTS & REFERENCES

Telecoms: Arabsat, Nahuel, Sinosat, Syracuse 3, Turksat, SWA, Hispasat, W3B, W3c, Eurasiasat, Astra 1K, Sirius, Thaicom, Eutelsat, W24, GE1, GE2, Ciel, X11, X13, Rascom, Nilsalt, Hotbird 6, HB7, Sesat, Galaxy 17, Galaxy 12, Europe Star, Palapa D, AMOS5, GE Americom, TKM, Chinasat CH9, Yamal, Alphabus, E8WB, Koreasat 7, K5A, SGDC, IEH,T3S, BS1,...

Telecom Constellations : 24 models of Globalstar 2 PF panels harnesses and MLI , 20 models of O3B PF panels harnesses, 80 tank heating systems for Iridium...

Earth Observation and Scientific : Vegetation, Meteosat, Spot5, Helios, Meteosat Second G, ATLID LRA, Tropomi, SWOT, ISO, IASI, Proteus/Jason, Stentor, CoRot, Cassini/Huygens, Artemis, Norsat, Euclid, Solar Orbiter, FLEX

POINT OF CONTACT

ADDRESS 1 bis Allée des Gabians
06150 Cannes la Bocca France

WEBSITE www.soditech.com

PHONE +33 (0)4 92 19 48 00

POINT-OF-CONTACT : CAILLE Madenn, Managing Director
madenn.caille@soditech.com - +33 (0)6 82 78 32 95

TURNOVER 6 M€

WORK FORCE 75

SPACE TURNOVER 3,9 M€

SPACE WORK FORCE 50

Orbital systems
 Launchers
 Satellites
 Transversal competencies



Sogeclair aerospace is an international leader in high-tech engineering based in France, Germany, Spain, UK, Tunisia and Canada.

Sogeclair aerospace provides a wide range of competences in design, analysis & simulation, integration, certification support, manufacturing in the Aeronautic, Space and Transportation industry, for civil and defense markets.

COMPETENCIES & CAPABILITIES

Our know-how and skills in the space sector (Launcher and Satellite) are articulated around:

- Mechanical Design & Analysis
- Thermal management
- Mission Analysis
- Coupled Load Analysis
- Flight Exploitation
- Software Development
- Test prediction and Follow-up
- Additive Manufacturing (Topologic optimization, Design and Build, ...)
- Configuration and Export control Management



SOGECLAIR AEROSPACE

PRODUCTS & SERVICES

Sogeclair aerospace provides engineering expertise in the aeronautics and space sector in many competences/fields such as:

- Engineering services new and serial products
- In-service repair and overhaul
- Satellite and launchers engineering
- Aerostructure design & build
- Electro-mechanical flight controls equipment
- Aircraft interiors design & build

Moreover, Sogeclair aerospace has developed a new branch: Products grouping together all of our “Design and Build” offers with innovative technologies and materials such as Thermoplastics, Additive Manufacturing.

MAJOR SPACE PROJECTS & REFERENCES

Our main customers in the space field: CNES, Airbus Defense and Space, ArianeGroup, Arianespace, Thales Alenia Space.

Our main projects are:

Project Mission analysis for ARIANE, SOYUZ and VEGA

- *Dynamic (CLA), Mechanical, Thermal, Trajectory analysis & Software development*

Project Prometheus: Heat exchanger (ArianeGroup)

- *Industrialization study, Mechanical Engineering*

Project CALLISTO (CNES)

- *Mechanical design, Dynamic and Aeroelastic calculation*

Project: Telecom and Scientific Satellite (Airbus Defense & Space)

- *Software and System configuration management*
- *Export control*

POINT OF CONTACT

ADDRESS 7 Avenue Albert Durand
31700 Toulouse France

WEBSITE www.sogeclair.com

PHONE +33 (0)5 61 71 70 00

POINT-OF-CONTACT : sales@sogeclairaerospace.com

TURNOVER 185 M€ (2019)

WORK FORCE 1651 employees

SPACE TURNOVER 4.9 M€ (2019)

SPACE WORK FORCE > 50 employees

Launchers
Transversal competencies



Sokaris is specialized in optimization, modeling and simulation of structural components ready for industrialization that will offer competitive price and optimal mass reduction. Our engineering office has the certification CIR (crédit impôt recherche) and it is composed of 3 main activities:

- **Mechanical engineering**
- **Software tool engineering**
- **Research & Technological innovation**

COMPETENCIES & CAPABILITIES

Our engineering office provides global solutions PRODUCT/PROCESS by offering technical support to its customers starting from specifications to industrialization for a component or a system.

Sokaris has expertise with multi-materials projects, various manufacturing processes and technologies for assembly.

Processes: Die casting, forging, thermoplastic injection, thermoforming, stamping, additive manufacturing (polymer and metallic).

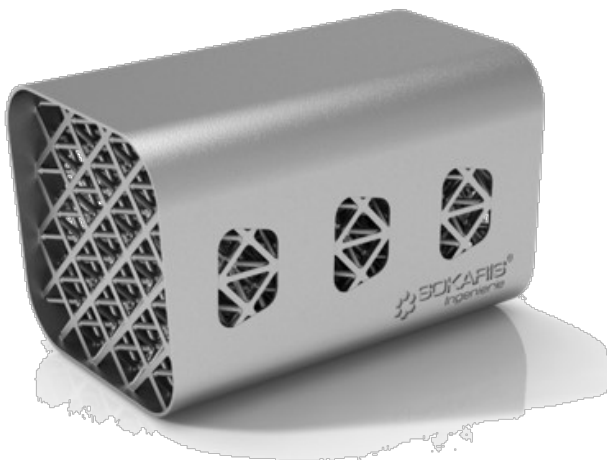

SOKARIS INGENIERIE

PRODUCTS & SERVICES

- **SERVICES**

Mechanical Engineering

System architecture design.
Design, Topological and Shape Optimization.
Modeling, simulation and process simulation.

Software tool Engineering

Development of specific software tools that reduce costs and development time.
Pre-sales support, training, deployment & maintenance.

Research & Technological Innovation

Development of methodologies for design, optimization and calculation.
Development of software tools dedicated to customers.
Materials and characterization → Alloy, Steel, Nickel, Polymer and Elastomer.

- **PRODUCTS**

Development of systems with high efficiency absorption thanks to plastic deformation.
Development of hybrid structures.
Optimization and manufacturing of inertial measurement unit in additive manufacturing.
Optimization of components and aeronautical systems.

MAJOR SPACE PROJECTS & REFERENCES

Challenge R&D Lanceurs du CNES

Sokaris has been rewarded by CNES in 2020. Our company offered an innovative technology regarding shock absorption system with high efficiency.

Collaborative project PALOMA (in collaboration with Ariane Group)

Sokaris is the leader of WP T5000 that focuses on the integration of the constraints of additive manufacturing process in topological optimization.

References

CNES, Ariane Group, Avio, Safran Group, UTC Technologie, MBDA, PSA, RENAULT, Faurecia, Vibracoustic
Merck, Carrier, NTN-SNR

POINT OF CONTACT

ADDRESS 2, rue George Sand – Fourqueux

78112 SAINT GERMAIN EN LAYE - FRANCE

WEBSITE www.sokaris-ingenierie.com

PHONE +33 (0)1 39 10 80 36

POINT-OF-CONTACT : communication@sokaris-ingenierie.fr

TURNOVER 1,1 M€

WORK FORCE 12

SPACE TURNOVER 265 K€

SPACE WORK FORCE 3

Orbital systems
Transversal competencies



Subsidiary of APAVE Group, SOPEMEA is composed of 7 entities and 1 training organization specialized in environmental qualification of equipment, EMC expertise, safety and electric products conformity. SOPEMEA's French laboratories are CIR, CII and COFRAC or UKAS accredited.

With a team reaching more than 200 persons, SOPEMEA Group is located in the area of Paris, Lyon, Grenoble, Valenciennes, and in Toulouse in France; and in Bideford, UK.

COMPETENCIES & CAPABILITIES

EMC support for the qualification of equipment or systems:

Writing test procedures and test reports / Performing EMC tests / Monitoring of EMC qualification / Design consultancy and assistance in solving EMC and electronic problems.

Technical assistance (digital simulation):

Analysis of the system and the initial digital model (CAD) / Request to the design office for CAD update / Construction of the digital model for 3D/1D co-simulation / Definition of the matrix of calculation cases / Analysis of calculation results and definition of an optimal configuration / Consolidation of the methodology to be applied based on the input data and expected results / Writing of the analysis report.

Essais CEM - Normes européennes

- EN 55032-32-30-37C
- MIL-STD-461
- Specifications GRES/THALES/Avia/UKAS

Salle propre ISO 7 (classe 10 000)

Special coating

Antistatic PVC slats

ESSAIS EN ZONE PROPRE

Salle propre mobile

ERTAS/ER/AVION/SHIPT/RE/RSI/AVIA/UKAS

ThalesAlenia Space | Syrlinks | SAFRAN | EREMS | Bertin | CNES

SOPEMEA

PRODUCTS & SERVICES

For over 70 years, SOPEMEA has offered its customers a full range of support and testing services to test all types of equipment in the mechanical, climatic, electrical, hydraulic and electromagnetic compatibility fields, CE marking and measurements on site. SOPEMEA covers the Aeronautics, Space, Defense, Rail, Energy and Nuclear, Automotive, Medical and consumer industrial equipment markets.

Sopemea offers its support from the elaboration of your test strategy to the final qualification of your equipment. Sopemea also offers training in line with your tests.

Sopemea offers a wide range of services to ensure operational readiness of your test equipment, from the most traditional to the most complex.

Among our references: Airbus, Alstom, ARQUUS, BERTIN, CNES, EDF, LIEBHERR, MBDA, Safran, Nexter, Framatome, RATP, Renault-Nissan, STEEL Electronique, Syrlinks, Thales.

MAJOR SPACE PROJECTS & REFERENCES

SOPEMEA worked on the following space projects:

- Solar-Orbiter (Erems)
- Myriade-Evolution (Syrlinks, Bertin, Erems)
- INSIGHT (CNES/JPL)
- ANGELS / X-IFU / Ballon BPS (CNES)
- SUPERCAM (IRAP CNRS)
- TARANIS (Bertin)
- ARGOS 4 (Steel Electronique & Syrlinks)
- Satellites de télécommunication (Egypt Milsatcom, ...)
- ALEXANDRITE (Syrlinks)
- OBC MICROCARB (Steel Electronique)
- SWFS (BertinTechnologies)
- DOCON, MILCOMSTAR, UPCONV YENISEI (Thales Alenia Space)

POINT OF CONTACT

ADDRESS 1 rond-point du Général Eisenhower
31100 Toulouse France

WEBSITE www.sopemea.fr

PHONE +33 (0)5 82 52 82 00

POINT-OF-CONTACT: ADJEMIAN, Florence, Business Engineer
adjemian@sopemea.fr, +33 (0)762 373 706

TURNOVER 21 M€

WORK FORCE 206

SPACE TURNOVER 0.6 M€

SPACE WORK FORCE 30

- Orbital systems
- Launchers
- Satellites
- Ground segments
- Balloons
- Transversal competencies



SOPHIA ENGINEERING, member of GIFAS and of the Space Commission, based at SOPHIA ANTIPOLIS, employs 250 people, including 230 in France and generated a turnover of € 19.9M in 2020.

Sophia Engineering is well-known both for speeding up innovation and for its technology transfer skills and offers a link between research and industry.

Sophia is an engineering service specialist and offers disruptive economic, managerial and technological models. Sophia develop and deliver customed, compact, light and efficient optical payloads dedicated for Earth observation.

COMPETENCIES & CAPABILITIES

The strengths of SOPHIA ENGINEERING are:

- Its R&D and Innovation strategy for Optical and Optronics systems: development and investment for 14 years in its know-how and organization
- Its culture, know-how, technological knowledge and multi-sectoral methodologies: interconnections and technological transfers of optical and optronic technological bricks
- The efficiency of its organization to deliver systems in a short time and at a lower cost
- His knowledge of the various players in the innovative ecosystem (Large Groups, Mid-sized Companies, SMEs, Start-ups, public laboratories, National or European institutional bodies, national groups): relational mastery in co-innovation consortia and multi-technological vision. sectoral
- Knowledge of the entire production cycle of a product: management of the integration phase and consortium production (production experience of series of 30,000 copies)



SOPHIA ENGINEERING

PRODUCTS & SERVICES

Structured as an integrator of Technological Solutions, Sophia's organization makes it possible to take charge of the identification, design, development and qualification of proofs of concept (POC), their integration into a technological demonstrator and the delivery of the final systems while favoring transfers of technological bricks directed towards space, defense, security, medical, automotive and aeronautical applications.

MAJOR SPACE PROJECTS & REFERENCES

In the space sector, since the beginning of Sophia's history, we have been involved in all phases of a project, from upstream studies to Assembly, Integration and Testing.

We have worked on more than 30 space missions. For the nanosat industry, we are developing solutions that are compact, light, efficient and quick to implement.

We develop and deliver observation payloads.

EUCLID, ELECTRA, SKYLARK, TARANIS, MICROCARB, HREO, ESPRIT, CO2M, SEOSAT, TANGO, OLCI Sentinel 3, MTG, Darwin...

POINT OF CONTACT

ADDRESS 5 rue Soutrane
06560 Sophia Antipolis France

WEBSITE www.sophiaengineering.com

PHONE +33 (0)970 820 250

POINT-OF-CONTACT : Vincent DAVID, CEO
communication@sophiaengineering.com

TURNOVER 19,9 M€

WORK FORCE 250 employees

SPACE TURNOVER 4 M€

SPACE WORK FORCE 50 employees

Orbital systems
Satellites
Ground segments
Transversal competencies



Created in 1975, SOTEREM historical activity is the manufacturing of experimental devices dedicated to nuclear research reactors (CEA).

The company activity grew up rapidly toward other hi-tech industrial sectors such as space onboard experimental payloads and specific high technology equipment designed upon customer specification.

SOTEREM is EN 9100 certified since 2007.

COMPETENCIES & CAPABILITIES

Mechanical & material engineering

- High precision mechanisms
- High temperature material & device
- Exotic welding and brazing
- Rotating machinery for on board air conditioning
- On board electro-mechanical actuators

Vacuum, pressure and thermal engineering

- High temp thermal analysis
- High vacuum and high pressure equipment

Production Resources: Conventional machine shop, TIG/MIG orbital welding, Vacuum induction brazing furnace, glove box for vacuum/ rare gaze welding, clean room 10,000.



SOTEREM

PRODUCTS & SERVICES

Space on board equipment:

- Experimental payload for microgravity experiences: Furnaces and cartridges.
- Environmental control and life support system (ECLSS) equipment: fan and water separator for International Space Station (ISS).
- Micro satellite and payload AIT.
- Electrical motor: brushless, sealed, steppers etc... and actuators

Nuclear, Aeronautics Industry and defence,

- Furnace and instrumented experimental devices for material irradiation, Sodium loop, various thermal and fluid loops,
- Electromechanisms for nuclear research reactors,
- Actuators and electro mechanisms.

Ground station:

- Pursuit antenna pedestal
- Ground support mechanical and electrical test bench.

MAJOR SPACE PROJECTS & REFERENCES

Furnace for ISS Columbus module (AIRBUS DS/ ESA)

- LGF & SQF furnace for "Material Science Laboratory"
- Experimental cartridges for "Material Science Laboratory"

ISS ECLSS for Columbus module (AIRBUS DS/ESA):

- Cabin fan assembly and condensed water separator assembly
- Mechanical Designs and MAIT activities for ACLS loop

Space Motors: CMG motors (AIRBUS DS), Sealed brush motor (ESA) and DC brushless motor Saphir (CNES), High Detent torque stepper motor (ESA) Satellite AIT: DEMETER, PARASOL, PICARD, MICROSCOPE, TARANIS, ARGOS (OCEANSAT).

Resetable & ultra-low shock actuator: on-going developements.

POINT OF CONTACT

ADDRESS 5 rue de la technique, ZI de VIC

F-31322 - Castanet-Tolosan - France

WEBSITE www.soterem.fr

PHONE +33 (0)5 62 71 90 60

POINT-OF-CONTACT :

philippe.mascunano@soterem.fr / xavier.isnard@soterem.fr

corine.lacoste@soterem.fr / alexandre.lagriffoul@soterem.fr

TURNOVER > €8-9m

WORK FORCE 60

SPACE TURNOVER €5m

SPACE WORK FORCE 25

Satellites
 Balloons
 Transversal competencies



SOTREM SEO

Since 1996, we have specialized in the design, production and integration of electrical and electronic systems for the aeronautics, defense, space and energy sectors.

We support major industrial groups in the realization of their projects.

Today Sotrem SEO has become a leading player in the wired cabling and card cabling.

COMPETENCIES & CAPABILITIES

Competencies:

- Ground & Flight Harnesses
- Card Conception & Wiring (including Parallel Gap Welding, Drying oven, ...)
- Test & Control (electronic sub-assemblies and systems; Temperature environmental test chambers)
- EGSE integration

Capabilities:

- Equipped and ISO 8 Certified Clean Room (+350m²)
- Highly skilled and experienced operators accredited to IPC Standard



SOTREM SEO

PRODUCTS & SERVICES

With proven experience, our teams advise and guide clients throughout the collaboration. They are involved in every step of the project:

- Design,
- Manufacture,
- Integration,
- Testing,

but also provide:

- Documentation,
- On-site installation,
- Training (IPC Standard),
- Technical Support and Maintenance.

SOTREM SEO has more than 75 employees with complementary skills - engineers, technicians, wiring specialist - who work in perfect synergy to provide quality work and meet the objectives set with the client.

MAJOR SPACE PROJECTS & REFERENCES

- OneWeb Satellites: EGSE Integration
- Airbus Defence & Space: Test-Aid, Ground & Flight Harnesses, Rooting, Wiring Connectors, Thermistors, Heater
- Thales Alenia Space: RF Card wiring & Control
- Others customers: Captive Balloons, Solar Cell assembly, ...

POINT OF CONTACT

ADDRESS 7 Avenue Yves Brunaud
31770 Colomiers France

WEBSITE www.sotrem.com

PHONE +33 (0)5 61 15 34 00

POINT-OF-CONTACT: ROUMEGOUX Pierre, Space Sales within SOTREM SEO
proumegoux@sotrem.com, +33(0)6 30 01 39 45

TURNOVER 4,4 M€ (2020)

WORK FORCE 75 employees

SPACE TURNOVER 0,5 M€

SPACE WORK FORCE 6 employees

- Orbital systems
- Launchers
- Satellites
- Ground segments
- Balloons
- Transversal competencies



Spacebel is a Space systems and software engineering SME operating in the Space and Earth monitoring application sectors, serving space agencies, major aerospace prime companies, EU institutions and the commercial market. We are active in several domains, mainly Earth Observation, Space flight and science, but also telecoms, navigation, exploration, launchers, balloons and space situational awareness.

COMPETENCIES & CAPABILITIES

Our skills include the mission definition and analysis of EO minisatellites, design, development, integration, validation of IT space systems and geospatial information systems:

- Earth observation spacecraft and complete Earth Observation solutions including user requirements and system definition
- On-board control and data handling software for satellites & space vehicles
- Satellite simulation tools
- Ground systems for control and mission centers
- EO WEB services provisioning infrastructures
- Geospatial information systems support and services



SPACEBEL

PRODUCTS & SERVICES

SPACEBEL is a recognised developer of System Modelling and Simulation products for the satellites and probes segment, the launchers segment, the orbital transportation systems and the ground segment. Since 1994, SPACEBEL is active in the area of tests and simulation and has become a leading company in Europe in that domain. Its Modelling & Simulation Business Unit addresses most of the related technology domains such as satellite operational simulators for mission control, software validation facilities, numerical modelling of space environment, emulators of on-board processors (e.g. 1750, Erc32, Leon, Arm) and much more.

MAJOR SPACE PROJECTS & REFERENCES

Simulation modelling platforms make part of our expertise and address most relevant standards such as Simulation Model Portability SMP2 and the ECSS E40-07 SMP from the European Cooperation for Space Standardization. SPACEBEL is the developer of the CNES Agency's simulation platform namely BASILES and VTS products. Additional mission operations tools are also available for Telemetry/Telecommand and data decoding: PrestoTools (amongst other PrestoPlot®). SPACEBEL has also an outstanding experience with other simulation modelling frameworks such as Matlab/Simulink (Mathworks), SIMSAT (ESA), EuroSim (Airbus DS) and SimTG (Airbus DS). We have delivered simulators for a number of successful ESA and CNES missions such as Proteus, Proba, Hera, Pleiades, Cso, Ceres, Swot, Svom, Metop-sg, Euclid, Mtg, Altius and much more...

POINT OF CONTACT

ADDRESS Technoparc 8 – rue Jean Bart
31670 Labège - France

WEBSITE www.spacebel.com

PHONE +33 (0)5 32 09 09 09

POINT-OF-CONTACT : info@spacebel.fr

TURNOVER 2 469 600.00 € (2020)

WORK FORCE 25 employees

SPACE TURNOVER 2 469 600.00 € (2020)

SPACE WORK FORCE 25 employees

Ground segments
Launchers



SpaceDreamS is a spaceport architect company.

Based on a modular and interoperable concept, we design, develops and operates tests benches & spaceports.

COMPETENCIES & CAPABILITIES

- Prospective studies / High Level Requirements specification
- Spaceports design
- Control benches for launchers
- Launcher operations on ground
- Cryogenic & fluidic design and operations
- High reliability technologies
- Risk analyses



SpaceDreamS

PRODUCTS & SERVICES

SpaceDreamS develops the NuPad, an universal, mobile, interoperable, multisite & multilaunchers launchpad composed by 3 main batches:

- Ground segment “boxes” launchers services (LOXBox, Methanebox, ElectricalBox, ACbox, ComBox, ...)
- Control Command / Ground Operation Control process
- TwinPad / Digital twin of our solution

SpaceDreamS supports institutions, spaceports and launchers companies to define ground activities with an end-to-end vision; High Level Requirement, Design activities, virtual & on-site commissioning, serial operations, products & processes evolutions, dismantling...

MAJOR SPACE PROJECTS & REFERENCES

ESA – Various prospective studies

European Commission / Eu-BEST (European Bench for Engine Serial Tests)

ArianeGroup – VOLARE project

CNES – Coactivity Study of Diamant Launch Base

HyPrSpace – TERMINATOR Project (LOXBox & Launcher Mock-up for scale 1 engine test)

POINT OF CONTACT

ADDRESS 20, rue Ampère – 91300 MASSY
31, allées Jules Guesde – 31000 Toulouse

WEBSITE www.spacedreams.com

PHONE +33 (0)6 14 59 17 10 / +33 (0)6 46 45 70 43

POINT-OF-CONTACT : CANART Christian - CEO / FACHIN Gilles - COO

TURNOVER < 1 M€

WORK FORCE 10 employees

SPACE TURNOVER < 1 M€

SPACE WORK FORCE 10 employees

Orbital systems
 Transversal competencies
 Ground segments



SpaceLocker develops sustainable & shared space missions.

Our payload hosting services will transform expendable satellite platforms into reusable space infrastructure while enabling the development of platform agnostic payloads.

COMPETENCIES & CAPABILITIES

At SpaceLocker, we can host any type of payload on numerous satellite platforms.

Thanks to our interface technology that holds launches and enable mechanical, thermal, electrical and data coupling between payloads & platforms, we can provide a seamless access to space without having to build dedicated satellites.

Our advanced data management system combined to our universal interface enables to develop payloads regardless the platform they will fly with and to directly direct collected data in a cloud data system.

As our system is made to be plug-and-play directly in orbit, the platforms adapted will become reusable and upgradable as soon as in-orbit servicing will become available.



Product

Space Missions as a Service

CONFIDENTIAL - All rights reserved © SpaceLocker 2023



01
 Clients build their payloads



02
 SpaceLocker plug them on a host satellite



03
 Host satellite is launched



04
 SpaceLocker operates the satellite



05
 Clients place operation orders & gather data

SpaceLocker

PRODUCTS & SERVICES

We provide hosting services for payloads of less than 200kg flying on any orbit as long as they fit one of the available launch opportunities provided on our website (www.spacelocker.fr).

This covers flight opportunities on various orbits, mainly LEO as a start but tomorrow GEO or even lunar orbits should be added to the catalog.

Hosting vehicles can be dedicated platforms bought by SpaceLocker for shared missions or third-party missions hosting secondary payloads.

MAJOR SPACE PROJECTS & REFERENCES

- First mission targeted for the end of 2024: "Out Of The Box" a shared 12U CubeSat with 4 clients onboard.
- SmallSat mission targeted in 2025 with around 50kg of payload
- CNES Contract: "Sustainable space study"
- Member of the Space Business Catalyst by Thales Alenia Space
- Member of ESA BIC Nord France

POINT OF CONTACT

ADDRESS 26 Av. Jean François Champollion,
31100 Toulouse, France

WEBSITE www.spacelocker.fr

PHONE +33 (0)6 60 38 24 54

POINT-OF-CONTACT : Theophile LAGRAULET, CEO, contact@spacelocker.fr

TURNOVER ~0.5 M€

WORK FORCE 6

SPACE TURNOVER 100%

SPACE WORK FORCE 6

Orbital systems
Satellites
Transversal competencies



SPACEPHARMA

Development and exploitation of spaceborne remotely controlled miniaturized laboratories for research and development in life sciences, and for production of innovative health products in microgravity.

COMPETENCIES & CAPABILITIES

Development and Operations of Miniaturized space laboratories.
Exploitation of life sciences data from space experiments.

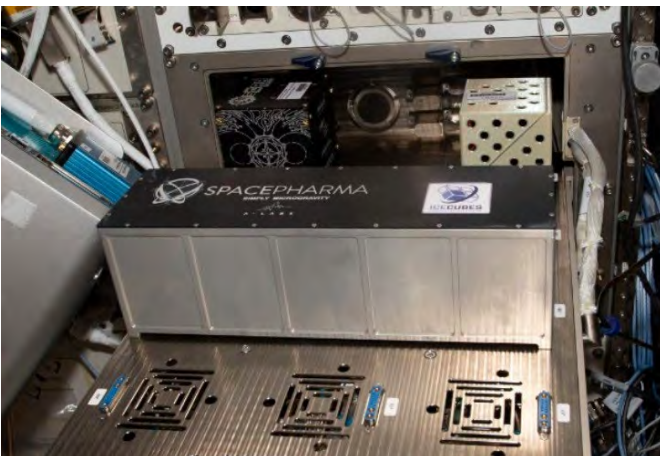

SpacePharma-EU

PRODUCTS & SERVICES

Innovative miniaturized remotely controlled microfluidics chemistry/biology laboratory on Nanosatellites and space station payload to perform R&D, manufacturing, shorten time-to-market and cut costs for innovative life science applications. SpacePharma provides low cost one-stop-shop end-to-end turnkey upstream, downstream and analytics solution, including:

In-Orbit Facility (research, development, production).

Ground station for remotely laboratory control.

Customer front-end allowing customers to monitor, develop and modify the experiment procedures and receive experimental data from their location on Smartphones.

Return to Earth if needed.

MAJOR SPACE PROJECTS & REFERENCES

After a successful experiment demonstrated in parabolic flight in 2016, SpacePharma has launched two Nanosatellites (“DIDO” missions) with full success. Another lab has been deployed seven times onboard the ISS– that didn’t require any Astronauts’ operation after setting the lab in place. These deployment methods opened a new era that is meeting the above-mentioned needs while closing the gaps with high User-Friendly End-To-End solution.

Nine space missions accomplished to date, 2 flights with lab on-board DIDO nanosatellite, 7 flights on the International Space Station.

Total of 36 customers.

POINT OF CONTACT

ADDRESS 1 Rue Jean-Dominique Cassini
67400 Illkirch-Graffenstaden, France

WEBSITE www.spacepharma.health

PHONE +33 (0)6 07 18 91 03

POINT-OF-CONTACT : Kamoun, Paul, Managing Director

kamoun.paul@spacepharma.health, 00 33 6 07 18 91 03

TURNOVER 1 M€

WORK FORCE 3

SPACE TURNOVER 1 M€

SPACE WORK FORCE 3

Transversal competencies
Orbital systems
Ground segments
Balloons



SPARTAN SPACE is developing habitation systems for extreme environments and human spaceflight.

The company also develops equipment for ergonomic tests and analogue trials for human and robotic spaceflight.

COMPETENCIES & CAPABILITIES

Engineering support in the fields of human spaceflight and robotic space exploration:

- Habitation systems (orbital, surface and analogue)
- Life-Support Systems
- Space Suit technology
- Robotics (IV, EV and human-robot interaction)
- Space validation and test equipment design (e.g. Vacuum Chamber with lunar regolith; "dirty" vacuum chambers)



EUROHAB habitat platform during tests in Luxembourg.

SPARTAN SPACE

PRODUCTS & SERVICES

SPARTAN SPACE provides systemic solutions for space habitation systems. These include life-support systems, energy management, airlock developments and robotics.

SPARTAN SPACE is also active in the development of platforms for ergonomic tests and analogue missions for human and robotic space exploration.

SPARTAN SPACE personnel is qualified in space and maritime engineering and can support the transition of technologies from the space sector to the maritime sector and reverse.

MAJOR SPACE PROJECTS & REFERENCES

EUROHAB: A lunar surface secondary habitat conceived as a payload to a robotic lander. The system was developed as a full-scale mock-up to serve as test platform for technology validation and analogue tests.

I-HAB: Human In The Loop (HITL) test model to validate the internal layout and perform fit-check for internal partners equipment's (JAXA and NASA).

LDE: Mock-up of the ESA EL3 lander for simulations and tests. The system is located at the European Astronaut Centre EAC, Cologne.

LISE: Development of a lunar surface habitat concept in cooperation with CNES.

DTVC: Dirty-Vacuum Chamber for an ESA Facility in Luxembourg. The system will provide a lunar surface test environment (with regolith simulant)

POINT OF CONTACT

ADDRESS 167 Plage de l'Estaque
13016 Marseille France

WEBSITE www.spartan-space.com

PHONE +33 (0)6 27 21 49 01

POINT-OF-CONTACT : Peter WEISS, Founder and CEO

TURNOVER 0,5 M€

WORK FORCE 4 employees

SPACE TURNOVER 0,5 M€

SPACE WORK FORCE 4 employees

Orbital systems
 Ground segments
 Launchers
 Transversal competencies



Global industrial group, SPHEREA is specialized in designing and manufacturing modular test solutions for the entire life cycle of critical and complex systems.

COMPETENCIES & CAPABILITIES

Test means, development, manufacturing and maintenance for aeronautic, defense, transportation, energy, space and industry.

SPHEREA main competencies: avionics, power electronics, optronics, RF/microwave, mechatronics.

- AIT-AIV simulation and test solutions
- EGSE (Platform and payload)
- Lab and GSE testing solutions: Electronics, Avionics, optronics, Radiofrequency/Microwave



SPHEREA

PRODUCTS & SERVICES

- Tailor-made certification service
- Complete test facilities
- Simulation platforms
- Integration test benches
- Final Assembly Line test systems
- Production test benches
- Wiring test systems
- Test benches: screening, diagnostic and repair
- System obsolescence services
- Support services and solutions

MAJOR SPACE PROJECTS & REFERENCES

- Test Engineering Services for Airbus D&S Launchers
- ARIANEGROUP – Test bench MANG ARIANE 6
- Test Engineering Services for AIRBUS D&S Satellites
- RF Integration Test Benches - ARGOS 4
- Obsolescence treatment for AIRBUS D&S Satellites
- EGSE Development for AIRBUS D&S Satellites
- Power Conditioning & Distribution Units EGSE Thales AS Belgium
- Airbus DEFENCE & SPACE – Solar Array Panel Simulator
- Solar Array Simulator for Thales Alenia Space Belgium
- Drive Control Unit (DCU) for Thales Alenia Space Belgium
- Power Processing Unit (PPU) for Thales Alenia Space Belgium
- TVAC & RF amplifiers Q-Band Thales Alenia Space Belgium

POINT OF CONTACT

ADDRESS 109 avenue Eisenhower, CS 42326
31023 Toulouse CEDEX 1 - France

WEBSITE www.spherea.com

PHONE +33 (0)5 34 55 40 00

POINT-OF-CONTACT : O'CONNOR, Mickaël, Head Of Sales OEMs Market,
mickael.oconnor@spherea.com, +33 5 34 55 40 59 +33 7 86 80 67 96

TURNOVER 104.049 M€ (2019)

WORK FORCE As of 05/31/2020, there were 379 permanent employees

Space planes
Transversal competencies



Spirit Technologies, a specialist in mechanical engineering, designs and integrates **complex high added-value mechanical assemblies** in the aerospace, energy and industrial (specific) fields.

The values of Spirit Technologies are based on **20 years' experience in industry**. A concern for work well done, together with the notion of service and human values, are in the company's DNA.

COMPETENCIES & CAPABILITIES

Spirit Technologies took the decision to create an industrial grouping bringing together all production capacities to ensure full compliance with customer requirements. The objective is to retain control of the entire process, coupled with a global vision of the project.

An industrial model based on long-proven expertise in engineering and manufacturing means we can deliver solutions that perfectly match the specific needs of our customers, from the feasibility study to the commissioning.

- Design, definition & mechanical analyses
- Manufacturing
- Qualification & certification checks
- Control & monitoring & MMI



SPIRIT TECHNOLOGIES

PRODUCTS & SERVICES

Spirit Technologies aims to expand its scope of activities to build skills and create added value within the company. To do this, in 2021, we will build an integration hall, also equipped with an ISO 5 clean room to produce sensitive equipment.

SPIRIT TECHNOLOGIES aims to become a major player in the development and production of industrial resources in the fields of aeronautics and aerospace.

Spirit Industries, is the manufacturing entity of Spirit Technologies which brings together:

- Precision machining
- Boilerwork
- Electrical realization & automation

MAJOR SPACE PROJECTS & REFERENCES

THALES ALENIA SPACE

- NEOSAT: CATR, Clamp Band, Hoisting device, Vibration frame
- CO2M: All MGSE AIT (In progress)

OHB

- MTG: IRS ambient test frame
- PLATO: MGSE AIT (Vibration fixture)

THALES UK

- FLEX: Clamp band

CLAMP BAND (SPIRIT TECHNOLOGIES PRODUCT): The clamp band is used for holding the spacecraft by its launcher interface during handling, vibration and thermal tests. Different dimensions are developed (for S/C Ø940, Ø1200, Ø1600).

POINT OF CONTACT

ADDRESS 1, avenue du centre
06150 CANNES France

WEBSITE [www.https://spirit-technologies.fr](https://spirit-technologies.fr)

PHONE +33 (0)4 93 49 13 29

POINT-OF-CONTACT : Ripert Hugues, CEO, hugues.ripert@spirit-technologies.fr
+33 (0)6 14 32 91 92

TURNOVER 2.7 M€

WORK FORCE 20

SPACE TURNOVER 1.5 M€

SPACE WORK FORCE 12

Orbital systems
 Satellites
 Balloons
 Transversal competencies



Firmly positioned in the field of high technology, STEEL ELECTRONIQUE Company carries the bulk of its activities in the field of space electronics, where its main customers are space agencies or research centers (CNES, ONERA, CEA, CNRS...) or Prime contractors like Airbus Defense and Space and Thales Alenia Space.

COMPETENCIES & CAPABILITIES

- Electronic design and development (analog, digital, FPGA, software...)
- PCB layout: high density, flex-rigid...
- Mechanical & thermal design and analysis
- Radiations and reliability analysis
- Components procurement following space quality standards (hi-rel, Rad Hard, or COTS qualification...)
- EMS: PCB assembly according to ESA/CNES qualification
- Qualification and acceptance testing (electrical, vibrations, shocks, EMC, thermal vacuum...)
- Project management according to ECSS and CNES flow
- EN9100 & CNES ASF

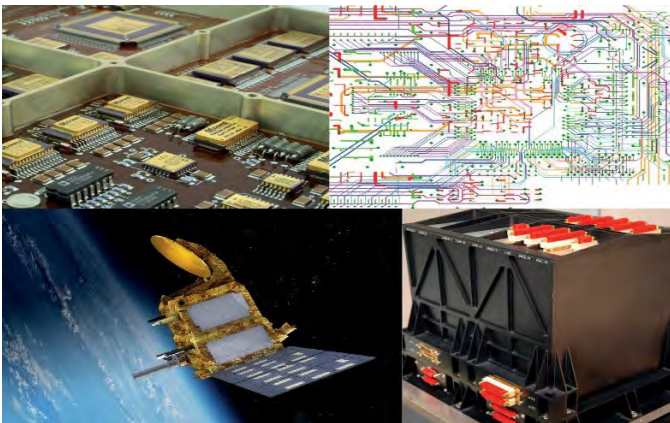

STEEL ELECTRONIQUE

PRODUCTS & SERVICES

- On Board Computers for small satellites Platforms or Payloads
- Payload Data Handling (Mass Memories, CCSDS Formatting Units, Cyphering, Authentication)
- Instruments and Interface Control Units
- DC/DC converters
- Front-end electronics
- High Performance and Versatile Single Board Computers for
- Nanosatellites / CubeSat
- Interface boards: 1553, Space Wire, RS422, standard I/O, Wizard Link...

MAJOR SPACE PROJECTS & REFERENCES

- Spot, Champ, Grace, Rosetta
- Myriade microsattellites : Demeter, Parasol, Picard, Essaim, Spirale,
- Elisa, SSOT, Alsat-2, VNRedsat, Microscope, Taranis
- Herschel, Corot
- SWARM, SARAL
- Plato, Proba-V, Mascot/Hayabusa-2
- GFO, Myriade-Evolutions / Merlin, SWOT
- Exomars 2016-2020, Solar-Orbiter
- Eyesat, Angels
- Argos-4 / Oceansat-3, Microcarb
- MARS 2020, Euclid, Juice

POINT OF CONTACT

ADDRESS ZA de Cantalauze, Route de Mondavezan
F-31220 Martres-Tolosane - France

WEBSITE www.steel-electronique.fr

PHONE +33 (0)5 61 98 45 29

POINT-OF-CONTACT: Remy Laffourcade

TURNOVER > M€5

WORK FORCE 50

SPACE TURNOVER M€5

SPACE WORK FORCE 50

Orbital systems
Launchers
Transversal competencies



Stirweld democratizes Friction Stir Welding (FSW): the less expensive FSW solution on the market for welding aluminium, copper or dissimilar material.

COMPETENCIES & CAPABILITIES

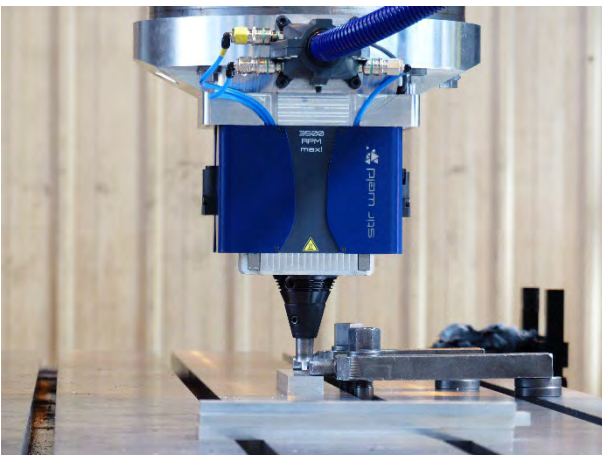

STIRWELD

PRODUCTS & SERVICES

Stirweld team has developed a technology allowing the use of friction stir welding (FSW) on all types of CNC machine. We support you in the optimisation of your machine park and the integration of a new know-how to offer to your customers. Our FSW head for CNC offers identical performances as a special FSW machine (effort control, quality recording, ...). Its other advantages:

- Low investment cost compared to special machines or FSW robotic stations.
- Adaptability: despite the absence of standard machining centres, the FSW head of Stirweld can be adapted to all CNC machines.
- Easy to use and to install: after the first installation, the user can mount and dismount the FSW head in a few minutes, easily switching from machining to welding and vice versa.

MAJOR SPACE PROJECTS & REFERENCES

Our references: Ariane, Airbus, Boeing

POINT OF CONTACT

ADDRESS 1 rue Jean de Thevenot 35760 Saint-Grégoire France

WEBSITE www.stirweld.com

PHONE +33 (0)6 47 49 74 19

POINT-OF-CONTACT : Dubourg Laurent, CEO, laurent.dubourg@stirweld.com

+33 (0)6 47 49 74 19

TURNOVER 2 M€

WORK FORCE 27

SPACE TURNOVER 0,7 M€

SPACE WORK FORCE 8

Transversal competencies
Satellites
Ground segments



At ST, we are 46,000 creators and makers of semiconductor technologies mastering the semiconductor supply chain with state-of-the-art manufacturing facilities. An independent device manufacturer, we work with more than 100,000 customers and thousands of partners to design and build products, solutions, and ecosystems that address their challenges and opportunities, and the need to support a more sustainable world. Our technologies enable smarter mobility, more efficient power and energy management, the wide-scale deployment of the Internet of Things and 5G technology. Space is supported with rad-hard products.

COMPETENCIES & CAPABILITIES

Design, test, assembly, qualification up to ESCC or QML-V, and supply chain of a wide range of radiation hardened electronic components from diodes, and transistors up to high-density mixed-signal and RF ASICs, through power management, interfaces, analog and image sensors for traditional and New Space, as well as other high reliability applications.

The technology and product hardening know-how is applicable to the most advanced technologies, including FinFET, whether ST's or from a third party.



STMicroelectronics

PRODUCTS & SERVICES

ST portfolio of ESCC, QML-V or JAN qualified products includes diodes, bipolar transistors, Power MOSFET as well as logic, interfaces, analog and power management integrated circuits.

ST's portfolio of proprietary differentiated technologies includes Planar, SiC and GaN (discretes), 130 nm mixed-signal CMOS, BCD (Power ICs), SiGe 130 nm and 55 nm (RF ICs), and 65 nm Bulk and 28 nm FDSOI (high-density mixed-signal and RF), as well as CMOS Imaging (Image sensors). Most of these technologies proven rad-hardness capabilities.

ST Rennes plant is ESCC, QML and JAN certified. It supports wire bonded ceramic hermetic packages from LCC-2 to CLGA625, Flip-chip on ceramic and organic substrate up to CLGA 1752 / BGA1752.

MAJOR SPACE PROJECTS & REFERENCES

Since the early 1980s, ST Space components have been used in most, if not all, European satellites and missions, and in a large majority of all space programs all over the world, including Mars Curiosity and the James Web Space Telescope.

Some ASICs and third-party products using ST technologies, such as 65 nm, 28 nm FDSOI, and SiGe 130, are currently flying and additional ones are in development.

POINT OF CONTACT

ADDRESS 3 rue de Suisse, CS60816, 35208 Rennes Cedex 2, France

WEBSITE www.st.com/en/space-products.html

PHONE +33 (0)2 99 26 48 00

POINT-OF-CONTACT Pierre Hirschauer - EMEA Space & Hirel Sales Manager
Pierre.hirschauer@st.com – Tel : +33 (0)1 5807 7865

TURNOVER 12.7 M€ in 2021

WORK FORCE 46,000 employees

SPACE TURNOVER Confidential

SPACE WORK FORCE ~175 employees

Launchers
Satellites
Transversal competencies



Sylphaero is a startup working on electrothermal propulsion for high speed vehicles, using thermal plasmas generated with electric arcs. The main goal is to offer an alternative to other electric airbreathing propulsion systems such as electromagnetic motors, to reach higher speeds and power levels.

This technology, quite close to arcjets, can be used within any atmosphere. It can also be derived into gas heaters used to reproduce the conditions of atmospheric reentry.

COMPETENCIES & CAPABILITIES

Sylphaero currently offers an expertise in:

- Thermal plasmas
- Plasma chemistry
- Electric arcs
- Propulsion
- Energy management and power electronics

We have the capabilities to rapidly design and produce plasma torches.

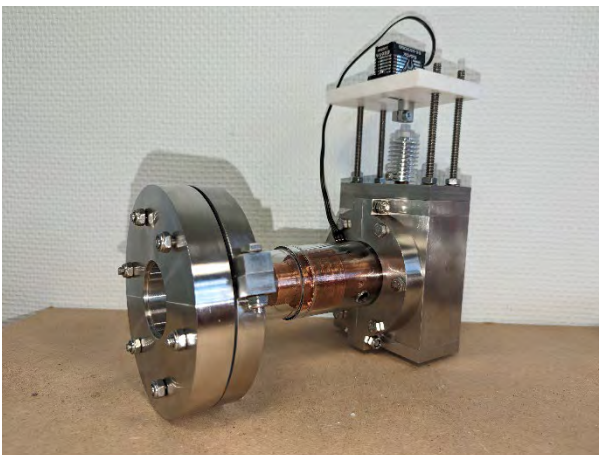

SYLPHAERO

PRODUCTS & SERVICES

Sylphaero currently offers R&D and prototyping services related to its competencies, in particular electric arcs, thermal plasmas and electric propulsion. Electric propulsion includes turbojets, ramjets, scramjets, shcramjets, arcjets, Lorentz Force Accelerators.

Any application that requires to generate hot or ionized gases is also within our scope, such as plasma wind tunnels.

MAJOR SPACE PROJECTS & REFERENCES

Sylphaero is currently under contract with the CNES to study the feasibility of thermal plasma propulsion for launchers, boosters and SSTOs.

Sylphaero is also under contract with an undisclosed defense company to conduct the conceptual design of a thermal plasma propulsion system for supersonic and hypersonic vehicles.

POINT OF CONTACT

ADDRESS 25 rue Marcel Issartier,
33700 Mérignac, France

WEBSITE www.sylphaero.com

PHONE +33 (0)7 71 01 61 95

POINT-OF-CONTACT : ENGEMANN, Damien, CEO
damien.engemann@sylphaero.com, +33 7 71 01 61 95

TURNOVER 0.07 M€

WORK FORCE 6 employees

SPACE TURNOVER 0.06 M€

SPACE WORK FORCE 5 employees

Orbital systems
Satellites
Transversal competencies



SYMETRIE designs and manufactures precision positioning & motion systems that meet the most specific needs of industrialists and research institutes.

SYMETRIE is specialized in hexapods, parallel kinematics mechanical systems used to position an object in space in 6 degrees of freedom with high accuracy, resolution and stiffness.

COMPETENCIES & CAPABILITIES

SYMETRIE provides to space industry companies ready-to-use hexapod machines, delivered with ergonomic software for a quick start.

These hexapods can be used to accurately test and position satellite antennas, to align and assemble components together, to adjust and calibrate optical benches or to verify the quality of the optical instruments and their subassemblies.



ZONDA Hexapod: Calibration of space optical instruments for MTG satellites
Credits: Bertin Technologies

SYMETRIE

PRODUCTS & SERVICES

A hexapod is a parallel kinematic structure composed of a mobile platform linked to a fixed platform by 6 actuators and 12 joints.

This design allows to move an object placed on the mobile platform in 6 DOF (Degrees Of Freedom) with submicrometer resolution. In other words, the hexapod can move an object along the 3 translations (Tx, Ty, Tz) and the 3 rotations (Rx, Ry, Rz); the pivot point is configurable via software.

Vacuum and clean room versions are available.

Symétrie also offers comprehensive services including installation, training and maintenance.

MAJOR SPACE PROJECTS & REFERENCES

Space projects: BepiColombo, EnMAP, Gaia, JWST, MTG, PLATO, Sentinel 5...

References: Airbus Defense & Space, AMOS, CSL, ESA, Eutelsat, IAS, IUCAA, LAM, Leonardo, MDA, OHB, Safran Reosc, SpaceCom, Thales Alenia Space...

POINT OF CONTACT

ADDRESS 10 Allée Charles Babbage
30000 Nimes, France

WEBSITE www.symetrie.fr

PHONE +33 (0)4 66 29 43 88

POINT-OF-CONTACT Olivier Lapierre, CEO, olivier.lapierre@symetrie.fr

TURNOVER 8 M€

WORK FORCE 45

SPACE TURNOVER 1,9 M€

SPACE WORK FORCE NC

Orbital systems
 Launchers
 Ground segments
 Satellites
 Transversal competencies



SYNTONY is an industrial company, specialized in the design and manufacturing of scientific and technical products dedicated to radio navigation.

SYNTONY works mainly in aeronautics and space, either for infrastructure, or applications.

SYNTONY has been selected in ESA BIC Sud France (ESA: European Space Agency; BIC: Business Incubator Center).

COMPETENCIES & CAPABILITIES

SYNTONY business is to implement GNSS (Global Navigation Satellite Systems) algorithms in software on domains where the current technology is done in hardware, bringing upgrade facilities & easy feature improvement for everybody. The implemented GNSS algorithms cover mainly embedded RECEIVERS and constellation SIMULATORS, for embedded systems, for AIT, but also for ground applications.



SYNTONY

PRODUCTS & SERVICES

Main Products:

- **SOFTSPOT:** GNSS Receiver (multi-constellation, Multi-frequency), software based.
- **CONSTELLATOR:** best-of-class GNSS Constellation Simulator, dedicated to be integrated in hardware-in-the-loop Testbenches.
- **ECHO:** high fidelity record & replay solution for GNSS signals. Can support up to 3 channels, 100Mhz, up to 16 bits I/Q.
- **SUBWAVE:** GPS/GALILEO signal coverage extension for subway stations and tunnels. Application: safety and passenger guidance.
- **SoftSpot IoT:** IoT low consumption GNSS receiver for tracker applications (for example, LEO IoT constellation).

MAJOR SPACE PROJECTS & REFERENCES

SYNTONY has successfully delivered engineering, test and flight hardware and software for a number of international customers ranging from companies such like AIRBUS, ONEWEB, AIRBUS DS, THALES ALENIA SPACE, CNES, ESA, ISRO, OHB, COLLINS, HONEYWELL, MAXAR (SSL), RUAG SPACE, and many others.

Just some examples of projects: all the satellites launched by OneWeb have been tested successfully by our GNSS simulator.

And also, because it is even more specific, we can cite the launcher trajectory simulation or GEO trajectory simulation (including elliptic phase) delivered successfully by our GNSS simulator and used by the major industrials or agencies.

POINT OF CONTACT

ADDRESS 5 Chemin de Chèvrefeuille 31300 Toulouse France

WEBSITE www.syntony-gnss.com

PHONE +33 (0)5 81 319 919 or +1 646 799 0101

POINT-OF-CONTACT : François GOUDENOVE, Chief Sales Officer

francois.goudenove@syntony-gnss.com

+33 (0)5 81 319 919

TURNOVER 5 M€

WORK FORCE 50

SPACE= TURNOVER 5 M€

SPACE WORK FORCE 50

Satellites
Ground segments
Transversal competencies



Syrlinks, a French company, designs and delivers worldwide RF communication products to address four market segments: Space, Defense, Safety and Time-frequency.

The Space business unit has developed four product ranges: TT&C, Telemetry Transmitters, GNSS and SDR Payload. This meets different market segments in terms of satellite integration (Nano/Cubesat, Micro and Mini satellites) and in terms of applications such as Earth Observation, Satcom, GNSS Services, LEO PNT, Spectrum monitoring, etc. Syrlinks masters the design of reliable product based on COTS (Components-Off-the Shelf) components, enabling cost-reduction for New Space.

COMPETENCIES & CAPABILITIES

The reliability of Syrlinks products has been demonstrated by the development and manufacturing of more than 1000 units cumulating more than 800 years in orbit, with no default observed, even on missions longer than initially expected. The large experience of its experts allows to combine reliability, low consumption, and miniaturization of radios for LEO missions up to 10 years in orbit, especially compliant to NewSpace, ESA CLASS 3 and CLASS 2 Standards.

Syrlinks benefits of an impressive industrial capacity, with extended clean room, top of the art laboratory equipment, complete qualification and validation tools, and highly skilled and motivated staff.



SYRLINKS

PRODUCTS & SERVICES

Syrlinks offers the largest inflight proven portfolio of radios for LEO and deep space missions, and especially for small satellites, from “Medium Size” up to 10 years lifetime, to “Nano/Cube Satellites”:

- Space radios such as High Data Rate transmitters, TT&C or ISL transceivers, in different frequency bands (L, S, X, K), and several quality levels from COTS to ESA CLASS 3 & 2 (equivalent to NASA Level II & I).
- Antennas
- Software defined radios for payload dedicated to IoT/M2M or RF sensing applications, with wide & narrow band receiver, mass memory and X, L band-transmitters
- GNSS Receiver and services, & POD, based on multi-frequencies/multi-constellations Software Defined Radio platform
- Oven Controlled Crystal Oscillators (OCXO): the best physical combination between power consumption and frequency stability, making the EWOS family the best choice for all demanding embedded applications

The Syrlinks field of expertise also extends to the ground segment of the space domain. The company develops and manufactures distress and/or geolocation beacons and modules that work with Argos and/or Cospas-Sarsat systems.

MAJOR SPACE PROJECTS & REFERENCES

- Space agencies: CNES, ESA, NASA, LAPAN, DLR, ISRO, KARI
- Large system Integrators: Airbus D&S, OneWeb Satellites, Thales, KINEIS, OHB, Yuzhnoye Design Office, ... and others
- Medium size & nano satellites: QuinetiQ, Berlin Space Technology, Space Flight Laboratory, Utias SFL, Chang Guang Satellite Technology, ... among > 20 countries
- Lunar missions: Astroscale, ...

POINT OF CONTACT

ADDRESS Headquarters : 28 rue Robert Keller, Zac des Chzamps Blancs
35510 Cesson-Sévigné – France

Toulouse Offices : 232 rue de la Découverte, Innopole
31670 Labège - France

WEBSITE www.syrlinks.com

PHONE +33 (0)2 99 00 94 52

POINT-OF-CONTACT: Guy Richard (CEO)
Eric Pinson (Space Business Unit Director)
Jean-François Pouilly (Toulouse Office Manager)

TURNOVER € 20 m

WORK FORCE 135

SPACE TURNOVER € 17 m



Transversal competencies

With more than 50 years of experience, Systronic is the industrial specialist for manufacturing PCBs dedicated to the aerospace market for worldwide satellites and launchers.

Being part of Cimulec group, our products are characterized by: a full range of qualification for industrial, aero-mil and space projects, a large technological range and background, high reliability, assistance from prototype to production.

COMPETENCIES & CAPABILITIES

Eight ESA qualified technologies:

- Non sequential rigid with Epoxy HTg
- Non sequential rigid-flex with Epoxy HTg
- Sequential rigid with Polyimide
- Sequential rigid flex with Polyimide
- Single sided rigid with RT/Duroid 5880
- Double sided rigid with TMM10i
- Sequential rigid Mixed Polyimide/PTFE
- Non sequential rigid with PTFE

Supplemented with a range of complementary technologies like HDI and Hyper frequency technologies, mixed PTFE-Polyimide build-ups, internal heat sinks, embedded resistors...

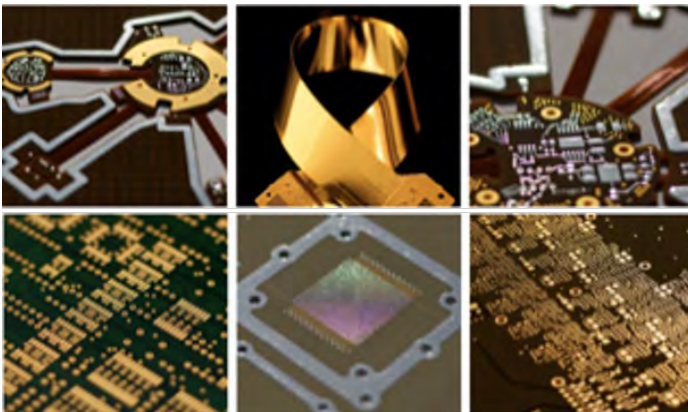

SYSTRONIC – CIMULEC Group

PRODUCTS & SERVICES

PCB (Printed circuit board) manufacturer.

Risk assessment expertise of PCB design - Design Rules Check methodology.

Support of our prototyping plant in Toulouse, with duplicated manufacturing processes for short lead time EM according to Systronic rules.

Quick Turn Around service in Systronic for Qualification models and Flight models.

Simulation of PCB structure fatigue through modeling.

LEMCI (Laboratory of Studies and Modeling for Printed Circuits): Joint laboratory dedicated to the reliability of printed circuit boards for high added value applications.

MAJOR SPACE PROJECTS & REFERENCES

Main customers:

- Airbus Defence and Space
- Thales Alenia Space
- Leonardo
- Kongsberg Norspace Aerospace
- ArianeGroup
- Safran Electronic and Defence

Projects supported by the main space agencies:

- CNES, ESA, NASA, DLR, JAXA, ISRO, KARI, ...

POINT OF CONTACT

ADDRESS	6 avenue de l'Atlantique 91940 LES ULIS France
WEBSITE	www.systronic.com
PHONE	+33 (0)169077071
POINT-OF-CONTACT:	ROY Vincent, Commercial Director vroy@cimulecgroup.com / syssales@cimulecgroup.com
TURNOVER	8 M€
WORK FORCE	55
SPACE TURNOVER	7 M€
SPACE WORK FORCE	55

Launchers
Satellites
Ground segments



Created more than 100 years ago, TECALEMIT AEROSPACE manufactures, exclusively for the aerospace sector, flexible, semi-rigid and rigid pipes for all types of circuits. The group is oriented toward an integration process strategy and know-how, in order to provide the best appropriate answer and go beyond customer's expectation. Our products are present in most civil aviation, business aviation, military aviation and space-related aircraft.

COMPETENCIES & CAPABILITIES

TECALEMIT AEROSPACE produce all piping system of the hydraulic and pneumatic circuits on aircrafts and spacecrafts:

- Fuel.
- Water, oxygen.
- air conditioning, wing de-icing.
- Cryogenic systems.
- Pyrotechnic systems.

Duct



Tubes



Hoses



Hybrid tubes



TECALEMIT AEROSPACE

PRODUCTS & SERVICES

TECALEMIT AEROSPACE is oriented toward an integration process strategy.

All products are systematically developed with our customers (co-engineering).

All parts are specially designed for our customers.

TECALEMIT AEROSPACE use vertical integration to design & manufacture products based on the best technical-economical compromise.

MAJOR SPACE PROJECTS & REFERENCES

ArianeGroup: Separation systems for Ariane 5 & Ariane 6, piping for the Vulcain 2 engine

Thales Alenia Space: Cooling systems for the Space Inspire telecom satellites.

POINT OF CONTACT

ADDRESS ZI du parc ds Boss, 9 route du Dôme
69630 CHAPONOST France

WEBSITE <https://www.tecalemmit-aerospace.com/>

PHONE +33 (0)6 42 14 39 95

POINT-OF-CONTACT: DENIS, Ludovic, Key account manager

TURNOVER 70 M€

WORK FORCE 550

SPACE TURNOVER 5 M€

SPACE WORK FORCE 30

Launchers
Satellites
Ground segments

TECALEMIT
TUBES

Created in Paris in 1932 and located in Chârost (Cher) – in the very heart of France – since 1960, TECALEMIT TUBES is a major precision metallic tube supplier to the most demanding markets, such as the aerospace, nuclear and medical industries.

COMPETENCIES & CAPABILITIES

TECALEMIT TUBES manufactures tubes from various materials and grades such as 304L / 316L / 321, 347 / 316Ti / 31021.6.9 / SAF / Inconel / Monel Nimonic / Nickel / Uranus B6.

Our cold-drawing process enables us to produce tubes with outer diameters ranging from a minimum of 0.50 mm to a maximum of 50.80 mm (wall thickness from 0.10 mm to 3.00 mm).



TECALEMIT TUBES

PRODUCTS & SERVICES

The products of TECALEMIT TUBES can withstand the hardest environmental conditions (temperature, pressure, etc.) and thus are suitable for applications that are critical for the operating safety of complex systems.

In aerospace, the tubes from TECALEMIT TUBES are notably used for the manufacturing of the hydraulic and pneumatic circuits of aircrafts (airplanes, helicopters) and spacecrafts (launchers, satellites): fuel, flight commands, water, oxygen, air conditioning, wing de-icing, cryogenic systems, pyrotechnic systems, etc.

MAJOR SPACE PROJECTS & REFERENCES

ArianeGroup: separation systems for Ariane 5 & Ariane 6, piping for the Vulcain 2 engine.

Thales Alenia Space: cooling systems for the Space Inspire telecom satellites.

POINT OF CONTACT

ADDRESS 10 rue de l'Industrie
18290 Chârost, France

WEBSITE www.tecalemit-tubes.com

PHONE +33 (0)2 48 26 20 12

POINT-OF-CONTACT: MOREAU, Christine, Sales Director
c.moreau@tecalemit-tubes.fr, +33 6 08 69 93 94

TURNOVER (2021) 8 M€

WORK FORCE (2021) 52

SPACE TURNOVER

SPACE WORK FORCE

Transversal competencies



TECHNATIUM offers a range of geospatial mapping solutions to democratize and facilitate access to geographic information system services (digitization of cadastres, local urban plans, dual GEOINT solutions, defense and security, land use and occupancy mapping, predictive mapping, solutions for evaluating real estate and economic trends, forest and biodiversity monitoring solutions, etc.) for the international market

COMPETENCIES & CAPABILITIES

- Development and integration of GIS software
- Development and integration of multi-source data processing algorithms
- Development of security and traceability software for data and infrastructures (security software for ground infrastructures, etc.)



TECHNATIUM

PRODUCTS & SERVICES

- Geo-cadastal and predictive mapping solutions
- GIS management platform for forest cover monitoring
- GEOINT-based livestock and human migration monitoring portal
- Real estate valuation tools based on market trends and geo-data
- Maritime surveillance platform
- Protection of port and airport infrastructure and cargo
- Climate monitoring platform

MAJOR SPACE PROJECTS & REFERENCES

A territorial management platform with tools for collecting, visualizing and processing land data via a Geoportal with a module for traceability and certification of property titles by blockchain.
Project carried out for a local authority in Africa.

POINT OF CONTACT

ADDRESS 55 Rue de Boétie 75008 Paris France

WEBSITE <https://technatium.com/>

PHONE +33 (6) 35 22 38 90

POINT-OF-CONTACT: Jean KOÏVOGUI, CEO TECHNATIUM

Jean.koivogui@technatium.com

+33 (6) 35 22 38 90

TURNOVER

WORK FORCE 6

SPACE TURNOVER

SPACE WORK FORCE

Ground segments
Launchers
Transversal competencies



TECHNIP ENERGIES is a global engineering company being capable to deliver worldwide global EPC contracts, mainly for energetic sectors such as Gas, Hydrogen, focused on Energy transition, and more generally in industries as Defense & Space fields for which Process and Safety considerations are prevailing.

COMPETENCIES & CAPABILITIES

- Project management,
- Engineering system for production industrial complexes,
- Specific expertise in pyrotechnical issues,
- Specific expertise for safety in operating (Hazop, Hazid,..),
- Specific expertise in industrial gases issues (cryogenic or not),
- Coating and materials issues,
- Quality assurance and HSE...



TECHNIP

PRODUCTS & SERVICES

- Engineering Studies (feasibility studies, Basic Design, Detailed Design, process of gases, specific expertise in safety and pyrotechnical issues, ...),
- Procurement services (European and Worldwide),
- Construction management,
- Precommissioning and Commissioning.
- Pyrotechnical studies.

MAJOR SPACE PROJECTS & REFERENCES

CSG – UPG – Guyana Propellant production plant in Kourou:

- Basic, Detailed Design, Procurement and Construction (1987-91)
- Additional infrastructure (2nd casting building) in 2003 to 2011
- Renewing of the UPG Digital Control System (2012-16)
- Adaptation of the existing NDT facilities (UPG - building 305) for quality control of P120 motors (Ariane 6 and Vega C launchers)

CSG – BIP and BPZ:

- Pyrotechnical expertise and assistance to ESA & CNES SDS

POINT OF CONTACT

ADDRESS 2126, Boulevard d La Défense
92741 NANTERRE Cedex France

WEBSITE www.technipenergies.com

POINT-OF-CONTACT: SEMERDJIAN Paul-Jacques, Business Development Manager
paul-jacques.semerdjian@technipenergies.com,
+33 (0)1 47 78 21 54 / + 33 (0) 6 30 70 58 72

TURNOVER 1 315 M€

WORK FORCE 3325 employees

SPACE TURNOVER 10 M€

SPACE WORK FORCE 50 employees

Satellites
Transversal competencies



We design and manufacture semiconductors and image sensors for space plus advanced systems and instruments.

Our radiation tolerant solutions increase capability and reduce cost of ownership in a wide range of space applications.

COMPETENCIES & CAPABILITIES

Teledyne e2v offers high-performance, ultra-reliable semiconductor solutions addressing critical functions across the entire signal chain – covering imagers, data converters, microprocessors, memory.

We are also serving the industry with assembly and test services.

Serving the avionics, industrial, medical, military, scientific and space sectors, the company is recognized as a world leader in the re-engineering and up-screening commercial technologies to deal with the most demanding of application scenarios.



TELEDYNE e2v

PRODUCTS & SERVICES

Our Space Solutions Include:

- Unrivalled microwave frequency capable data converters
- Advanced processors for high performance space-borne computing
- An exclusive range of Peregrine Semiconductor products
- Space qualified Assembly & Test services, with NASA's QML class V & Y certification
- We have supported over 250 space missions over the past
- High performance image sensor systems

Application Spotlight

- Telecomm Satellites
- Weather Satellites
- SAR Earth Observation
- Optical Earth Observation & Data Downlink

MAJOR SPACE PROJECTS & REFERENCES

From Planetary Exploration to Earth Observation, Teledyne e2v is proud of a rich and unique space heritage.

Key supplier to major primes including Airbus, Thales Alenia Space, Thales, SAC/ISRO, Boeing, and Raytheon, and technology partner to CNES, ESA, NASA, DLR, JAXA and NASA, we provided imaging sensors and electronic components for more than 250 missions around the world.

We have 40 years of heritage in supplying the space market.

POINT OF CONTACT

ADDRESS Avenue de Rochepleine - BP 123
38521 Saint-Egrève Cedex France

WEBSITE www.teledyne-e2v.com/

PHONE +33 (0)4 76 58 30 00

POINT-OF-CONTACT : Eric MARCELOT, Director of Business Development
eric.marcelot@teledyne.com

TURNOVER N/A

WORK FORCE 450 employees

SPACE TURNOVER 40 M€

SPACE WORK FORCE 200 employees

Ground segments
Transversal competencies



Created in 1950, Telerad has built an expertise of 70-year legacy in designing and manufacturing radiocommunications solutions for critical operations.

Telerad provides both our civilian and military customers with solutions of radios systems in the VHF and UHF bands.

In addition, Telerad offers toward the space industry radiofrequencies engineering services.

COMPETENCIES & CAPABILITIES

Mastering radiofrequencies design and industrialization is scarce. Telerad covers the entire chain from developments, prototyping, pre-industrialization and industrialization of complete/sub-systems:

- Power amplifier,
- Frequency synthesis,
- Software Defined Radio,
- HF design RF module,
- Equipments interconnexion,
- Signal processing,
- Analog / digital modulation,
- Test benches,
- Qualification / EMC.

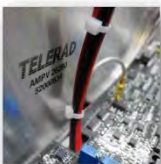

Power amplifier
Frequency synthesis



Software Defined Radio
Signal processing

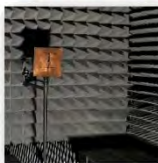

Test benches
Qualification / EMC



Analog / digital modulation



TELERAD

PRODUCTS & SERVICES

Telerad offers radiofrequencies engineering services, to anticipate and solve any issue related to interferences, propagation, synchronization, frequency stability, calibration, product RF performances, etc.

Our engineering department is composed of 15 engineers and can rely on our production workshop for prototyping and pre/industrialization of products.

Telerad is a renowned manufacturer of VHF and UHF radio systems for both the aeronautical and maritime sectors.

The offer extends to Navigation Aid Systems including Non-Directional Beacon and VHF Data Broadcast for differential GBAS landing systems (Ground Based Augmentation Systems).

MAJOR SPACE PROJECTS & REFERENCES

- Thales,
- Airbus,
- Honeywell,
- General Dynamics,
- Naval Group,
- Dassault,
- DGA,
- DGAC (French Civil Aviation Authority)
- FAA (US Civil Aviation Authority)
- SKEYES (Belgian Civil Aviation Authority)
- SKYGUIDE (Switzerland Civil Aviation Authority)
- Etc.

POINT OF CONTACT

ADDRESS 2 avenue de la butte aux cailles 64600 Anglet, France.

WEBSITE www.telerad.fr

PHONE +33 (0)5 59 58 55 00

POINT-OF-CONTACT: Puig, Leopold, Sales department
l.puig@telerad.fr, +33 (0)6 46 31 39 05

TURNOVER 12 M€

WORK FORCE 75 employees

Orbital systems
Ground segments
Launchers
Satellites
Transversal competencies



As a key player in space infrastructure operations for more than 30 years, Telespazio France supplies value-added satellite services and applications for geoinformation, navigation and telecommunications.

Telespazio France is the French subsidiary of Telespazio, a joint venture of Leonardo and Thales. Based in Toulouse, Telespazio France owns also facilities in Paris, Bordeaux and Kourou.

COMPETENCIES & CAPABILITIES

We provide a full range of satellite services:

- 1) Related with ground infrastructure & satellite operations: we operate the tracking, telemetry & control systems for the Ariane 5, Soyuz & Vega launchers, and all of the spaceport's telecoms systems. In Toulouse, we maintain CNES's network of ground stations and perform stationkeeping and mission operations for the vast majority of its satellites.
- 2) Related to large programs and downstream services: Through its involvement in Europe's Galileo, EGNOS and Copernicus programs, Telespazio France offers a large panel of value added services in telecoms, navigation and geo-information for private customers, defense & institutions.



TELESPAZIO FRANCE



MAJOR SPACE PROJECTS & REFERENCES

- Galileo and EGNOS engineering and operations support
- COPERNICUS Sentinel 1,2 & 3
Payload Data Ground Segment operations support
- SYRACUSE 4 telecoms satellites operations support
- COSMO-SkyMed French Defense User Segment exploitation

POINT OF CONTACT

ADDRESS 26 avenue JF Champollion
F-31023 - Toulouse - France

WEBSITE www.telespazio.com/fr

PHONE +33 (0)5 34 35 52 25

POINT-OF-CONTACT: Communication Director
elio.baino@telespazio.com

TURNOVER > €90m

WORK FORCE 425

SPACE TURNOVER > €90m

SPACE WORK FORCE 425

Launchers
Satellites
Balloons
Transversal competencies



t e m i s t h

TEMISTh is above all a team of **experts in thermal systems and advanced manufacturing** that supports industrial companies in the development of **tailored solution**:

- Design and optimization
- Advanced manufacturing
- Testing and qualification

The company, based in Marignane (France), provides R&D services for aerospace, defense, automotive, electronics, tooling sectors.

COMPETENCIES & CAPABILITIES

The team is composed of 8 engineers and 4 PhDs specialized in:

- Fluid and thermal simulations on HPC facilities (CFD)
- Design for Advanced Manufacturing (CAD, FEA)
- Topological and parametrical optimization
- Energy system design and optimization
- Performance testing

Based on TEAM Henri-Fabre technical center, we operate advanced manufacturing processes with a cluster of experts

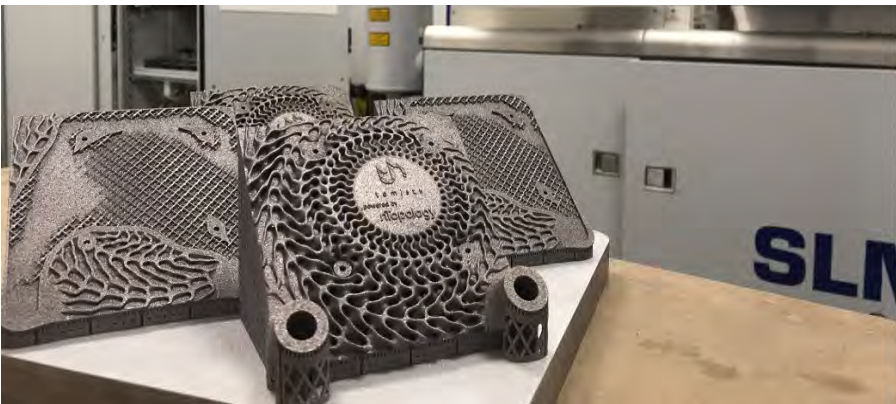

TEMISTH

PRODUCTS & SERVICES

We develop innovative thermal systems from the idea to its proof of concepts and further with the first qualifying tests. We focus on thermal and fluid performances, system integration, mass reduction and manufacturability.

We mainly work on cold plate for electronic and electric converters, conformal cooling for molding, nozzle regenerative loop, heat recovery on exhaust gas, heat pipes etc.

Our expertise on numerical simulation allows to work on

- Boiling, Condensation & Phase Change Material
- Surface roughness model
- Combustion & Particle injection
- Super critical fluid
- CFD and mechanical Topological optimization

The manufacturing technology is selected during the design (Additive manufacturing, machining, Brazing, Friction stir welding, etc.).

Our in-house capabilities of test allow performing single heated channel and air-liquid heat exchangers characterization.

MAJOR SPACE PROJECTS & REFERENCES

We made several confidential R&T activities for ESA, CNES, Ariane Group, Thales Alenia Space.

Between others, we won a call for tender for ESA. During this project we have developed and prequalified a cold plate for the thermal management of a human module for ESA.

We ensured sizing, design, CFD and mechanical simulations, project management for manufacturing and experimental tests (performance, leakage detection, welding control by IR camera, burst pressure, vibration).

POINT OF CONTACT

ADDRESS Bâtiment TEAM Henri-Fabre - *Technoparc des Florides, avenue Jacqueline Auriol 13700 Marseilles France*

WEBSITE www.temisth.com

PHONE +33 (0)4 42 10 06 83

POINT-OF-CONTACT : contact@temisth.com

TURNOVER 0.6 M€

WORK FORCE 13 employees

SPACE TURNOVER 0.1 M€

SPACE WORK FORCE 10 employees

Launchers
Satellites
Transversal competencies



Terakalis, specialist of **TeraHertz electromagnetic waves**, designs and manufactures highly innovative devices for the analysis and the **Non Destructive Testing** of the **internal properties** of non-metallic materials (polymers, elastomers, ceramics):

- **2D or 3D imaging defect:** porosities, homogeneity, corrosion under coating, cracks, delamination, foreign particles, adhesive bonds, welding control...
- Single or multi-layer cartography **thickness measurement** (thin or thick)
- **Material aging** characterization

COMPETENCIES & CAPABILITIES

For the health control of mechanical parts or structures or coatings, we have:

- a team of 4 expert engineers/doctors in the TeraHertz field, experienced in material inspection issues, also capable of developing electromagnetic modeling tools
- an exhaustive technological platform to test the performance of our solutions on samples, industrial parts with 2D or 3D geometry
- a team of 12 engineers/technicians to design and develop innovative solutions, experienced in the fields of TeraHertz optics, radio-frequency, electronics, mechanics, robotic, signal, image processing and AI
- 2 project managers for the management of R&D projects

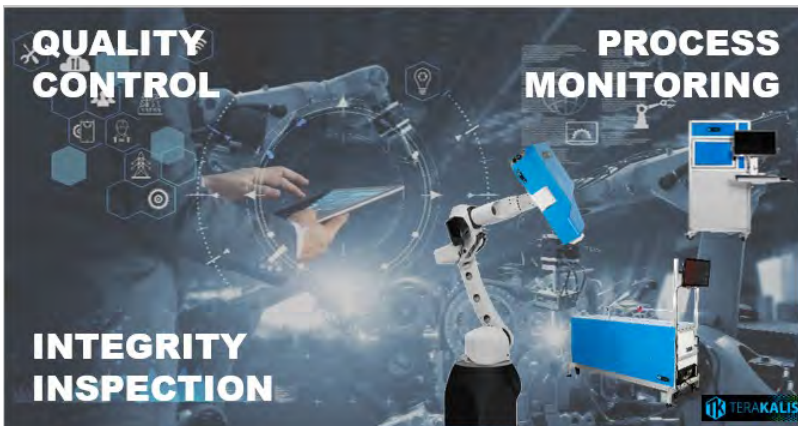

TERAKALIS

PRODUCTS & SERVICES

PRODUCTS

This technology is fast with high sensitivity of detection to heterogeneities, non-contact and non-harmful, portable, integrable on robot arm. We offer a full range of products, from lab equipment to integrated line-of-production equipment and portable solutions for operational sites.

SERVICES

We have a complete technology platform and a multidisciplinary team to carry out our services samples analysis, feasibility studies, prototyping, expertise. We have at our disposal instruments for imaging, thickness measurement, terahertz spectroscopy, Industrial robot, and IT tools like modelling, AI, etc.

We are able to support our clients during all phases of their project from start to finish. And offer you the necessary support whether for training, maintenance or after-sales service.

MAJOR SPACE PROJECTS & REFERENCES

Since its creation in 2013, Terakalis has carried out more than 250 demonstration studies in different sectors of activity such as aeronautics, defense & space, automotive or oil and gas. Today our solutions are used in industry.

We have participated in many projects in the space sector. As for example in 2017, we were the winner of the ESA Bic Sud France competition. In 2020 we were a finalist in an open innovation competition organized by Ariane Group in the predictive maintenance category.

We are currently working with various space players, in particular with CNES, Thales Alenia Space, Avio and Air Liquid.

POINT OF CONTACT

ADDRESS 256, rue de Thor
34000 MONTPELLIER France

WEBSITE www.terakalis.com

PHONE +33 (0)4 11 93 73 67

POINT-OF-CONTACT : Sabri BEN KHEMIS, commercial engineer
s.benkhemis@terakalis.com, +33 (0)6 03 21 03 47

TURNOVER > 1M€

WORK FORCE 20 employees

SPACE TURNOVER NC

SPACE WORK FORCE 20 employees

- Orbital systems
- Satellites
- Ground segments
- Balloons
- Transversal competencies



Ternwaves has invented & developed a revolutionary waveform for direct-to-satellites (LEO/MEO/GEO) & terrestrial connectivity, called Golden Modulation. This fundamental technology solves the problem of capacity limitation of IoT and sat-to-phones networks, crucial for their massive markets in full growth, while guaranteeing an ultra-resilience (very high robustness to jamming and fully operational even when GNSS signals are jammed), the ultimate range, a very low energy consumption, and a very low cost.

This technology offers a performance 300 times higher than that of SpaceX/Swarm Technologies regarding the capacity and therefore the competitiveness of satellite IoT and sat-to-phones networks.

Golden Modulation can also provide geolocation without GNSS assistance, important for connected device autonomy and in case of GNSS signals jamming.

COMPETENCIES & CAPABILITIES

TERNWAVES is specialized in wireless communication.



TERNWAVES

PRODUCTS & SERVICES

■ Direct-to-satellite & bi-directional, resilient & secure connectivity technology – called Golden Modulation

→ This technology is delivered as a software to be ported:

- on LEO/MEO/GEO satellites SDR (Software-Defined Radio) based payloads without any hardware change. It can even be ported on satellites already in orbit by simple software upload (OTA).

Note: For GEO satellites not having an SDR based payload, this technology is also fully compliant with satellite mirroring operation thanks to no strong latency requirements

- on connected devices

■ GNSS free geolocation services leveraging Golden Modulation technology

This technology can operate in any frequency bands, including ISM bands thanks to its very high robustness to interferences.

It does not request GNSS signals to operate – thus resilient to GNSS signals jamming.

It is also compatible with any protocol to easily integrate into any existing IoT networks.

MAJOR SPACE PROJECTS & REFERENCES

Supported by European Space Agency & CNES, in partnership with Kineis & Loft Orbital for RF Space Lab project on YAM-5 satellite, identified as a game changer for IoT connectivity by CNRS, awarded best 2022 French startup for Data & IA by La Tribune, selected as a Distinguished Member of the 100 Innovators of 2022 for Le Point magazine, selected as the most promising 10 space tech startups in Europe by SpaceFounders, won Eurosatory 2022 GICAT Innovation Start up prize, ...

POINT OF CONTACT

ADDRESS 13 rue Sainte Ursule
31000 Toulouse, France

WEBSITE <https://www.ternwaves.com/>

PHONE +33 (0)7 64 68 77 93

POINT-OF-CONTACT DUCLERCQ, Julie, CEO

julie@ternwaves.com +33 (0)7 64 68 77 93

TURNOVER not communicated

WORK FORCE 5 employees

SPACE TURNOVER not communicated

SPACE WORK FORCE 5 employees

Orbital systems
Satellites
Ground segments
Transversal competencies



Thales Alenia Space, a JV between Thales (67%) and Leonardo (33%), manufactures satellites and provides space-based technologies for telecommunications, navigation, Earth observation, environmental monitoring, exploration and science applications, as well as orbital infrastructures. Through the Space Alliance, Thales Alenia Space and Telespazio provide a complete range of solutions including services. The company operates in ten countries, with 17 facilities in Europe and an industrial plant in the United States.

COMPETENCIES & CAPABILITIES

Thales Alenia Space offers a wide range of state-of-art technologies and solutions matching all its customers' needs. Thales Alenia Space is capable of providing complex end-to-end systems, satellites, ground segments, equipment and space electronics covering the following activities: telecommunications, Earth observation, navigation, science, exploration including orbital infrastructures and space transportation systems. The company also leverages on Thales' longstanding experience to propose the highest level of cybersecurity to its customers.

Designed to bolster the company's innovation culture and to stimulate intrapreneurship, Thales Alenia Space owns an Innovation Cluster tasked with accelerating the development of innovative projects across and outside the Company.



THALES ALENIA SPACE

PRODUCTS & SERVICES

Product lines answering to telecommunications operators' needs: Spacebus 4000 B2 satellites, well suited to the needs of regional operators, Spacebus NEO solutions for very high throughput satellites, that deliver broadband connectivity worldwide, and Space Inspire solution, that is fully digital and reconfigurable in orbit. Full end-to-end system, including the satellite and ground segment. Unique technological legacy as prime contractor of 3 constellations.

Earth Observation satellites featuring high and very high resolution radar and optical payloads as well as ground segments. Top industrial partner in environmental monitoring programs. Unique legacy in constellations, navigation and Earth Observation to serve new markets linked to Space Situational Awareness, High Revisit optical observation or the Internet of Things.

Satellite navigation systems, with EGNOS and Galileo, and offers Safety of Life services used in particular for aviation and transport applications.

MAJOR SPACE PROJECTS & REFERENCES

Telecommunications constellations built under Thales Alenia Space prime contractorship: GlobalStar 2, O3B and Iridium®NEXT (125 satellites operational in orbit). Selected in 2021 to build Telesat's Lightspeed constellation including 298 LEO satellites.

Top industrial partner onboard European Copernicus environment monitoring program. In 2020, Thales Alenia Space was chosen for 5 of the 6 High Priority Copernicus Missions, 3 as prime contractor – CIMR, ROSE-L, CHIME – and will supply payloads for 2 other missions: CO2M and CRISTAL. Pioneer in space altimetry, Thales Alenia Space built all the Meteosat weather satellites under its prime contractorship.

Responsible for 1st generation Galileo Mission Segment (GMS) and Galileo Security Facility (GSF), Thales Alenia Space was ordered 6 Galileo 2nd Generation satellites in 2021. Current EGNOS system was developed under Thales Alenia Space's prime contractorship. Thales Alenia Space is one of the 2 space companies in the world to deliver certified Space-Based Augmentation Systems.

Providing half of the ISS' pressurized volume, Thales Alenia Space will deliver numerous pressurized modules for Lunar Gateway and Axiom commercial space station. Venus, Mars, Saturn, Mercury, the Sun, the Moon, deep space, asteroids and comets... Thales Alenia Space contributed to major international science and space exploration missions, including ExoMars as prime contractor.

POINT OF CONTACT

ADDRESS 26 avenue Jean-François Champollion
31100 Toulouse - France

WEBSITE www.thalesaleniaspace.com

POINT-OF-CONTACT : communication.web@thalesaleniaspace.com

TURNOVER 1850 M€ (2020)

WORK FORCE 7 700 employees

Transversal competencies



From secure software to biometrics and encryption, Thales DIS (Digital Identity & Security) technologies and services enable businesses and governments to issue and authenticate digital identities and protect data associated to these so they stay safe at rest and in motion, in personal devices, connected objects, the cloud and in between.

COMPETENCIES & CAPABILITIES

- ▶ **Identity & Data Protection:** Help organizations protect their most sensitive data and software, secure the cloud and achieve compliance through advanced encryption, logical access management and software licensing solutions. Secure physical access to sensitive sites using seamless and touchless biometrics (Facial recognition...)
- ▶ **Mobile & IOT Connectivity Solutions:** Enable seamless connectivity across cellular networks and strong digital identities for both people and devices. (Mobile Private Networks, 5G Connectivity...). Connect devices (cars, medical equipment, smart meters...) via cellular networks to the Internet, secure their identities and data, manage their lifecycle, and analyze real-time data transforming it into business intelligence.



THALES DIS

PRODUCTS & SERVICES

- ▶ Identity & Access Management: Multi-Factor Authentication, Cloud Single Sign On, PKI (Public Key Infrastructure).
- ▶ Data Protection: Encryption and Key management for Cloud applications, Compliance & Sovereignty. (Hardware Security Modules)
- ▶ Software Protection & Licensing: hardware/software/cloud.
- ▶ IOT Cellular connectivity: 3G/4G/5G modules, modems, eSIM.
IoT management: soft update, device performance, activation.
Trusted Key Management: secure provisioning, device identity mgmt.
- ▶ SIM & Secure Elements: 4G/5G and Industrial SIM, eSE, eSIM.
- ▶ Connectivity & Security solutions: Remote subscription mgmt., IoT Safe PKI SIM, Secure OTA services, Trusted Digital Identity.
- ▶ AI & Advanced analytics for MNOs: Operations analytics, Subscriber & devices behavioral analytics, RPM.
- ▶ Biometric Identification & Verification Solutions: for Border crossing, Civil registry, Physical access control, Law enforcement, Digital customer enrollment (Facial Recognition), and High Temperature Detection technologies for Physical screening and access Control.

MAJOR SPACE PROJECTS & REFERENCES

Thales DIS has more than 30 000 customers around the world. Among these customers, many of them are operating in the Space industry.

Most solutions used by our Space customers consist in:

- Strong authentication solution to secure access to networks, applications and services
- Protection of data in motion and at rest using certified Hardware Security Modules and Encryption devices and services.

POINT OF CONTACT

ADDRESS 6, rue de la Verrerie
92190 Meudon - France

WEBSITE www.thalesgroup.com/en/markets/digital-identity-and-security

PHONE +33 (0)1 55 01 50 00 (Meudon offices)

POINT-OF-CONTACT: www.thalesgroup.com/en/dis-contact-us

TURNOVER n.c.

WORK FORCE n.c.

SPACE TURNOVER n.c.

SPACE WORK FORCE n.c.

Orbital systems
 Launchers
 Satellites
 Ground segments
 Balloons



Thales Services Numeriques is an ICT company, experienced as a major system integrator in the following markets: Space & Aeronautics, defence, transport, energy, public sector, critical infrastructures, finance and industry. Thales has more than 40 years of background in space industrial systems engineering and in expertise to develop technical, secured by design and high quality software.

COMPETENCIES & CAPABILITIES

- Engineering support (including science skills),
- Large and International Project Management,
- Critical systems development (software and hardware),
- Innovative IT (Big Data, Cloud, HPC...),
- Ground Segment AIV (including space operations support),
- Data center and security management,
- Security Operational Center,
- Hardware and software maintenance (including Third Party Maintenance),
- European quality standards (ECSS), availability, reliability, ergonomy.

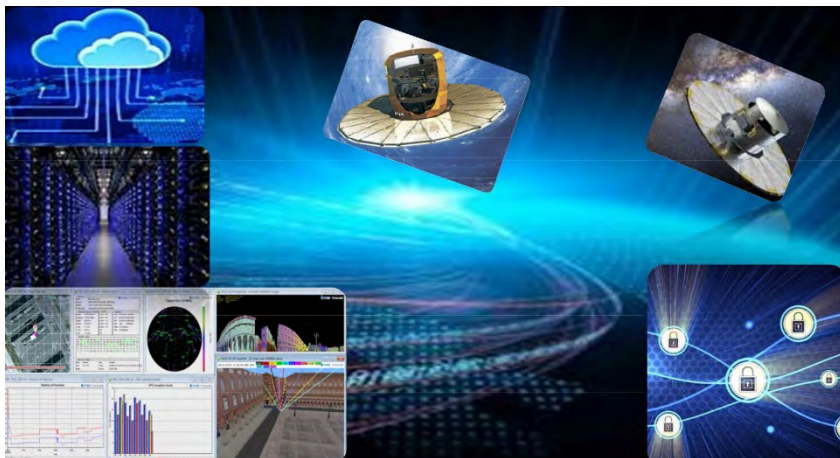

THALES SERVICES NUMERIQUES

PRODUCTS & SERVICES

Space Applications: Flight dynamics, GNSS, Mission Ground Segment, Control Ground Segment, Meteorology, Image Processing, Scientific missions.

Innovative IT: Outsourcing, Machine Learning, Data mining, Big Data, HPC, Cloud, Cybersecurity, Agile life cycle and Continuous Integration.

Products: High Performance Data Flow Orchestration, Security (Vormetric...), Flight Dynamics, Precise positioning, Data Catalogs.

MAJOR SPACE PROJECTS & REFERENCES

UGS (Pléiades, Sentinel 2, GAIA, CSO, MTG L2PF, EPS-SG PDAP...), SCC (OpenSCC, ISIS-CPCC, EGS-CC),

Technical Expertise Center (IASI, Meghatropiques, Sentinel 2, CSO...), GNSS (EGNOS, GALILEO, Precise positioning and indoor/outdoor tracking), FDS (Pléiades, CSO, Gokturk, Science missions...),

Space data valorization (InfoaaS, TEP coastal, NasaWorldWind...).

POINT OF CONTACT

ADDRESS 290 Allée du Lac
F-31670 - Labège - France

WEBSITE www.thalesgroup.com

PHONE +33 (0)5 62 88 86 00

POINT-OF-CONTACT nicolas.dalseno@thalesgroup.com

TURNOVER

WORK FORCE 5,000

SPACE TURNOVER

SPACE WORK FORCE 500

Orbital systems
 Ground segments
 Satellites
 Transversal competencies

THALES

Thales manufactures SESO® Optics & Systems for Space, Lasers, Astronomy & X-Rays in Aix-en-Provence, in France, since 1965.

1st European manufacturer of lightweight Zerodur® Mirrors for Earth observation telescopes, with 166 flight models delivered.

1st manufacturer in the world of X-ray mirrors for Synchrotrons with more than 1500 in operation.

COMPETENCIES & CAPABILITIES

- 2 meter-class optics manufacturing capabilities, including design, grinding, extreme lightweighting, polishing, coating, opto-mechanical assembly & integration, metrology and environmental tests.
- High expertise in Zerodur®, Silica & Silicon polishing
- Polishing : Traditional, Robotic, Magneto Rheology Finishing, Ion Beam Figuring
- Coating : Multidielectric, metallic, space qualified, laser, outdoor



Thales SESO® Space Telescope Primary Mirror - © Thales Alenia Space

Thales - SESO® Optics & Systems

PRODUCTS & SERVICES

Products for Space:

- Lightweight Zerodur Mirrors
- Collimators
- Focal Plane Assemblies
- Cryogenic objectives
- Laser Retro-Reflector Arrays
- Corner Cubes (Hollow or Full)
- Sunshields & cryostat polishing & coating
- Ultra-stable Fabry-Pérot (molecular adhesion)
- Prisms

MAJOR SPACE PROJECTS & REFERENCES

CNES/DGA

- Pleiades, SARAL
- CSO
- TANGO

ESA

- Sentinel 3 & 5, IASI, GAIA, ExoMars TGO, AEOLUS
- MTG Cold Optics, Telescope Optics & Hollow Corner Cubes
- Copernicus : CO2M, CHIME

Most of these projects were run through Thales Alenia Space, some through OHB and Leonardo, and some in direct with CNES/DGA or ESA.

POINT OF CONTACT

ADDRESS 530 rue Frédéric Joliot
13290 Aix-en-Provence, France

WEBSITE www.seso.com

PHONE +33 (0)4 42 16 56 68

POINT-OF-CONTACT : Gilles BORSONI, Director of Sales & Bus Dev,
gilles.borsoni@fr.thalesgroup.com, Mobile +33 (0)6 80 61 82 58

TURNOVER 15 M€

WORK FORCE 119 employees

SPACE TURNOVER 11 M€

SPACE WORK FORCE 87 employees

Orbital systems
Satellites
Transversal competencies



The mission of the French-German company is to democratize space exploration for space and non-space industries. To realize this mission, The Exploration Company develops, manufactures, and operates Nyx, a modular and reusable orbital vehicle which can be refueled in orbit. Nyx serves the low Earth orbit (LEO) and lunar destinations and starts with carrying cargo, with the growth potential to fly humans in the future. The Exploration Company was founded in 2021 by experienced engineers and has recently announced their successful Series A Fundraising of 40.5 M€.

COMPETENCIES & CAPABILITIES

The Exploration Company is the first space exploration enterprise in the world to be privately funded. They are the first company in Europe to reuse their space capsule and the first in the world to use green propellants for such a large space capsule. They are also second in the world to work on cryogenic refueling in Oxygen and Methane for a spacecraft. Finally, they are first in the world to use an open-source operating system and second in the world to use the same core and modular architecture to fit as many destinations as possible (stations around Earth, around the Moon and lunar surface). The company has staffed 50+ professionals with overall 500+ years of space experience.



The Exploration Company

PRODUCTS & SERVICES

The Exploration Company's business model is centred around space logistics: Our spacecraft *Nyx* has the capacity to carry goods, fuel - and in the future, humans - to space stations and lunar surface, and bring them safely back on Earth. Their clients include space agencies and future space stations, but also private clients willing to unleash the potential of space for medical research, developing new materials, and entertainment. Their prototype capsule, *Mission Possible*, will fly in 2024 and is already sold out. The vehicle *Nyx* has three core innovations. Firstly, their spacecraft will make use of green propellants using their in-house developed thrusters. Secondly, their capsule can be reused after entry up to 6 times. Thirdly, their use of Cryogenic orbital engine using Bio-Methane and Oxygen. This engine, called *Huracan*, can be refueled in orbit, can throttle – for lunar landing – and uses an electric pump cycle. *Nyx* will provide an orbital flight service, including power provision, a stable thermal environment, pressurized and unpressurized compartments, and data connection to its customers.

MAJOR SPACE PROJECTS & REFERENCES

The Exploration Company Mission Roadmap:

- 2023: *Mission Bikini*, ballistic re-entry demonstrator, flying with Ariane 6 maiden flight.
- 2024: *Mission Possible*, first recovery demonstrator flying with payloads from clients, flying with SpaceX Falcon9.
- 2026: *Mission Odyssey*, maiden flight of *Nyx Earth*.
- 2028: *Nyx Moon*, maiden flight of *Nyx Moon*.

They currently serve customers such as Airbus, Nanoracks, ESA, CNES & DLR with technology demonstrations in Low-Earth Orbit and on the Moon.

POINT OF CONTACT

ADDRESS 25 rue Marcel Issartier, 33700 Merignac, France

WEBSITE <https://www.exploration.space/>

PHONE +33 06 20 27 24 68

POINT-OF-CONTACT: Pierre FAUCOUP, Chief Revenue Officer

pierre.faucoup@exploration.space, +33 06 20 27 24 68

TURNOVER: 0.1 M€ (estimated in 2022)

WORK FORCE: 51 employees

SPACE TURNOVER: 0,1 M€ (estimated in 2022)

SPACE WORK FORCE: 51 employees

Orbital systems
 Launchers
 Space planes
 Satellites
 Transversal competencies



=

Created in 1958, Thermocoax is a SPIRAX SARCO company since 2019. Thermocoax is a 320 employees company who has a leadership position in designing and manufacturing of temperatures sensors and heating systems based on homemade mineral insulated cable. 70% of the turnover is exported.

Over the last 20 years THX has been a strong player of main space OEMs and Tier companies.

COMPETENCIES & CAPABILITIES

Thermocoax operates on semiconductor, nuclear and aerospace sectors. We design, develop and produce temperatures probes and heating systems. We have our own R&D and Engineering team per sector. We manage prototypes and full qualification programs.

We are ISO-9001, ISO-9100, ISO-14001.

THX has a worldwide footprint with production sites in and 1 new facility located Caligny area in Normandy (France) and Alpharetta, GA(USA).



THERMOCOAX

PRODUCTS & SERVICES

Chemical Propulsion :

- Catalyst bed heater.
- Catalyst bed thermocouple.
- Electronics pressure regulation heater.
- Non-pyrotechnic fuel valve heater.

Electrical Propulsion :

- Magnetic coils
- Heating ring
- Cathode heating plate
- Hollow cathode heater

Thermal Management

- Heating element for heat pipes and Mechanical Pump Loop systems.
- Multispectral camera

MAJOR SPACE PROJECTS & REFERENCES

Venus satellite

Rover CURIOSITY

Planet constellation

Eurostar E3000 & NEO (Eutelsat, SES, Immarsat, Astra..)

Spacebus Neo (SES17, Syracuse IV, Konnect VHTS...)

SKYBOX Planet Constellation

Electrical propulsion: PPS1350 & 5000

Non-toxic Green propellant propulsion : HPGP, Halcyon..

Hydrazine propulsion : MHT1...

POINT OF CONTACT

ADDRESS ZA Normand'Innov- Le Pont de Vère - F61100 – CALIGNY – France

WEBSITE <https://www.thermocoax-space.com>

PHONE +33 (0)1 41 38 80 50

POINT-OF-CONTACT : Olivier HERVE, Global Business Developer Aerospace
+33 7 86 84 77 82

TURNOVER 55 M€

WORK FORCE 320 employees

SPACE TURNOVER 3,5 M€

SPACE WORK FORCE 25 employees

Orbital systems
 Launchers
 Satellites
 Transversal competencies



THIOT INGENIERIE is a private laboratory working in Shock Physics. Nine ultra-instrumented test facilities combined with a numerical simulation center. We also meet aerospace sectors with a dedicated means designed to observing, studying and analyzing the behavior of materials subject to shocks at high strain rates (micrometeoroid or space debris impact).

COMPETENCIES & CAPABILITIES

THIOT INGENIERIE has participated to several project dedicated to determine BLE of space component like MLI. We also participated in numerical simulation project to enhance space reservoir sustainability to HVI impact.

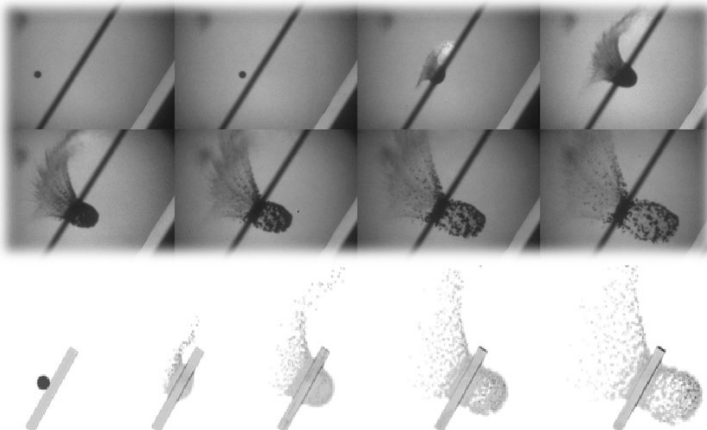

THIOT INGENIERIE

PRODUCTS & SERVICES

We provide :

- Hypervelocity impact (up to 9 to 10km/s)
- Numerical simulation for dynamic threat (HVI impact, blast, ...)
- Laboratory launcher

MAJOR SPACE PROJECTS & REFERENCES

- R&T Project for CNES
- Numerical simulation and material characterization for Pyroalliance
- Numerical simulation for SAFRAN Propulsion

Project cannot be given as we work under NDA

POINT OF CONTACT

ADDRESS 830 Route nationale
46130 PUYBRUN France

WEBSITE www.thiot-ingenierie.com

PHONE +33 (0)5.65.38.36.07

POINT-OF-CONTACT : Romain BOISSON, Business development manager

TURNOVER 4 M€ for equipment delivery – 1 M€ for laboratory services

WORK FORCE 38 employees

SPACE TURNOVER 0,11 M€ (14% of laboratory services)

SPACE WORK FORCE 12 employees

Satellites
Orbital systems
Transversal competencies



ThrustMe is the first mover for iodine-based space propulsion technologies. The company offers advanced motion control solutions for the growing space industry which is facing new challenges due to the rise of satellite constellations. With experts in in-space propulsion and satellite orbital maneuvering strategies, ThrustMe enables a future where space is used sustainably to create value both on Earth, and beyond.

ThrustMe has a complete portfolio of game-changing turnkey propulsion products successfully tested in space and delivered to clients worldwide.

COMPETENCIES & CAPABILITIES

The company benefits from more than 10 years of research experience in the field of plasma physics and space propulsion. Before its creation in 2017, the founders published a total of 75 peer reviewed scientific papers, filed several patents, and gained a solid international reputation as researchers and out-of-the-box innovators with an impressive 20 H-index. At present, the company has a core team of approximately 20 engineers, physicists, and Ph.Ds with demonstrated competence in heterogeneous scientific fields. The team has provided space qualification and verification of several systems in the product line, it has successfully delivered several products to clients, and it has demonstrated the ability to perform batch production and develop market fit products.

FLIGHT READY PROPULSION PORTFOLIO

with all core technologies tested in space

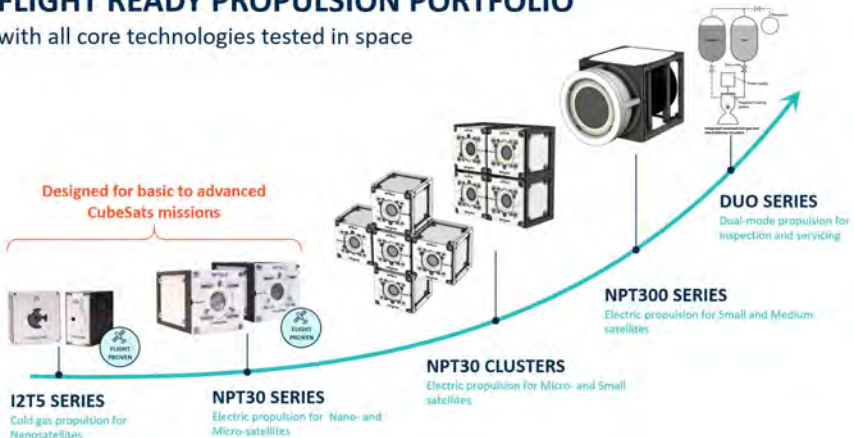

ThrustMe's propulsion products portfolio

THRUSTME

PRODUCTS & SERVICES

ThrustMe develops a complete portfolio of **groundbreaking, turnkey, in-orbit propulsion technologies** for a wide range of platforms and applications. Intelligent operations are combined with safe iodine-based thruster technologies to provide affordable, zero-risks, self-pressurized, and high-performant systems for space mobility. The portfolio includes:

- Cold gas propulsion
- Gridded ion thruster propulsion
- Dual mode propulsion

ThrustMe's products are currently designed to adapt to the stringent requirements of:

- NanoSats
- SmallSats
- MicroSats
- Medium platforms soon

The company also offers **orbital dynamics support** and **scientific instruments** for testing of space hardware.

MAJOR SPACE PROJECTS & REFERENCES

In 2019 and 2020, ThrustMe **made history** with the **first in-orbit demonstrations** of iodine-based cold gas and electric propulsion systems, thus showing the critical role that these technologies have in the era of satellite mega constellations. The company provides robust technology for challenging mission:

- XiaoXiang 1-08: the first iodine-propelled satellite in orbit (I2T5).
- BeiHangKongshi-1: orbit control maneuvering with the first iodine gridded ion thruster ever tested in space (NPT30-I2-1U).
- Hisea-1: SAR platform carrying the NPT30-I2-1U for orbit maintenance, collision avoidance, and end-of-life disposal.
- Napa-2: The I2T5 was selected for orbit maintenance purposes.

... and many more to come!

POINT OF CONTACT

ADDRESS 4bis Rue des Petits Ruisseaux 91370 Verrières-le-Buisson France

WEBSITE <https://www.thrustme.fr>

PHONE +33 (0)1 81 80 49 39

POINT-OF-CONTACT: Dr Aanesland Ane, CEO, ane.aanesland@thrustme.fr

WORK FORCE Approximately 20 employees

SPACE WORK FORCE Approximately 20 employees

Ground segments
Transversal competencies



TimeLink microsystems, a French company based in Toulouse and Brussels is the French leader in the development of complex synchronization systems where time plays a critical role. Since 1978, we offer innovated systems tailored to your needs of an accurate dating and synchronization. We have a wide range of products on shelves as disciplined GNSS constellations, time & frequency generators with full distribution, atomic clocks, NTP/PTP servers, PC time boards and cabinets integration of these instruments.

COMPETENCIES & CAPABILITIES

To develop a very strong partnership with our customers based on shared responsibilities on the full segment of time & frequency on the following markets:

Space: Space agencies/scientific research centers for positioning Systems and Satellites launches

Defence: Shooting guidance systems & equipments for information & transmission

Aeronautics: Localization & Data transmission

Bank and Finance: Time Diffusion, Synchronization

Telecom and Broadcasting: Satellites operators & Services

Energy and Exploitation: Positioning & Synchronization

Data Center: Clock references



SOLUTIONS FOR SYNCHRONIZATION & TIMING



REAL TIME - NEW INDUSTRY 4.0 - AUTOMATION

TIMELINK



MAJOR SPACE PROJECTS & REFERENCES

EUROPEAN LAUNCHERS BASED IN KOUROU (FRENCH GUYANA)

- 3rd generation of Synchronization system (UTC, H0, Countdown generation & distribution) for ARIANE, SOYOUZ and VEGA launchers
- Synchronization of operations and specific gateways for the SOYOUZ launcher (management of Russian Time code and gateways for TsSKB tests Bench)

GROUND SEGMENT OF SATELLITE OPERATORS

- ASTRA, CHINASAT, EUTELSAT, RASCOMSTAR, RSCC, etc.
- EGNOS references clock
- Military references clock

POINT OF CONTACT

ADDRESS 14 rue Jean Perrin
F-31100 - Toulouse

WEBSITE www.timelinkmicro.info

PHONE +33 (0)5 62 87 10 79

POINT-OF-CONTACT: P. Vuillermoz

TURNOVER €2m

WORK FORCE 15

SPACE TURNOVER €1,5m

SPACE WORK FORCE 13

Orbital systems
Satellites
Transversal competencies



For more than 30 years, TRAD Tests & Radiations has been recognized for its unique expertise on radiation effects. On a daily basis, we assist companies wishing to better predict and minimize radiation effects on their products.

We offer a complete range of services and products allowing us to meet all requirements of the radiation process or applicable norms. Located near Toulouse, we have 1600 m² of laboratory space and high-tech equipment.

COMPETENCIES & CAPABILITIES

We propose a complete offer on the whole radiation assurance chain:

- Radiation environment definition / analysis of RHA & other specification documents
- Part sensitivity evaluation: SEE error prediction, applicable radiation test data research & exploitation, TID, TNID tolerance, test plan optimization
- Radiation-oriented 3D modeling: shielding optimization, design validation, etc.
- Radiation software editor in the space, nuclear and medical sectors
- Analysis and solutions: mitigation solution, derating recommendation, etc.
- Electronic component testing: test bench development and test campaigns (TID, TNID, SEE)
- Material testing and characterization: thermal cycling, irradiation campaign, electrical test, etc.
- Sourcing & radiation qualification of electronic components
- Complete and tailored training courses at TRAD or at client's premises
- R&D activities, partnerships with academic entities and agencies



Testing and analysis of radiation effects
on components, materials and electronic systems

TRAD

PRODUCTS & SERVICES

We bring our expertise by offering a large and complementary panel of services:

- Electronic components radiation testing, materials characterization, component expertise (EEE)
- Test bench development for TID and SEE on basic to complex integrated circuits, memories, ASICs, FPGAs, etc.
- Technical assistance to radiation, facilities rental incl. Co60 and Vacuum
Electron irradiation facilities
- Sourcing of reliable and durable EEE components qualified to radiations (Dose and destructive single effects)
- A wide range of industry-specific software: FASTRAD® & OMERE (space applications), RayXpert® (nuclear & medical)
- On-site training courses for dose calculation, radiation space environment, radiation effects on components & materials, etc.

MAJOR SPACE PROJECTS & REFERENCES

Mission LAPLACE, Mission PHOIBOS, Mission JUICE, équipements ICARE (satellites JASON et SACD), GLOBALSTAR, IRRIDIUM, PLEIADES, GALLILEO, ONEWEB, etc.

We are proud to assist major companies and agencies worldwide such as: 3D Plus, Airbus DS, CERN, CNES, E2V, ESA, IRSN, ISS-Reshetnev, NASA-JPL, Sagem DS, Sofradir, STMicroelectronics, TESAT Spacecom, Thales Alenia Space, etc.

We also cooperate with international laboratories & universities such as The MIT, Hepia, The MIT, LANL, etc.

POINT OF CONTACT

ADDRESS 907 voie l'Occitane
F-31670 - Labège - Cedex - France

WEBSITE www.trad.fr

PHONE +33 (0)5 61 00 95 60

POINT-OF-CONTACT: Christian Chatry

TURNOVER > €8.4M

WORK FORCE 70

SPACE TURNOVER > €7.4M

SPACE WORK FORCE 60

Orbital systems
Launchers
Satellites
Ground segments
Balloons
Transversal competencies

TRONICO
ALCEN

Founded in 1973, TRONICO specialises in the design, manufacturing and assembly of complex electronic products on behalf of others, throughout the product's life-cycle. In addition to its core business of EMS (Electronic Manufacturing Services), TRONICO is positioned as ODM (Original Design Manufacturer) in the development of complex systems. TRONICO pursues a strategy of high innovation supported by its « Innovation Centre » (composed of science doctorate graduates) and its R&D department (70 engineers).

COMPETENCIES & CAPABILITIES

- Design office
- Co- Development & Industrialization : DFM Manufacturing - DFT Testability - DTC Cost
- Test Bench design & manufacturing
- Component laboratory: Cross Section , LAT (Lot Acceptance Test) requirements
- Manufacturing in environment controlled - Dedicated Clean Room ISO 7
- Long term storage of strategic components
- **12000** sq m.



TRONICO

PRODUCTS & SERVICES

- System architecture, electronics and mechanical design
- Industrialization study, components engineering, test bench development
- Prototyping, qualification, certification
- Industrial transfer to manufacturing
- PCB Assembling (SMD, cable wiring, wrapping)
- Burn-in, RCT, chocs, Tests (in situ, functional, flying probes tests)
- Integration
- Repairing, End of life support, Obsolescence management, Safe & long term storage

MAJOR SPACE PROJECTS & REFERENCES

- Airbus Defense & Space
- Ariane Group
- SABCA
- SAFRAN
- Thales Alenia Space
- SAFT

POINT OF CONTACT

ADDRESS Rue du Bocage, 26
Saint-Philbert-de-Bouaine, France

WEBSITE www.tronico-alcen.com

PHONE +33 (0)2. 51 41 91 35

POINT-OF-CONTACT : Denis JEHANNO, Key Account Manager,
djehanno@tronico-alcen.com, +33(0) 6 74 97 44 34 - +33(0) 2 51 24 41 53

TURNOVER 82 M€

WORK FORCE 800

SPACE TURNOVER 4 M€

SPACE WORK FORCE 40

Transversal competencies



United Monolithic Semiconductors (UMS) is the European leader in offering RF MMIC products and foundry services for specialised markets, including Defence and Space, Telecommunications, Automotive Radar and Industrial Sensors.

COMPETENCIES & CAPABILITIES

- Space evaluated technologies with GaN and GaAs processes from DC to 100GHz: Low noise and power pHEMT, HBT, Schottky diode, MESFET GaN HEMT
- MMIC assembly in hermetic metal ceramic SMD package: Hermetic sealing, Space qualified assembly process and space documentation, Traceability, Compatibility with many parts of our catalogue.

For flight models delivery, UMS is used to handle all the required WAT/LAT qualification processes according to space standards, for both catalogue products or MMIC designed by customers in foundry mode.



United Monolithic Semiconductors

PRODUCTS & SERVICES

UMS has a comprehensive offer based on the supply of either ASIC or catalogue products, in the main based on the Company's internal III-V technologies and through the provision of a comprehensive foundry service which allows customers to directly create their own product solutions.

The full range of catalogue products from DC to 100GHz is based on GaAs, GaN, SiGe technologies and encompasses Power Amplifiers up to 200W, mixed signal functions, very Low Noise Amplifiers, and complete transceiver systems. These products are offered in die form but are more commonly packaged and in multichip module form.

Our GaAs and GaN processes provide the technology platform to allow the design of our leading edge products and form the basis of our foundry service offer to external design centres.

MAJOR SPACE PROJECTS & REFERENCES

UMS has a reputation for and a long heritage in supplying high quality products to the most demanding markets. UMS is ISO 9001, ISO 14001 and ISO TS16949 certified. The majority of the UMS III-V internal technologies is approved for Space use and is part of the ESA EPPL list.

UMS delivered qualified parts in most of the Space Programs such as: GALILEO, OneWeb, Biomass, GISAT-1, MADRAS, FLIP, RADARSAT2, COSMO, Sentinel,

POINT OF CONTACT

ADDRESS : Bâtiment Charmilles - 10 Avenue du Québec
91140 Villebon sur Yvette - France

WEBSITE www.ums-rf.com

PHONE +33 (0)1 69 86 32 00

POINT-OF-CONTACT : Leclerc, Eric, Marketing Manager
eric.leclerc@ums-rf.com, +33.1.69.86.32.96.

TURNOVER

WORK FORCE: 416 employees

SPACE TURNOVER

SPACE WORK FORCE

Orbital systems
Satellites
Ground segments
Transversal competencies



U-Space is a French company created in February 2018 in Toulouse. It was co-founded by Fabien Apper, Antoine Ressouche and Nicolas Humeau, all three graduated from engineering schools (ISAE – SUPAERO, ENAC, École des Mines). They are space experts.

The journey began with the team of engineers who worked on EyeSat. Then, U-Space has never stopped growing.

COMPETENCIES & CAPABILITIES

U-Space designs, builds and operates nanosatellites. The company provides customized and high-performance nanosatellites through its advanced technologies. The team supports you from the project study to turn your spatial mission idea into an operational project.

U-Space's expertise is based on 5 years of experience within the French Spatial Agency (CNES). This legacy allowed the team to work on some of the best innovations in the world for the past few years.

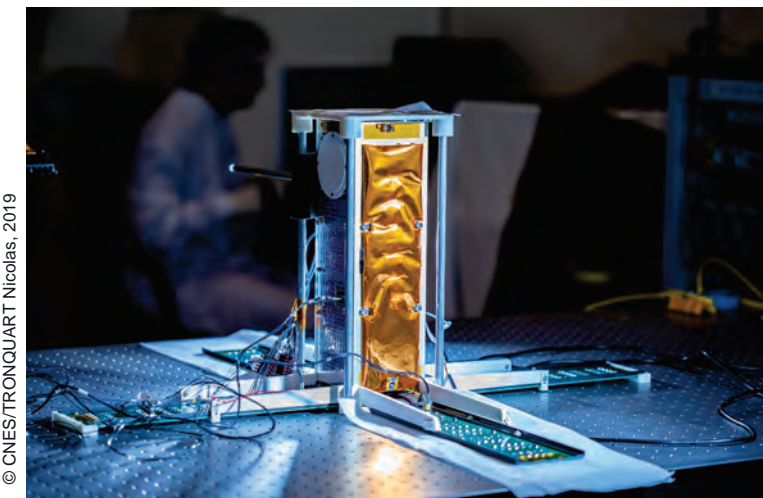

U-SPACE

PRODUCTS & SERVICES

U-Space provides 3 services:

- **The mission design:**

U-Space has developed its own software to lead tests to make hypothesis about your mission. Based on those hypotheses, the team is able to establish the design, the costs and the schedule of your project.

- **The production:**

Right after your mission design, U-Space builds your future nanosatellite thanks to the study. In addition to the construction, the team tests your nanosatellite under the same condition as in orbit.

- **Operations:**

Once your nanosatellites are in orbit, U-Space can operate them and recover your mission data. The data that you'll get is clear and mission oriented.

MAJOR SPACE PROJECTS & REFERENCES

- **EyeSat:**

On December 18, 2019, a 3U nanosatellite was orbited by Arianespace from the Guiana Space Center. EyeSat aims to study the zodiacal light and the Milky Way through a miniaturized space telescope.

- **N3SS:**

N3SS is a 3U nanosatellite that monitors the civil radio frequency spectrum L and S-band and analyzes sources of interference.

- **Partners and supporters:** ESA, CNES, Airbus, Aerospace Valley, ...

POINT OF CONTACT

ADDRESS 3 rue Tarfaya 31400 Toulouse, France

WEBSITE www.u-space.fr

PHONE +33 (0)7.88.03.77.68

POINT-OF-CONTACT: Fabien APPER - CEO

fabien.apper@u-space.fr - +33 (0)7.88.03.77.68

TURNOVER

WORK FORCE 14 employees

SPACE TURNOVER

SPACE WORK FORCE 14 employees

Launchers
 Orbital systems
 Satellites
 Balloons
 Space planes
 Transversal competencies



VENTANA Group now consists of 13 companies divided into 3 divisions: Mechanical, Sheet metal work and Foundry with complementary synergies, in an integrated and evolving organization.

Thanks to strong independent shareholders, VENTANA has invested more than 20 M€ over the last 10 years to prepare the future to be at the service of its customers.

COMPETENCIES & CAPABILITIES

Our mission: To conceive and implement efficient manufacturing processes, which are increasingly more respectful of people and the environment, for high value added metal components and sub-assemblies.

Our fields of excellence serve the most demanding industries such as aviation, space, defence, energy and motor sports.

1100 employees

50 crafts

13 subsidiaries

5 countries (France, Austria, Portugal, Sweden and Tunisia)



COMPANY NAME

PRODUCTS & SERVICES

Machining: All technologies with sizes from small to large
High Precision / Assembly workshop
Skills: mass, foundry, forge or additive manufacturing

Foundry: All metals except titanium / Sand Plaster investment casting
All dimensions & weights
Printing of sand foundry molds by 3D printer
Control by 3D scan, digital radiography / penetrant testing

Welding / Sheet metal Working:
All Metals and All dimensions
All welding technologies (TIG / MIG / Plasma / Laser...)
Folding, rolling, hot / cold stamping, bending, riveting...

Subsidiaries specialized in prototyping / medium / large series
Qualification: ISO9001, EN9100, NADCAP (CND - Welding - Laser) and COFREND

MAJOR SPACE PROJECTS & REFERENCES

Customers:

ARIANEGROUP, THALES ALENIA SPACE, AIRBUS DEFENSE & SPACE...

Programs:

CSO, Iridium, Ariane 5 et 6, STD, CryoSat, SGD, PAP, MQV...

POINT OF CONTACT

ADDRESS ZI du Pont (Headquarter)
64510 Narcastet France

WEBSITE <https://www.ventana-group.eu/en/>

PHONE +33 (0)5 59 82 11 44

POINT-OF-CONTACT : Arnaud CRUCHET, Chief Business Development Officer
Arnaud.CRUCHET@ventana-group.eu, Mobile: +33 673 661 885

TURNOVER 90 M€

WORK FORCE 1100 employees

SPACE TURNOVER 2 M€

Satellites
Transversal competencies



Vignal Artru Industries is a company specialized in machining mechanical parts with a high level of precision parts in aeronautics, spatial and medical device for 60 years.

We have two production plants, 70 people in France near Valence and 30 people in Tunisia at BEN AROUS (plant qualified by DAHER VALVES). This organization allows us to offer a technical service but also a Best Cost solution.

COMPETENCIES & CAPABILITIES

- Machining (Numerical machining centers 5 axes / 5 axes HSM / 4 axes, turning / milling centers type Integrex)
- Fitting (deburring, shelving to hydromechanical standards, sharp angles on flaps, tribofinishing)
- Grinding and honing (flat and cylindrical)
- Non-destructive control , three-dimensional check and geometric measurement
- Riveting (dash rivet, rivet type bouterole)
- Assembly (assembly of sub-assemblies, shrink-wrapping, loctite and bi-component gluing, sealant)



Vignal Artru Industries

PRODUCTS & SERVICES

- **Aeronautics:** We are specialized in the manufacturing in Hydraulic blocks (TP400/M88/ARRIEL 2D Jacks/ Hydraulic cylinders (GE90/M88) Spool/sleeve matched M88/SAM 146).
- **Medical:** Manufacture and assembly of CARMAT artificial heart pump.
- **Space:** waveguides, Optical supports for satellite measurement equipment

MAJOR SPACE PROJECTS & REFERENCES

- IASI
- METOP
- EUCLID Project

We work for AIRBUS DEFENCE AND SPACE & ARIANE GROUP

POINT OF CONTACT

ADDRESS 335 Route de MOBOS
26120 Chabeuil - France

WEBSITE www.packaero.com

PHONE +33 (0)4 75 59 04 55

POINT-OF-CONTACT : PEPIN Alexandre, head of operations,
alexandre.pepin@vignal-artru.com, 04 75 59 04 55 / 06 43 54 38 43

TURNOVER 6 M€

WORK FORCE 59-99 employees

SPACE TURNOVER 0,55 M€

SPACE WORK FORCE 70 employees

Launchers
Satellites
Transversal competencies



Vishay manufactures one of the world's largest portfolios of discrete semiconductors and passive electronic components that are essential to innovative designs in the automotive, industrial, computing, consumer, telecommunications, military, aerospace, and medical markets. Serving customers worldwide, Vishay is The DNA of tech.™ Vishay Intertechnology, Inc. is a Fortune 1,000 Company listed on the NYSE (VSH). More on Vishay at www.Vishay.com.

COMPETENCIES & CAPABILITIES

Vishay manufactures one of the industry's broadest lines of military-qualified resistors and capacitors, as well as a number of other components that meet the stringent needs of military and aerospace customers. Vishay components are used in aircraft flight, cockpit, and cabin equipment; unmanned aerial systems; drones; navigation and weather satellites; radar and sonar units; radio and satellite communications; guidance systems; deep space exploration; and more.



VISHAY Sfernice

PRODUCTS & SERVICES

VISHAY is one of the world's most trusted manufacturers of electronic components. From discrete semiconductors to passive components, from the smallest diode to the most powerful capacitor, Vishay's breadth of products constitutes the very foundation that brings modern technology to life, every day, for everyone. We call it The DNA of tech.™

Vishay is well-positioned to propel such timely macroeconomic growth drivers as sustainability, connectivity, and mobility. Through R&D, manufacturing, engineering, quality, sales, and marketing, we generate the essential components that enable inventors and innovators to create new generations of products—ones that span many sectors: automotive, industrial, consumer, computer, telecommunications, military, aerospace, and medical.

Together with the manufacturers of today's and tomorrow's most compelling electronic innovations, we are enabling next-level automation in factories, the electrification of the automobile, 5G network technology, and the rapid expansion of connectivity across everything (IoT) to highlight a few areas of strong growth.

MAJOR SPACE PROJECTS & REFERENCES

Through its SFERNICE division (ESCC QML), VISHAY has been serving the space market for more than 3 decades.

Customers include Airbus D&S, Alter, EADS-SODERN, Honeywell, JPL, NASA, Lockheed Martin, RUAG Aerospace, Safran, Thales, Thales Alenia Space, Tesat, BAE Systems, Crisa, Collins Aerospace, Cobham and others.

Programs include Exomars Rover, Planck, Hubble, Galileo, Hydra, Ariane, SOHO, Helios, Hotbird, MARS & VENUS Express, Rosetta, ICARE, Hotbird, Inmarsat, Skynet, Columbus, Juice, Plato, Leonardo, Cosmo, Smile, Geonext, Telsat ...

POINT OF CONTACT

ADDRESS 199 Boulevard de la Madeleine
06000 Nice

WEBSITE <https://www.vishay.com/company/brands/sfernice>

PHONE +33 (0) 4 93 37 27 27

POINT-OF-CONTACT : DHIA, Amine, Senior Manager Product Marketing
amine.dhia@vishay.com, +33 (0) 4 93 37 28 98

TURNOVER 100,580 M€

WORK FORCE 1,100 employees

SPACE TURNOVER 1,621 M€

SPACE WORK FORCE 13 employees

Transversal competencies



VisioTerra is a SME specialized in Earth Observation. The ambition is to offer solutions and geoservices to the widest audience (scientists, public authorities, NGOs, companies, citizens) enabling an easy use of satellite data. VisioTerra is a member of the Copernicus Academy.

COMPETENCIES & CAPABILITIES

VisioTerra engineers and doctors have skills in computer and geographic sciences. A part of the team is focused on software developments and another on thematic services.

Thanks to the mix of these skills, VisioTerra was able to develop the **FLEGT Watch** service dedicated to the monitoring of the forests in 8 African countries. This service, funded by EU, analyzes Sentinel-1/2 data and sends alerts to the users (rangers, parks managers, independent observers) each time deforestations are detected in order to avoid illegal logging.

For the automatic analysis of detected events, VisioTerra has developed skills in **AI** and especially in **machine learning**.

Thanks to its in-house infrastructure (storage 1PB, 1GB/s symmetric fibre), VisioTerra can act as a **Data Processing Relay** between data providers such as ESA, USGS, CNES, JAXA... and end-users.

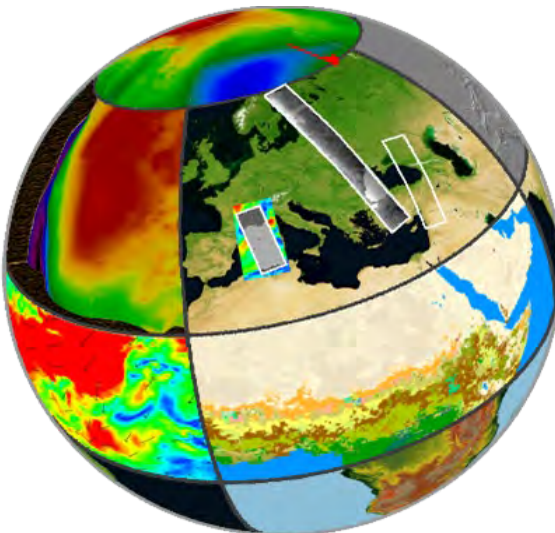

VisioTerra

PRODUCTS & SERVICES

VisioTerra offers 5 main activities:

- Software developments supporting “**geoservices**”
- Scientific consulting
- Spacemaps production
- Training
- Communication

VisioTerra own platform called **VtWeb** is an **advanced solution of visualisation and processing of free Web data**: satellite data, weather, climate and bio-geophysical data, LU/LC maps, DEM/DSM...). The VtWeb users can access to this great variety of data, process them on-the-fly, visualise them in 2D/3D in all Web browsers, share and export the selected data in GIS.

VisioTerra develops **VtDaws (Detection and Warning Services)** for Agriculture, Forestry, Water Management and Oil&Gas sectors. The objective is to automatically monitor areas, detect events (e.g. hydric stress of the plants, deforestations, obstructions to the navigability, offshore oil spills), and send warning/alerts and informative dashboards.

MAJOR SPACE PROJECTS & REFERENCES

- **ESA Scientific Missions**: VisioTerra has derived from VtWeb the systems for the processing and the visualization of data acquired by the **CryoSat, Goce and Swarm** satellites.
- **ESA & CNES**: Development of HEDAVI (HEritage DAta of **ERS** and **Envisat** satellites) for **ESA** and **SPOT** World Heritage for **CNES**. These systems allow the visualization of past missions data.
- **Copernicus**: use of all the **Sentinel** and **Copernicus Services** data in the offered **geoservices** and software systems described above.
- **Sentinel Vision Service**: Daily edition for **ESA** of the “**Sentinel** of the Day” and “Event Sheets” showing the potential of **Sentinel** images and altimeter data. Design of thematic galleries.
- **Detection of fires and burnt areas** in Sudan and Chile using the data of **Proba-V** satellite.

POINT OF CONTACT

ADDRESS 14 rue Albert Einstein
77420 CHAMPS-sur-MARNE - FRANCE

WEBSITE www.visioterra.fr

PHONE +33 (0)9 61 30 66 2

POINT-OF-CONTACT Gisquet Philippe, Business Development,
philippe.gisquet@visioterra.fr, +33 (0)6 67 62 21 04

TURNOVER 0,6 M€

WORK FORCE 13

SPACE TURNOVER 0,6 M€

SPACE WORK FORCE 12

Orbital systems
Launchers
Satellites
Ground segments
Balloons
Transversal competencies

VIVERIS

Viveris is a French company specialized in advanced technologies (840 engineers / 76M€ of turnover in 2022).

We have developed a pole of competence in spatial industry, especially in spatial telecommunication domain.

COMPETENCIES & CAPABILITIES

Specialized in network architecture and development for GEO and LEO systems, we have strong experience on both **ground segment** (in partnership with Key account customers such as THALES ALENIA SPACE, AIRBUS DS, etc.) and **on-board segment (especially by actively participating on research programs in collaboration with specialized research laboratories).**

We provide global solutions, from hardware design to applicative software development, including BSP/OS, low layers and network stacks development or customization.



VIVERIS

PRODUCTS & SERVICES

VIVERIS supports customers on all or parts of the phases of development of a product (from requirements to validation through architecture implementation, development, test and integration).

Able to work through a standard V Cycle, VIVERIS has also a strong experience on AGILE process (SCRUM).

MAJOR SPACE PROJECTS & REFERENCES

End user telecommunication BOX with smart satellite link integration (World wide deployment by major telecommunication operator for more than 10 years)

Operator ground segment and End user modem development for next telecommunication satellite generation (VHTS) (5 years)

R&D Teams working on telecommunication research program (15 years)

- OPENSAND, OPENBACH, ROHC, SNS3 Libraries
- DVB-S2 bidirectional R&T, Satellite Hybridization, QoS
- SATCOM virtualization.

POINT OF CONTACT

ADDRESS Parc Technologique du Canal - 1 avenue de l'Europe
31400 TOULOUSE - France

WEBSITE www.viveris.fr

PHONE +33 (0)5 61 00 30 80

POINT-OF-CONTACT : GUELMINGER, Pierre, Director of Toulouse agency
pierre.quelminger@viveris.fr, +33 5 61 00 31 82

TURNOVER 76 M€

WORK FORCE 840

SPACE TURNOVER 25 M€

SPACE WORK FORCE 240

Launchers
Satellites
Transversal competencies



WATT&WELL operates as a power electronics equipment provider for companies manufacturing space launchers and satellites. Our mission is to step-change the space market with lower recurring costs for high efficiency motor controllers, power supplies, and fail-operational controllers. Beyond its engineering expertise, WATT&WELL is EN9100 compliant and compliant to ECSS standards where required, it manages the full product lifecycle from design to manufacturing.

COMPETENCIES & CAPABILITIES

- Competencies:
 - Motor control
 - Power supply topologies
 - Control & data acquisition
 - Fail operational architectures
 - DAL A/B design
 - PCB and component development per ECSS standards
- Capabilities:
 - Development of hardware, FPGA, software (DAL A/B) from prototyping, simulation, industrialization to production and support



WATT&WELL

PRODUCTS & SERVICES

- Products:
 - Motor controllers (1 to 10 kW)
 - Power supplies (1 to 10 kW)
 - Control & data acquisition
 - Fail operational systems
- Services:
 - Design - hardware, FPGA, software (DAL A/B)
 - Prototyping
 - Simulation
 - Industrialization
 - Assembly & test
 - Production
 - Test benches
 - Support

MAJOR SPACE PROJECTS & REFERENCES

- Ariane 6 Fail Operational Motor Controller
 - ArianeGroup
- Confidential Defense Project
 - ArianeGroup, DGA

POINT OF CONTACT

ADDRESS 129 avenue de Paris
91300 Massy, France

WEBSITE <http://www.wattandwell.com>

PHONE +33 7 88 21 91 88

POINT-OF-CONTACT : Nicolas Pacault
Aerospace & Defense Business Unit Director

TURNOVER 5 M€

WORK FORCE 50 employees

SPACE TURNOVER 2 M€

SPACE WORK FORCE 20 employees

Transversal competencies



Weeroc is fabless semiconductor company designing and selling analogue and mixed signal integrated circuits. Weeroc has a strong expertise in radiation hardened ICs, analogue design, high voltage design and photodetectors read-out chain. Weeroc also designs ASICs based on customer specifications.

COMPETENCIES & CAPABILITIES

- Low noise, high-speed analogue microelectronics
- Photodetector read-out chips, single photon detection, photon time of flight measurement, LIDAR
- High voltage microelectronics
- Radiation hardening by design, standard cell library hardening
- Radiation measurement
- Scientific instrumentation



WEEROC

PRODUCTS & SERVICES

- End-to-end ASIC design from requirement specification to qualified parts (Class 1 QMLV grade, New Space grade, evaluation grade)
- Portfolio of silicon proven and qualified IPs in different technologies for fast and low risk design
- Catalogue of space COTS (ongoing)

MAJOR SPACE PROJECTS & REFERENCES

- Design of MIL-1553 bus transceivers
- Design of a spacegrade LIDAR read-out ASIC for Europa Lander mission
- Design of a spacegrade LIDAR read-out ASIC using SiPM
- Design of analogue IPs for qualified technology
- Design of an electronic circuit breaker for satellite power rails

POINT OF CONTACT

ADDRESS 4 Avenue de la Baltique, Mosaic Parc Courtaboeuf, Bat Acacia
91140 Villebon sur Yvette France

WEBSITE www.weeroc.com

PHONE +33 (0)1 85 41 13 90

POINT-OF-CONTACT : FLEURY Julien, president, julien.fleury@weeroc.com
+33 (0)1 85 41 13 90

TURNOVER 0.7 M€

WORK FORCE 12 employees

SPACE TURNOVER 0.3 M€

SPACE WORK FORCE 6 employees